

# **iQUBE ELECTRIC**



**Hello iQuber,**

**Congratulations!**

*You are now the proud owner of iQube electric scooter from the house of TVS Motor.*

*The iQube is a scooter like no other. It is a seamless blend of both sustainability and performance. Delivering an incredibly low carbon footprint, the iQube comes a conscience towards the environment. Not just that, it's pretty zippy for a scooter that runs on alternative energy.*

*For getting the best out of this technology, please read the manual carefully and understand all features and operations of your TVS iQube. Follow the instructions and enjoy an intelligent and eco-friendly experience.*

*To always ensure a care-free journey on your TVS iQube, we urge you to get your TVS iQube serviced only at TVS Motor Company Authorized Dealers.*

*We hope you enjoy every aspect of being an iQuber and being part of our community of next gen sustainable riders.*

**TVS MOTOR COMPANY LIMITED**

Under any circumstances, TVS Motor Company Limited will be glad to provide any additional information or service assistance you require. Please feel free to contact us at our area offices:

#### TAMILNADU-1, 3 & 4

##### 1. TVS Motor Company Limited

V Floor, Gee Gee Universal,  
No. 2, MC Nichols Road,  
Chetpet, Chennai - 600 031.  
Phone : 044-28361651/28361654  
Email : AO.Chennai@tvs motor.com  
AO.Madurai@tvs motor.com

#### TAMILNADU-2

##### 2. TVS Motor Company Limited

No. 10, 2nd floor,  
Shree Shanmugapriya Towers,  
Kannuswamy Street,  
Behind Hotel Annapoorna,  
R S Puram, Coimbatore - 641 002.  
Phone : 0422-4350060/2541035  
Email : AO.Coimbatore@tvs motor.com

#### KERALA

##### 3. TVS Motor Company Limited

Ambady Towers, Second Floor,  
Door No. 27/631, A6,  
Edappally-Pookkattupady Road,  
Edappally PO., Cochin - 682 024.  
Phone : 0484-2544578/2556938  
Email : AO.Cochin@tvs motor.com

#### KARNATAKA-1, 2 & GOA

##### 4. TVS Motor Company Limited

No. 600, Anand Surya, 2nd Floor,  
15th Cross, 6th Phase, JP Nagar,  
Opp. BMTC Bus Stop,  
Bangalore - 560 078.  
Phone : 080-26653433  
Email : AO.Bangalore@tvs motor.com

#### ANDHRAPRADESH-1 & 2

##### 5. TVS Motor Company Limited

Rukumani Towers, First Floor,  
No. 3-11-30, Plot No. 11,  
Paigha Colony, Behind Anand Theater,  
Secunderabad - 500 003.  
Phone : 040-27840590/27844419  
Email : AO.Hyderabad@tvs motor.com  
AO.Vijayawada@tvs motor.com

#### MAHARASHTRA-1 & 2

##### 6. TVS Motor Company Limited

No. 401, 4th Floor, The Chambers,  
Plot No. 4/12/3, Near Ganapati Chowk,  
Viman Nagar, Pune - 411 014.  
Phone : 020-26632111/26632110  
Email : Service.pune@tvs motor.com

#### MAHARASHTRA-3 & CHATTISGARH

##### 7. TVS Motor Company Limited

No. 502B, 6th Floor, B Wing,  
Shriram Shyam Towers,  
Near LIC Square, Sardar,  
Nagpur - 440 001.  
Phone : 0712-2569932  
Email : Service.Nagpur@tvs motor.com  
AO.Raipur@tvs motor.com

#### GUJARAT

##### 8. TVS Motor Company Limited

1208-1213, Shivalik Satyamev,  
Below Bopal Over Bridge,  
Ambli-SP Ring Road Junction, Bopal,  
Ahmedabad- 380058.  
Phone : 079-65443748  
Email : AO.Ahmedabad@tvs motor.com

#### MADHYA PRADESH-1 & 2

##### 9. TVS Motor Company Limited

No. 211-212, 2nd Floor,  
Chinar Incube Business Centre,  
Chinar Fortune City,  
Near Brindhavan Dhaba,  
Hosangabad Road,  
Bhopal - 462 026.  
Phone : 0755-2499406/2499306  
Email : AO.Bhopal@tvs motor.com  
AO.Indore@tvs motor.com

#### RAJASTHAN-1 & 2

##### 10. TVS Motor Company Limited

Plot No. 17-18,  
2nd Floor of National Motors Building,  
Jhotwara Industrial Area,  
Jaipur - 302 012.  
Phone : 0141-5150901/5150902  
Email : AO.Jaipur@tvs motor.com  
AO.Udaipur@tvs motor.com

## DELHI & HARYANA

### 11. TVS Motor Company Limited

D-3 & D-4, 2nd Floor,  
Sector - 10, Noida,  
Uttar Pradesh - 201 301.  
Phone : 011-29834640/29834773  
Email : AO.Delhi@tvsmotor.com

## PUNJAB & CHANDIGARH

### 12. TVS Motor Company Limited

4th Floor, Royal Business Park,  
Chandigarh Ambala Highway,  
Zirkapur - 140 603.  
Phone : 01762-464777/465777  
Email : AO.Chandigarh@tvsmotor.com

## UTTAR PRADESH WEST

### 13. TVS Motor Company Limited

D-3 & D-4, 2nd Floor,  
Sector - 10, Noida,  
Uttar Pradesh - 201 301.  
Phone : 011-29834640/29834773  
Email : AO.Delhi@tvsmotor.com

## UTTAR PRADESH CENTRAL & EAST

### 14. TVS Motor Company Limited

1st Floor, Cyber Tower, TC-34/V-2,  
Vibhuti Khand, Gomti Nagar,  
Lucknow - 226 010.  
Phone : 0522-4918300/4918301  
Email : AO.Lucknow@tvsmotor.com

## WEST BENGAL

### 15. TVS Motor Company Limited

Ground Floor & First Floor,  
133 A. S. P. Mukherjee Road,  
Opp. Tollygunge Police Station,  
Kolkatta - 700 026.  
Phone : 033-24617096/24617092  
Email : AO.Kolkatta@tvsmotor.com

## BIHAR

### 16. TVS Motor Company Limited

N-Plaza, Jamal Road,  
P.S. Kotwali,  
Patna - 800 001.  
Phone : 0612-2200068/2200069  
Email : AO.BNJ@tvsmotor.com

## ORISSA & JHARKHAND

### 17. TVS Motor Company Limited

No. 303, 3rd Floor,  
Creative Plaza, Rasulgarh,  
Bhubaneshwar - 751 010.  
Phone : 0674-2580019  
Email : AO.Bhubaneshwar@tvsmotor.com

## NORTH EAST STATES

### 18. TVS Motor Company Limited

147, Udayan, Ganesh Guri,  
Opp. Punjab National Bank,  
R G B. Road, Guwahati - 781 005.  
Phone : 0361-2202030/2202031  
Email : AO.Guwahati@tvsmotor.com

Or

**Toll Free Number Relationship Manager : 1800-572-1818 (Mon - Fri: 9 am to 6 pm)**

**Toll Free Number Roadside Assistance : 1800-258-7111 (Available 24 x 7)**

**Email : [customercare@tvsmotor.com](mailto:customercare@tvsmotor.com)**



## INTRODUCTION

One of the finest and modern technology products of TVS Motor is waiting to be unveiled; an electric scooter which is futuristic and contains plenty of features and technological advancements. However, before delving further into this manual, let us first have a glimpse of what your electric two wheeler is and how it is different from an internal combustion engine powered vehicle. The below info-graphic provides a broad idea about an electric two wheeler;

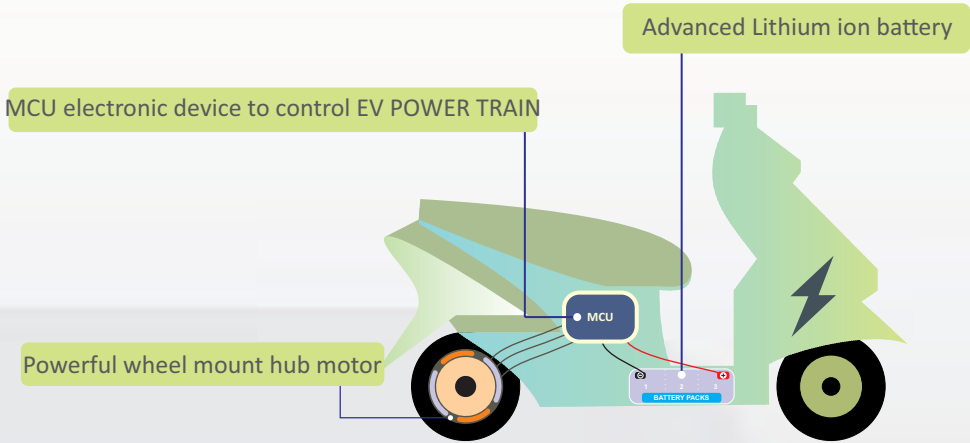

# VS

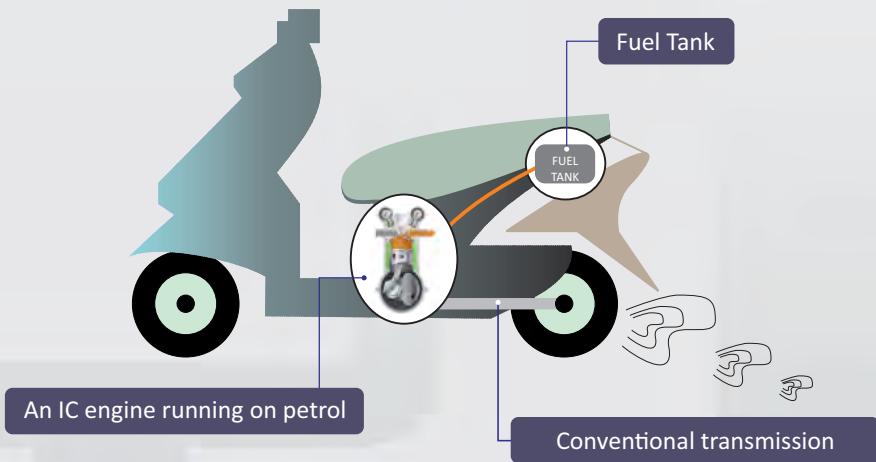

Operating this vehicle safely is an important responsibility of the rider. To help you make safe decisions while operating the vehicle, we have provided necessary operating procedures and other information in this manual. This information alerts you on potential hazards that could cause injury to you or others. Since it is not possible to warn you about all the hazards associated with operating or maintaining the vehicle, you must use your own judgement.

You will find important safety information in following form in this manual. These words carry the following connotations:

### **Note**

This message provides further clarification for **clear understanding of any particular**

### **Caution**

This message indicates special procedures or precautions to be followed to **avoid damage to the vehicle.**

### **Warning**

Disregarding this message might result in **accidents or injury to the rider.**

### **Note**

- This manual should be considered as a permanent part of the vehicle and should remain with the vehicle when resold or transferred to a new owner.
- All information, illustrations, photographs and specifications contained in this owners manual are based on the latest product information available at the time of this publication. TVS Motor Company Limited may, however, incorporate modifications or improvements on its vehicles at any time without notice and therefore, in such events it is possible that the relevant part of the owner's manual does not apply to your vehicle.
- Prior permission of TVS Motor Company Limited is required for quoting, copying or reproducing any part of the owner's manual.
- Accessories shown in the picture may not be part of the standard equipment.
- Pictures shown in this manual are of TVS iQube Disc Brake version unless specified.



## **Caution**

1. Leaving the ignition cum steering lock in 'ON' position for a prolonged time will drain the battery when the vehicle is not in use. Switch OFF and take the key out when the vehicle is not in use.
2. Always lock the steering while parking for safety.
3. It is recommended to use the tool kit in case of emergency only. It is always advisable to take your vehicle to TVS Motor Company Authorized Main Dealer.
4. Never sit on vehicle when it is supported by stands.
5. Utility box can be used to carry a load of 10 kg maximum.
6. Do not carry perishable items inside the utility box. It is not fully sealed. Do not allow / spray water to get inside the utility box. Take care not to spill fluid into the utility box.
7. Care should be taken not to attach the luggage which hangs out of your scooter. Please note that the luggage attached to your scooter should not interfere your feet movement.
8. The charging time of the vehicle may vary, depending on the vehicle's battery state of charge.
9. The flap has been designed to prevent water entry inside the charging port and is not replaceable. No warranty for charger in case of flap damage.
10. Ensure that the utility box light glass is not damaged while accessing the utilities. Do not slam / forcefully close the seat as it may permanently damage the utility box light switching mechanism.
11. Always release the side stand to its full up position before moving the vehicle.
12. Don't give throttle or apply while vehicle is doing self-check.
13. Aware of reverse park assist mode, in this mode vehicle will move in reverse when throttle is given.
14. Always park the vehicle on a flat, firm surface, in shaded area and away from flood, fire and other unsafe environments.
15. While charging vehicle always switch on AC supply, only after plugging in both end of the charging cord at there respective positions.

## **Warning**

1. Never attempt to move the vehicle when the steering is locked, you may lose balance.
2. Use appropriate head lamp beam 'high / low' as per the traffic and road conditions for your safety and avoid inconvenience to other riders.
3. Operating the TVS iQube overloaded will hamper riding stability and may lead to loss of control. Hence, it is advisable to carry the recommended amount of load only.
4. Don't touch any open cables or terminals.

## LCD / TFT INSTRUMENT CLUSTER



Unlike conventional scooters this vehicle is having a digital instrument cluster which ensures brighter display and allows ease of interaction between vehicle and customer.

## PLUG IN CHARGING

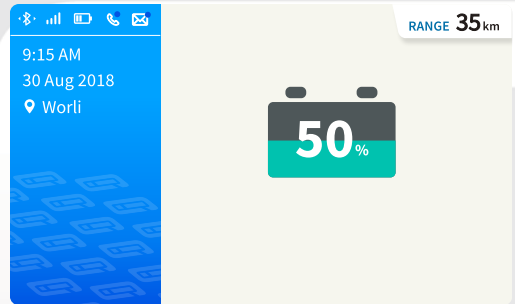

Plug in charging helps user to charge the vehicle battery with the help of included charger.

## PARKING / REVERSE ASSIST

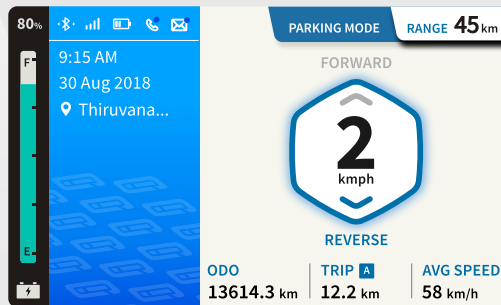

It reduces the effort of parking for customer by allowing controlled movement of the vehicle in forward or reverse direction with minimal speed.

## CUSTOMER SELECTABLE RIDING MODES

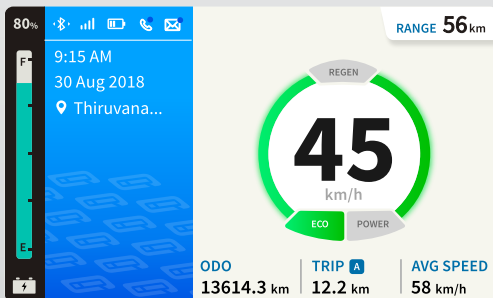

Economy

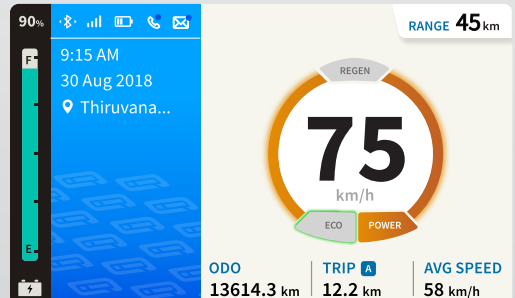

Power



## REGENERATIVE BRAKING

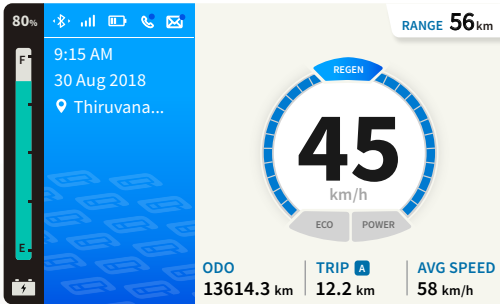

It recuperate energy lost during braking / deceleration of traction motor under specified conditions and charge the battery.

## CALL ALERT

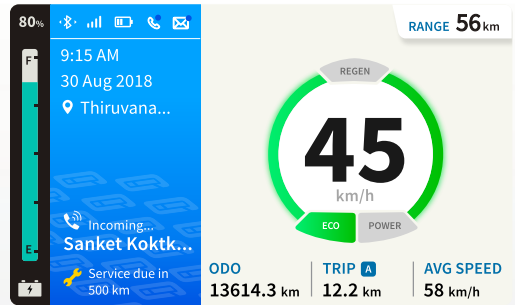

Once Mobile phones connected with vehicle speedometer, incoming call options and messages will be shown in speedometer while customer is riding the vehicle as shown above.

## BLUETOOTH CONNECTED INSTRUMENT CLUSTER, TELEMATICS AND MOBILE APP

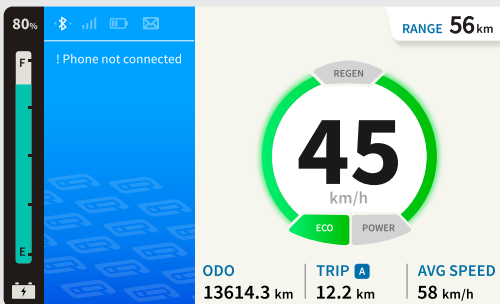

Connect with instrument cluster using mobile app to get access through various features like message notification call accept / reject options etc. on the go.

Telematic unit is used for identifying the vehicle location.

Ride Data Sync (optional) helps customer to know about their ride data and many other functions on the mobile app.

## TURN BY TURN NAVIGATION

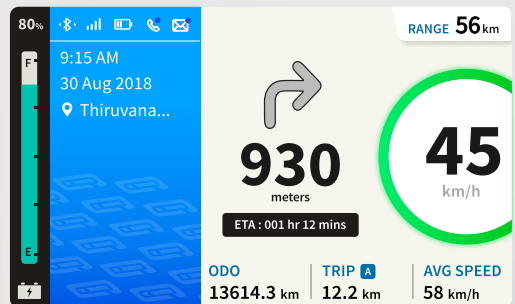

Instrument cluster displays navigation instructions of your desired destination while connected with your smart phone app, just connect and get turn by turn navigation directly on your display.

## BATTERY CHARGE LEVEL & RANGE

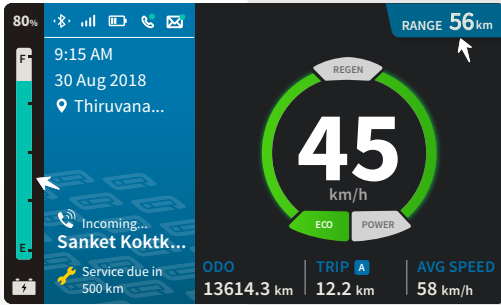

Battery level indication helps customer to know how much battery charge is left in the vehicle by displaying percentage of SOC (Stage of Charge).

Range shows the distance to empty which helps the user to know how much distance can be traveled with the remaining battery charge.

## ILLUMINATING LOGO & UTILITY BOX LIGHT



Illuminating logo displays the vehicle type. Whereas utility box light illuminates the utility box when it is opened.

## ALL LED ILLUMINATION



LED lamps consume less power with increased luminous intensity.

## SIDE STAND INDICATION



Vehicle will be immobile and side stand indication will be shown in the speedometer if the vehicle is on side stand.

### **Caution**

Always release the side stand to its full up position before moving the vehicle.

## MALFUNCTION INDICATION AND SERVICE REMINDER



Malfunction indication notify user to take the vehicle for diagnostic and troubleshooting whereas service reminder recall customer to take the vehicle for periodic maintenance (care) at Authorised Service station based on the alert.

## FLIP KEY WITH LED LIGHT



Foldable key with LED light helps customer to see ignition lock in dark.

## TEXTURED FLOORBOARD



Your scooter comes with a stylish textures floor board.

## PLEASANT HORN TONE

A newly designed horn produces a pleasant tone when pressed by user.





## **CHAPTER A**

Overview ---- (Pages 1 - 8)



## **CHAPTER B**

Vehicle Charging ---- (Page 9 - 10)



## **CHAPTER C**

At a Glance ---- (Pages 11 - 13)



## **CHAPTER D**

Control ---- (Pages 14 - 19)



## **CHAPTER E**

PMS ---- (Page 20 - 22)



## **CHAPTER F**

Warranty Terms & Conditions  
and

Technical specification ---- (Pages 23 - 27)

# OVERVIEW

CHAPTER 1  
CHAPTER 2  
CHAPTER 3  
CHAPTER 4  
CHAPTER 5  
CHAPTER 6  
CHAPTER 7  
CHAPTER 8  
CHAPTER 9  
CHAPTER 10  
CHAPTER 11  
CHAPTER 12  
CHAPTER 13  
CHAPTER 14  
CHAPTER 15  
CHAPTER 16  
CHAPTER 17  
CHAPTER 18  
CHAPTER 19  
CHAPTER 20  
CHAPTER 21  
CHAPTER 22  
CHAPTER 23  
CHAPTER 24  
CHAPTER 25  
CHAPTER 26  
CHAPTER 27  
CHAPTER 28  
CHAPTER 29  
CHAPTER 30  
CHAPTER 31  
CHAPTER 32  
CHAPTER 33  
CHAPTER 34  
CHAPTER 35  
CHAPTER 36  
CHAPTER 37  
CHAPTER 38  
CHAPTER 39  
CHAPTER 40  
CHAPTER 41  
CHAPTER 42  
CHAPTER 43  
CHAPTER 44  
CHAPTER 45  
CHAPTER 46  
CHAPTER 47  
CHAPTER 48  
CHAPTER 49  
CHAPTER 50  
CHAPTER 51  
CHAPTER 52  
CHAPTER 53  
CHAPTER 54  
CHAPTER 55  
CHAPTER 56  
CHAPTER 57  
CHAPTER 58  
CHAPTER 59  
CHAPTER 60  
CHAPTER 61  
CHAPTER 62  
CHAPTER 63  
CHAPTER 64  
CHAPTER 65  
CHAPTER 66  
CHAPTER 67  
CHAPTER 68  
CHAPTER 69  
CHAPTER 70  
CHAPTER 71  
CHAPTER 72  
CHAPTER 73  
CHAPTER 74  
CHAPTER 75  
CHAPTER 76  
CHAPTER 77  
CHAPTER 78  
CHAPTER 79  
CHAPTER 80  
CHAPTER 81  
CHAPTER 82  
CHAPTER 83  
CHAPTER 84  
CHAPTER 85  
CHAPTER 86  
CHAPTER 87  
CHAPTER 88  
CHAPTER 89  
CHAPTER 90  
CHAPTER 91  
CHAPTER 92  
CHAPTER 93  
CHAPTER 94  
CHAPTER 95  
CHAPTER 96  
CHAPTER 97  
CHAPTER 98  
CHAPTER 99  
CHAPTER 100



## VEHICLE IDENTIFICATION NUMBER

The frame and traction motor serial numbers are the only means of identifying your vehicle from others of the same and type. They are also required to assist your Dealer for ordering parts or referring to special information.



The frame serial number is stamped on the frame, at the rear end below the seat assembly. Open the seat assembly and remove the VIN cover to read the frame number.



The traction motor serial number is stamped on the hub of the rear wheel assembly. Rotate the rear wheel assembly to read the frame number.

**Frame number**

**Motor number**

**Control key number**

\*Please fill the above boxes now for future reference

Your TVS iQube is provided with a fully digital connected instrument cluster with lots of feature and modes like **Economy, Power, Parking, navigation assist, Bluetooth connected app for mobile devices**, etc. Moreover your vehicle's instrument cluster is provided with several tell tales & alerts to inform you about the vehicles current condition, lets have a glimpse of them.

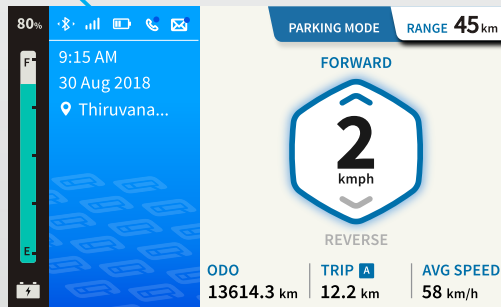
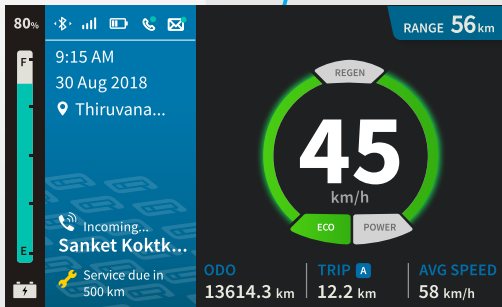
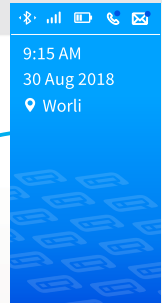
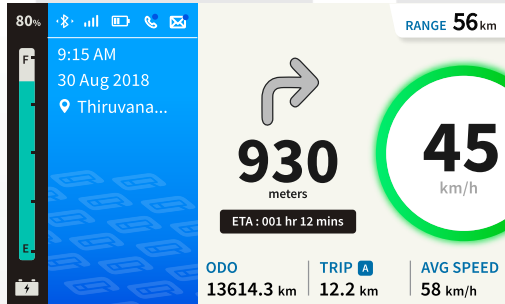

TELL

1. LEFT INDICATOR ON
3. MIL ON

2. HIGH BEAM ON
4. RIGHT INDICATOR ON

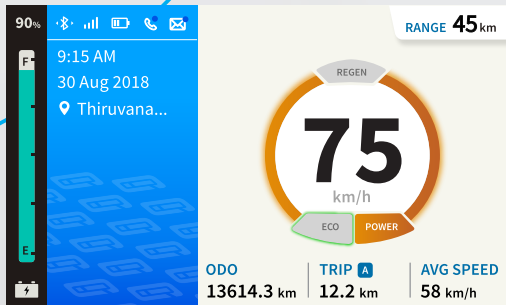
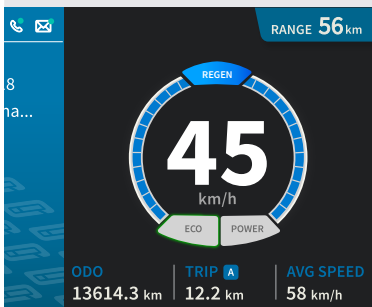
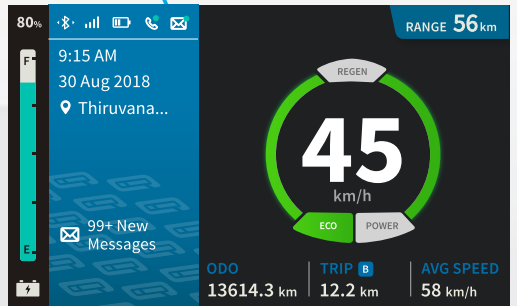
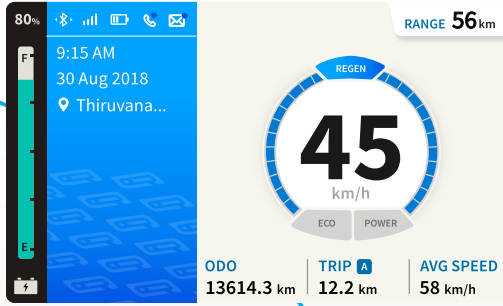

- TALES

5. LOW BATTERY ON



7. SIDE STAND ON

6. PARKING ASSIST ON

8. AMBIENT LIGHT SENSOR

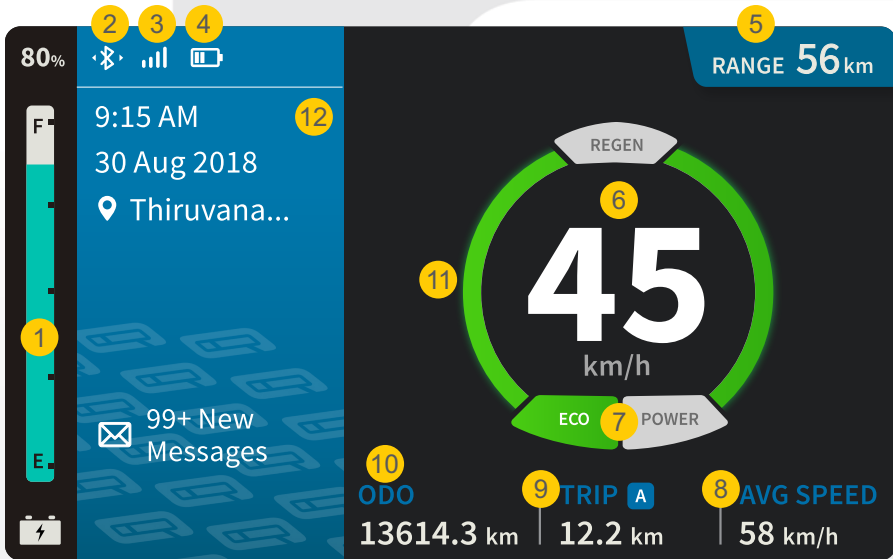
## POWER / ECONOMY MODE DISPLAY



1. Battery level indicator (SOC) - Indicates battery charge in percentage as well as bars;
  - Full SOC – F
  - Low SOC – E (Blinking)
2. Bluetooth ‘’ - Indicates vehicle is connected with rider’s mobile via mobile app.
3. Network signal ‘’ - Indicates mobile signal once connected with vehicle via bluetooth.
4. Mobile battery level indicator ‘’ - Indicates rider’s mobile battery level once connected with vehicle via bluetooth.
5. Range - Shows distance to empty, indicates how more distance the vehicle can go with current level of battery charge.
6. Speedometer - Indicates vehicle current speed.
7. Mode Display - Indicates whether the vehicle in economy or power mode.
8. Average Speed - It indicates average speed in Kmph.
9. Trip A / Trip B - This instrument cluster comes with two trip options Trip A & Trip B to measure to & fro distance between two locations as per the customer requirement. The distance can only be reset using mobile app.
10. Odometer - Shows maximum distance covered by vehicle till now.
11. Power flow indication - Indicates following two condition of vehicle;
  - a. Driving condition: Vehicle is driven by motor by consuming power from the battery.
  - b. Regeneration condition: Indicates regeneration of power is happening.
12. Notification display - Shows current time, date & location.

## DAY / NIGHT MODE

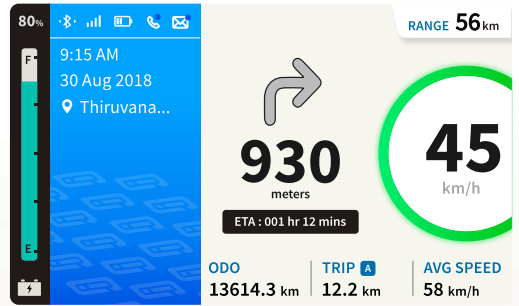

Day / Night mode change over based on the level of ambient light.

## INCOMING CALL AND MESSAGE ALERT

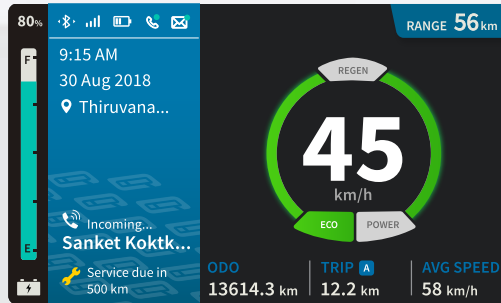

Once Mobile app is connected with vehicle speedometer, incoming Call options and messages will be shown in speedometer while customer is riding the vehicle as shown above.

# SMART XCONNECT

Mobile phones can be connected with vehicle speedometer using Bluetooth, which helps customer to know about their ride data and many other functions. Once Bluetooth connection is established between speedometer and mobile phone, Bluetooth symbol will glow.

Your vehicle also comes with a Telematic unit. This Telematic unit is under the concept of TVS *SMART XCONNECT* and it is equipped with electronics to monitor and transmit various vehicle data such as battery, motor and other electrical systems. The vehicle data allows for various remote function services, some them are following.

- ◆ Remote monitoring of charging status - The charging status of the vehicle can be checked using your internet enabled smart phone (#TVSM APP name) even if you are not near to vehicle.
- ◆ Live tracking – The live status of the vehicle can be checked remotely at any time using TVS mobile app prescribed for this vehicle.
- ◆ Geo-fencing – The telematics system can be set to provide alerts if your vehicle is moved out of a set geographical boundary (can be defined through mobile app).
- ◆ Theft notifications – The telematic system can be used to track unauthorised usage but cannot prevent it. The system will notify the unauthorized movement of a vehicle with live location status. The notifications can be checked on the mobile app.
- ◆ Crash / fall notifications – The safety system helps to detect the fall or crash of a vehicle and will notify the alerts to saved emergency contacts.

Scan QR codes for downloading the mobile app and then follow on screen instructions.



Android



iOS

## PARKING THE VEHICLE

- ◆ User can select Park assistance while parking, by pressing park assist switch (6) & either of the brake switch [(4) / (13)] simultaneously for at least 500 milliseconds.
- ◆ The cluster will enter into **park assist forward mode** as shown, apply throttle to move.

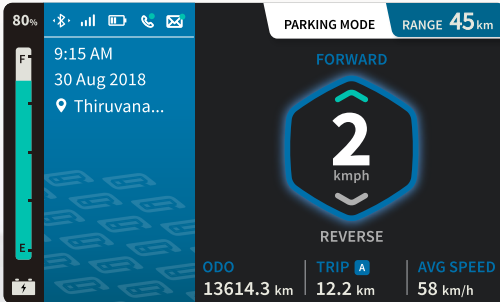

- ◆ Press park assist switch once again, for shifting to reverse mode as shown, apply throttle to move.

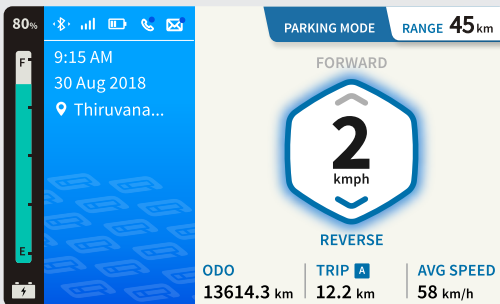

- ◆ During forward movement the speed is limited to 10 km/h and during reverse speed is limited to 3 km/h.

## Note

If ' P ' is glowing in cluster shows that the vehicle is in park assist mode.

## Caution

Park assist switch can be pressed only when vehicle speed is 0 kmph.

## DRIVING THE VEHICLE

- ◆ Switch on the vehicle by turning the key (8) clockwise.



- ◆ After the instrument cluster completes self check while displaying TVSM logo as shown below, it will enter into idle mode ;



- ◆ To activate the vehicle-
- ➔ Press mode switch (6) and either one of the brake [(4) / (13)] simultaneously until you will hear a beep sound once it is activated and it will enter into economy mode-

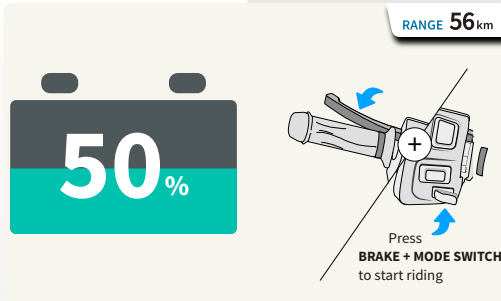

- ➔ Give throttle to start the vehicle in economy mode or press mode switch again to drive in power mode.

## ECONOMY MODE



- ◆ While in power mode, press mode switch (6) to come in economy mode.
- ◆ In this mode the Electric two wheeler is operated with the traction motor and the vehicle speed reaches up to 45 km/h.
- ◆ We can attain more range as compared to power mode.

## POWER MODE

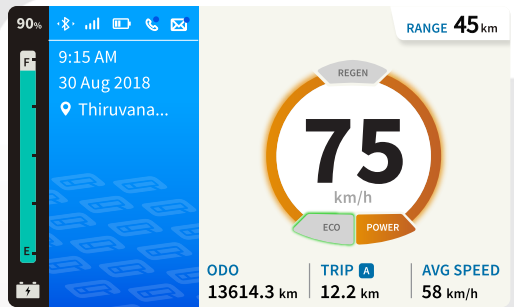

- ◆ While in economy mode, press mode switch (6) to come in power mode.
- ◆ In this mode the Electric two wheeler is operated with the traction motor and the vehicle speed reaches up to 78 km/h.
- ◆ This mode will provide better acceleration than economy mode.

## Note

User can change the mode from economy to power, while vehicle is running by pressing mode switch

## Caution

Don't give throttle and apply brake while vehicle is switching ON.



**VEHICLE CHARGING**



## RCD Integrated Cable\*

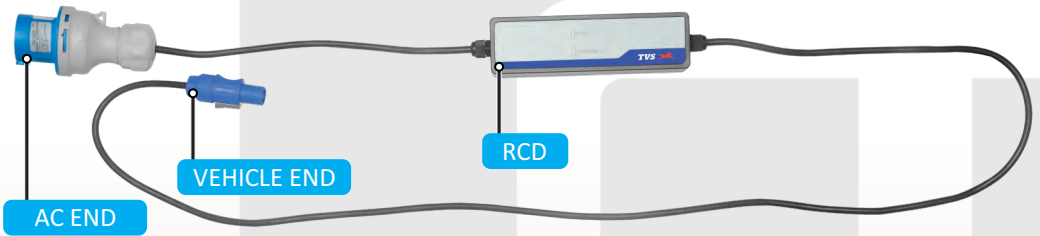

AC end of the charging cable as well as AC socket is of the IEC 60309 standard, industrial plug type for your additional safety.

## CONNECTING FOR CHARGING\*

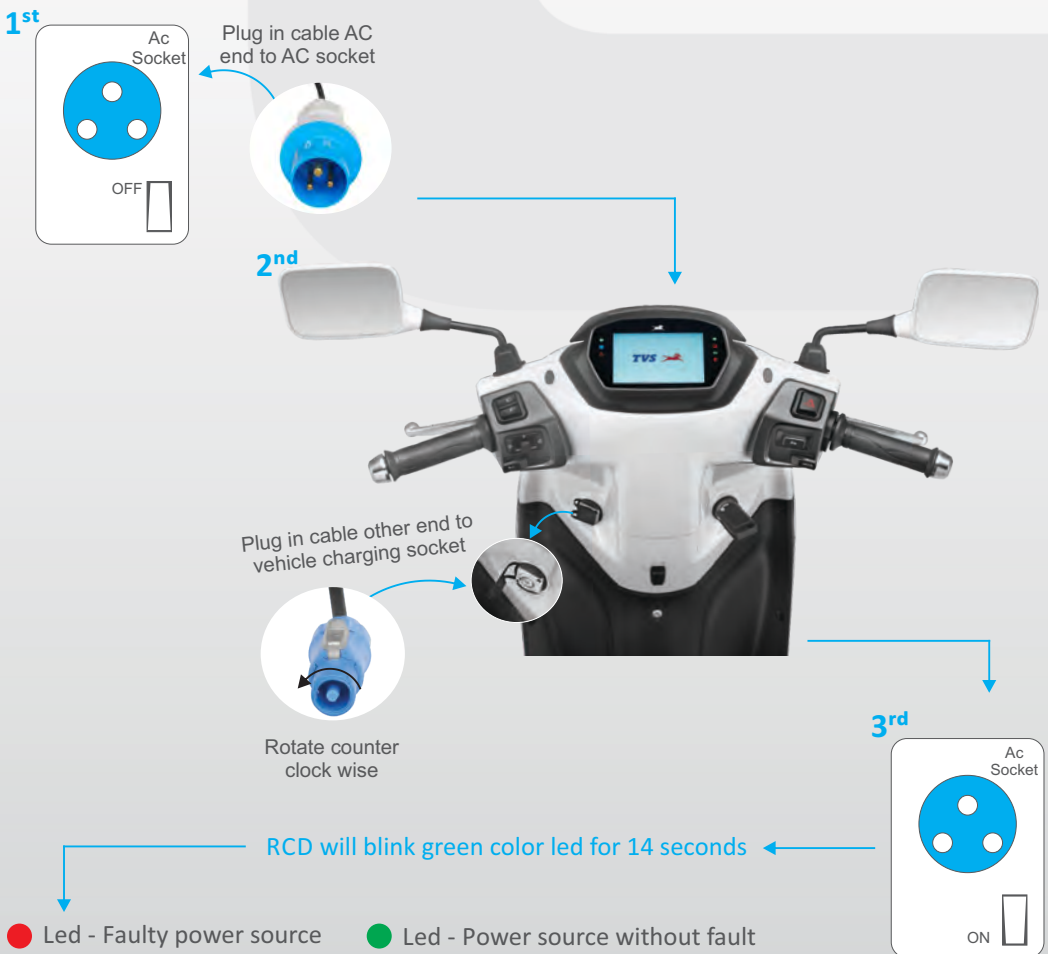

## DISCONNECTING CHARGER

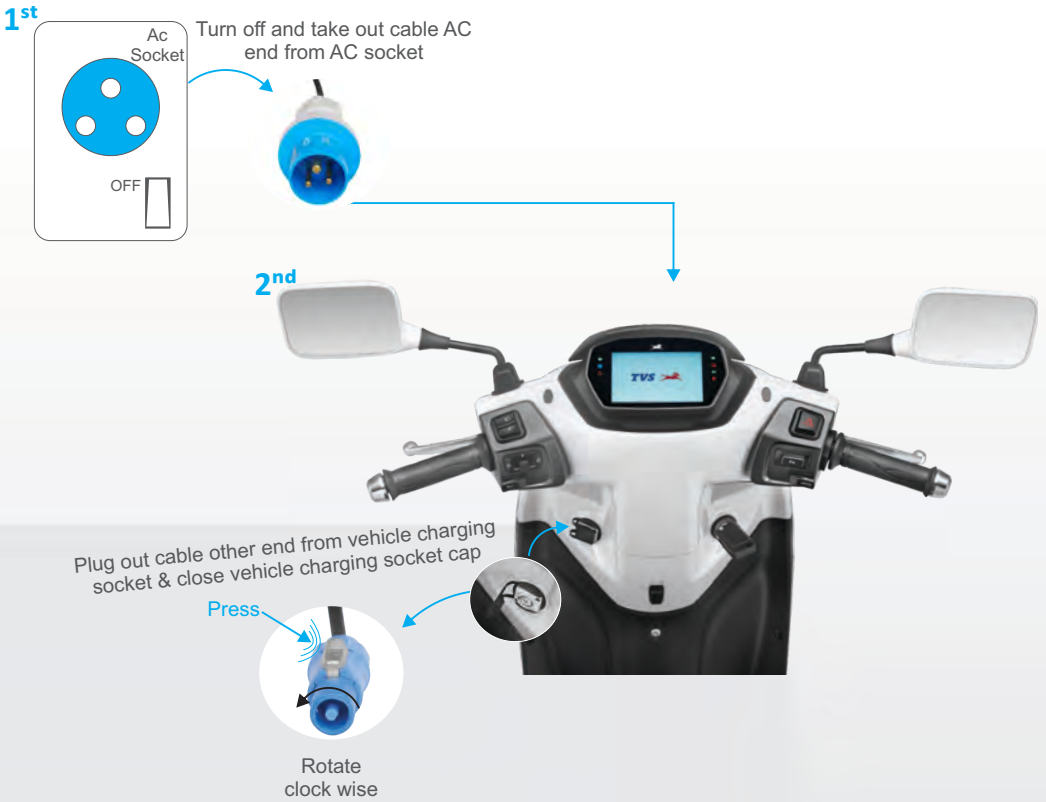

### **i** Note

\* Smart home charging unit and charging cable is an optional accessory.

### **⚠** Caution

Charge the batteries only using provided charger.

Turn on the power supply switch once charger is plugged in the vehicle.

Turn off the power supply switch before disconnecting the charger from vehicle.

During charging vehicle will be immobilized.

# AT A GLANCE



## VEHICLE LEFT SIDE

1. Brake Disc
2. Front wheel axle
3. Side stand
4. Pillion foot rest L
5. Center stand\*



\*Center stand is an optional accessory

## VEHICLE RIGHT SIDE

1. Seat assembly
2. Crash Guard
3. Pillion foot rest R
4. Cover front
5. Bag hook (rear)
6. Front wheel axle nut



## VEHICLE FRONT SIDE

1. Front Position Lamp
2. Turn signal lamp front L
3. Headlamp (AHO)
4. Turn signal lamp front R



## VEHICLE REAR SIDE

1. Tail/ brake lamp
2. Turn signal lamp rear R
3. License plate lamp
4. Turn signal lamp rear L
5. Pillion handle



† Mandatory accessory will be charged extra

## VEHICLE TOP SIDE



1. Instrument cluster
2. Rear view mirror R
3. Hazard switch
4. Right hand brake lever
5. Throttle grip
6. Park assist switch
7. Mode Switch
8. Ignition cum steering lock
9. Bag hook (front)
10. Charging Socket
11. Horn switch
12. Turn signal lamp switch
13. Left hand brake lever
14. Left hand brake lock lever
15. High/low beam switch
16. Rear view mirror L

# CONTROLS





Your TVS iQube comes with a pair of identical control keys. These keys are to operate ignition cum steering lock, fuel tank cap and seat lock.

### IGNITION CUM STEERING LOCK

The ignition switch enables and disables the electrical circuit and steering lock. The three positions of the switch are described below.

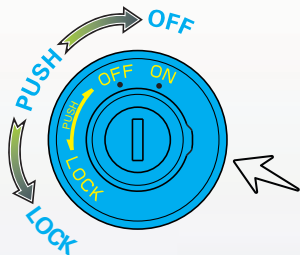

#### 1. 'OFF' position

All electrical circuits are deactivated. The key can be removed from the lock.

#### 2. 'ON' position

All electrical circuits are activated. The connected instrument cluster and warning lights perform the self-diagnostic cycle once upon activation.

The motor can be started. Control key cannot be taken out from the lock.

#### 3. 'LOCK' position

Your TVS iQube steering can be locked in both 'left' and 'right' directions. Turn the handlebar to the 'left' or 'right'. Press the key IN and rotate it to the 'LOCK' position from 'OFF' position.

All electrical circuits are deactivated and the steering is locked. Control key can be removed from the lock.

Insert the key into the lock and press the key IN and turn it to 'OFF' or 'ON' position to unlock the steering.

### **i** Note

Instrument cluster background illumination, front position lamp, illuminating logo, automatic headlamp on (AHO) and tail lamp glow automatically once the ignition key is turned 'ON' without activating any other switches.

When the ignition switch is turned 'ON' the connected instrument cluster performs self-diagnostic cycle. Wait till the IDLE Mode symbol is displayed to proceed with activating the vehicle.

### **!** Caution

Leaving the ignition cum steering lock in 'ON' position for a prolonged time will drain the battery when the vehicle is not in use. Switch OFF and take the key out when the vehicle is not in use.

Always lock the steering while parking for safety.

### **!** Warning

Never attempt to move the vehicle when the steering is locked, you may lose balance.

## HANDLE BAR LEFT SIDE

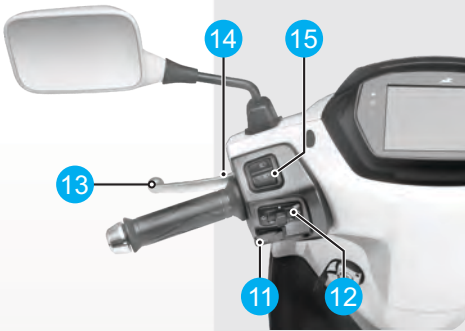

### 11. Horn switch

Press the switch '🔊' to operate the horn.

### 12. Turn signal lamp switch

Slide the turn signal lamp switch to left '←' or right side '→' to operate respective turn signal lamps (LH / RH). Press the center button of the switch to turn 'OFF'.

### 13. Left hand brake lever

The rear brake is applied by squeezing the rear brake lever gently towards the handle grip. The brake lamp glows on application of rear brake .

### 14. Left hand brake lock lever

Left hand brake lock is useful when your scooter is parked with side stand on a slope to avoid falling.

To apply the left hand brake lock, squeeze the left hand brake lock lever fully towards the grip. Hold the brake lever at the same position, press and hold the left hand brake lock lever. Now release the brake lever and ensure that the brake is locked properly.

To release the left hand brake lock, squeeze the left hand brake lock lever further in and the lock will release automatically, release the brake lever upon releasing the brake lock.

## Unlocked

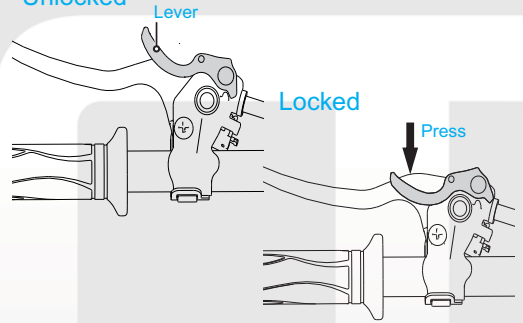

### 15. High/low beam switch

With the head lamp 'ON', press the switch towards '☀️' to operate head lamp high beam or press it towards '☁️' to operate head lamp low beam.

## **i** Note

Ensure that the brake lock lever is released (if applied) before start riding the vehicle.

## **⚠️** Caution

Use appropriate head lamp beam 'high / low' as per the traffic and road conditions for your safety and avoid inconvenience to other riders.

## HANDLE BAR RIGHT SIDE

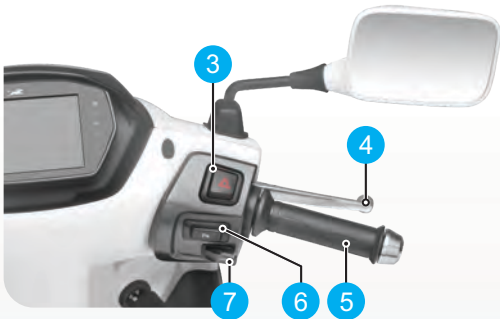

### 3. Hazard Switch

Whenever it is necessary to park iQube in a hazardous location, press the hazard switch in ignition 'ON' condition to start simultaneously flashing of all turn signal lamps as to aware others of your vehicle presence. Press switch to turn-off the lamps.

### 4. Right hand brake lever

The brake lever controls a hydraulic circuit while squeezing and the hydraulic circuit operates the front brake system. The brake lamp glows on application of front brake.

### 5. Throttle grip

Vehicle speed is controlled by the rotation of the throttle grip. Twist it towards you to increase the vehicle speed and twist it away from you or release it to decrease the vehicle speed.

### 6. Park assist switch

Park assist switch activates park assist mode and allows vehicle to roll forward or backward in restricted speed thereby it reduce the effort of parking by customer.

### 7. Mode switch

Mode switch allows to switch between following modes;

1. Economy mode
2. Power mode

## **i** Note

Release the electric starter switch immediately after the motor has started.

## AUTOMATIC HEAD LAMP ON (AHO)



TVS iQube comes with a Automatic Headlamp ON (AHO) LED lamp which glows automatically once the ignition is turned 'ON'.

## EFFORTLESS E-Z CENTRE STAND



TVS iQube is equipped with a effortless (optional accessory) centre stand. The centre stand (a) has a pivoted flexible spring loaded lever arm (stand extension) (b) to increase the lever ratio, which enables parking on centre stand effortlessly and very conveniently.

To place the vehicle on centre stand, hold the handle bar left grip with left hand, place your foot firmly on the centre stand extension (b) while ensuring that both the stand shoes are touching the ground, press the stand extension.

## SIDE STAND



Side stand can be operated by sitting on vehicle with your left foot by pushing it away from the vehicle till it stops.

## **i** Note

Mandatory accessory will be charged extra.

## **!** Caution

Never sit on vehicle when it is supported by stands. Always park the vehicle on a flat, firm surface.

## **!** Warning

Always release the side stand to its full up position before moving the vehicle.

## TOOL KIT AND FIRST AID KIT



To assist you in performing certain aspects of periodic maintenance and emergency repairs, a tool kit is supplied along with the vehicle and it is located below the seat base. To access the tool kit, insert the control key into seat lock and rotate it in clockwise direction. Lift and open the seat.

The tool kit consists one number each of the following. Ensure the contents of the tool kit.

1. 10x12 mm spanner
2. Tool bag
3. Screw driver handle
4. Combination screw driver bit

## Caution

It is recommended to use the tool kit in case of any emergency only. It is always advisable to take your vehicle to TVS Motor Company Authorised Main Dealer / Authorised Dealer.

### UTILITY BOX



Utility box is located below the seat. Lift the seat by unlocking the seat lock as explained in the previous section, to access the utility box. A separate lock (A) is provided inside the utility box. Open this lock using your vehicle key to access front battery pack.

## Caution

- Utility box can be used to carry a load of 10 kg maximum.
- Do not carry perishable items inside the utility box. It is not fully sealed. Do not allow / spray water to get inside the utility box.
- Do not keep heat-sensitive items inside as it may get hot on long rides.
- Do not keep valuable items inside the utility box when leaving the vehicle unattended.

## Warning

Operating the TVS iQube overloaded will hamper riding stability and may lead to loss of control. Hence, it is advisable to carry the recommended amount of load only.

### BAG HOOKS



There are two bag hooks provided with your scooter to carry light luggage like carry bags weighing upto **3 kg**. One hook is located below handle bar on the rear panel.

Just pull out the hook from the top (A) to hang your luggage. Push back the hook once it is free.

Similarly, the other one (B) is located on the cover front below front end of the seat assembly. Pull out the hook from its position. Open the top lid and hang your cargos. Lid will get close automatically. Push back the hook to its original position once it is free.

### SMART PHONE CHARGER

All new smart phone charger has been provided in the utility box of your vehicle. Please follow the guidelines mentioned below for using it properly :

#### Do's

1. Ensure that no water enters into the unit, by closing the USB flap properly.



2. Use the USB, if approved standard USB cable used for charging mobile.
3. Do make sure the flap is not damaged while opening / inserting the USB cable.

#### DON'Ts

1. Do not leave the USB charging flap open / partially closed.
2. Do not attempt to use / charge any other device, other than mobile phones. Only one mobile phone should be charged at a given time.
3. Do not try to force the USB connector in, check whether it is inserted in the appropriate direction, to prevent the damage to the charger.

#### ⚠ Caution

- Care should be taken not to attach the luggage which hangs out of your scooter. Please note that the luggage attached to your scooter should not interfere your feet movement.
- The charging time of the mobile may vary, depending on the mobile's battery state of charge. The rubber flap in the unit has been designed to prevent water entry and is not replaceable. No warranty for charger in case of rubber flap cut.

#### UTILITY BOX LIGHT



Utility box light illuminates the utility box and enhance visibility inside the box when it is opened during the ignition key ON condition.

#### ⚠ Caution

Ensure that the utility box light glass is not damaged while accessing the utilities. Do not slam / forcefully close the seat as it may permanently damage the utility box light switching mechanism.

#### ILLUMINATING LOGO



Illuminating logo will display the vehicle type name as 'ELECTRIC' during the vehicle in zero speed conditions. During charging of the vehicle, illuminating logo will blink. The LED color of the illuminating logo is Blue. Illuminating logo is mounted on the swing arm cover as shown above.

PMS

CHAPTER  
CHAPTER  
CHAPTER  
CHAPTER  
CHAPTER  
CHAPTER  
CHAPTER  
CHAPTER

CHAPTER

## MAINTENANCE SCHEDULE

The maintenance schedule indicates the intervals between periodic services. At the end of each interval, be sure to inspect, check, replace, adjust, lubricate and service as instructed. If the maintenance is not done periodically, it will result in rapid wear and severe damage to the vehicle. If the vehicle is used under high stress conditions such as continuous full throttle operation or is operated in dusty area, certain jobs should be performed more often to ensure reliability of the vehicle. Steering components, suspension and wheel components etc., are key items and require very special and careful servicing.

**TVS Motor Company Limited** strongly recommends that the jobs as per the maintenance schedule be performed by your **TVS Motor Company Authorised Main Dealer**.

Periodic inspections may reveal one or more parts that may need replacement. Whenever replacing parts of TVS iQube, it is recommended that you use only the TVS Motor Company Genuine parts.

### **Caution**

Proper maintenance are mandatory for making certain that your vehicle is reliable and gives optimum performance at all times. Make sure that the periodic maintenance is performed thoroughly in accordance with the instructions given in this owner's manual.



**PAID SERVICE INTERVALS (months or km which ever occurs earlier)**

**LIST OF OPERATIONS**

**SCHEDULE**

SERVICE	1st	2nd	3rd	4th	5th
MONTHS	6	12	24	36	48
km x 1000	4	8	12	16	20

Accelerator cable free play	I, L&A	I, L&A	I, L&A	I, L&A	I, L&A
HBS cable free play	I, L&A	I, L&A	I, L&A	I, L&A	I, L&A
Steering operation	I&A	I&A	I&A	I&A	I&A
Front and rear axle nut tightness	I&A	I&A	I&A	I&A	I&A
Swing arm bolt tightness	I&A	I&A	I&A	I&A	I&A
Center and side stand pivot (optional)	-	C, L&A	-	C, L&A	-
All electrical indication and cluster functions	I	I	I	I	I
Side stand switch mounting bolt tightness	I&A	I&A	I&A	I&A	I&A
Tyre pressure front and rear at cold condition	I&S	I&S	I&S	I&S	I&S
Brake cam and shoe wear rear	I&A	C, L&A	I&A	C, L&A	I&A
Brake rear free play*	I&A	I&A	I&A	I&A	I&A
Brake pad wear	I	I	I	I	I
Brake fluid	I& T	I& T	I& T	I& T	R
Brake hose	I	I	I	I	R
Master cylinder cups	-	-	-	-	R
Charger and charging operation	I	I	I	I	I
Rear wheel noise and smooth rotation	-	I&C	-	I&C	-
Fork oil**	-	-	-	-	-
Controller cable bolt tightness	I& T	I& T	I& T	I& T	I& T

- After 2nd service each service interval will be at 4000 Km or 1 year which ever is earlier.
- **R** - Replace; **I** - Inspect; **T** - Top up; **C** - Clean; **A** - Adjust; **DR** - Drain; **L** - Lubricate; **TI** - Tighten; **S** - Set; **To** - Torque
- Reset service reminder and check for DTC's using diagnostic tool and correct it if any at every service.
- Test drive the vehicle and ascertain smooth functioning of all controls and parts.
- Clean the vehicle before delivery.
- \* Check the rear brake play periodically. However the brake play needs to be adjusted more frequently depending upon the usage.
- \*\*Fork oil has to be replaced at every 24000 km.

## REAR BRAKE (DRUM BRAKE) - SELF MAINTENANCE

1. Measure the free play of the rear brake lever at the lever end as shown in the figure.
2. Free play of brake lever before the engagement of brake should be between 10-15 mm.
3. If the measured distance is more than the limit, adjust the nut provided at the rear wheel end to obtain the correct play.



4. Turn the adjuster nut in clockwise direction for reducing free play or in anti-clockwise direction for increasing the free play.

### **Caution**

Replace the brake shoes as a set, if the wear limit indicator shows beyond the wear limit even after indexing the lever.

# WARRANTY TERMS & CONDITIONS

AND

TECHNICAL SPECIFICATION

CHAPTER

## **TVS Motor Company Limited ('the Company') give this warranty with respect to the TVS iQube manufactured by the Company.**

While the Company has taken every care to maintain quality in the manufacture of the iQube, the above said warranty is subject to other terms of warranty :

During 3 years from the date of purchase or during the first 50,000 km of run for the vehicle, battery, motor, controller and charger in the hands of original retail purchaser, whichever is earlier, the parts of the vehicle covered under warranty which prove to the satisfaction of the Company to have a manufacturing defect will be repaired or replaced free of cost.

The Company's obligation under this warranty is limited to repairing or replacing, free of cost, those parts of the vehicle which upon examination by the Company may prove to the Company's satisfaction to have a manufacturing defect, and in such cases the Company's decision either to repair or replace the affected parts will be final. In the event of replacement of parts, the Company also reserves the right to use parts of the same brand as the affected

parts or any other brand which is used by the Company in the course of manufacture. All parts replaced under this warranty will become the property of the Company and must be returned to the company.

### **Limitations of Warranty :**

This warranty shall not apply to following condition :

1. Any natural wear and tear, including without limitation, aging.
2. Warranty claims on proprietary items such as tyres, tubes etc., should be preferred by the user directly on the respective manufacturer, as per their warranty terms and the Company shall not be liable in any manner in respect to the same.
3. Parts repaired or replaced under this warranty are warranted only throughout the remainder of the original warranty period.
4. The Company is not liable for any delay in servicing due to reasons beyond the control of the Company or any of its Authorised Main Dealers.
5. In any event, the Company is not liable for indirect, remote, incidental or consequential damages.
6. The Company may make any modification or improvement to vehicles in future production at any time without prior notice and without any obligation to install the same on vehicles previously dispatched for sale.
7. Any claim under this warranty will lie only when the customer:
  - takes his vehicle to an Authorised Main Dealer of the Company and reports the problem he / she felt in the vehicle to enable the Authorised Main Dealer to inspect the same and assess the cause for the reported problems.
  - produces to such Authorised Main Dealer the owner's manual for the concerned vehicle for verification of relevant details.
8. This is the only warranty given by the Company for the TVS iQube. No employee, Dealer or other persons authorised to extend or enlarge this warranty.

## Warning

Modifications to this vehicle not approved by the TVS Motor Company may cause loss of performance and render it unsafe for use and disqualifies for warranty coverage also.

### List of parts not covered under warranty

ITEM	WHAT TO CHECK FOR
Normal Maintenance operations	Fastener re-tightening, brakes as well as other normal adjustments.
Wear and tear items	Brake linings, fasteners, shims, washers, etc.
Electrical	Bulbs and fuses.
Service Maintenance Parts	Brake fluid, fork oil etc.
Rubber, rexine & plastic items	All hoses , pipes and plastic aesthetics
Proprietary Items	Tires and tubes (the warranty terms are subject to our agreement with proprietary OEM). <ul style="list-style-type: none"><li>◆ Parts of the vehicle getting affected due to atmospheric effect / environmental factors (rusting, paint peel off etc.). However, depending on the vehicle usage condition, warranty would be accepted up to 2 years from the date of purchase.</li><li>◆ Parts of the vehicle which have been tampered with, altered, repaired or replaced by persons not authorised by the Company and which in the sole judgement of the Company affect the performance of the vehicle.</li><li>◆ Parts which are used in conjunction with parts not made or recommended by the Company.</li></ul>
Others Factors	<ul style="list-style-type: none"><li>◆ Parts suffering damage or resultant damage by accident, misuse, negligent treatment, use of bad quality lubricants or impure fuel or by omission to follow the guidance and instructions contained in this owner's manual.</li><li>◆ Vehicles on which motor number or chassis number is deleted, defaced or altered.</li><li>◆ Vehicles on which any warranty service including scheduled paid service is not availed when it falls due (at TVS Motor Company Authorised Main Dealer / Authorised Dealer).</li><li>◆ Vehicles sold or transferred by original retail purchaser.</li><li>◆ Vehicles used for racing or any competition or used otherwise than for ordinary personal transportation. Vehicles attached with side cars etc.</li><li>◆ Vehicles which have been taken out of India.</li><li>◆ Vehicles affected by natural calamities like flood, earthquake, tsunami, storm etc.</li></ul>

## WARRANTY OF GPS DEVICE

Please note that the warranty on GPS device is offered by the manufacturer of GPS device and the same shall be available independently to the customer who owns this vehicle. All or any defects or issues with the GPS device shall be governed by and subjected to the warranty terms offered by the GPS device manufacturer. TVS Motor Company Limited shall not provide warranty to the GPS device independently and shall not be liable in any manner in respect to the same. In order to facilitate you to avail any warranty support from the GPS device Manufacturer, you may please contact Service department, TVS Motor Company Ltd, Harita, PB No. 4, Hosur-635 109, Tamilnadu. Email: [customercare@tvsmotor.com](mailto:customercare@tvsmotor.com)

Contact information of such manufacturer of GPS device to avail warranty related support or queries shall be provided to you on your request.

Please refer to product website for further details on terms and conditions of the GPS device.

Periodic maintenance always helps good performance of an automobile and our services are planned to keep your TVS iQube performing good. **Please note that carrying out the services for your vehicle at scheduled intervals at any of the TVS Motor Company Authorised Main Dealer / Authorised Dealer is necessary for availing of warranty.** And please also remember that, after the services are over, periodic servicing of your vehicle at appropriate intervals, depending upon its extent of use, will keep your vehicle at its best level of performance.

In case you need any clarification or assistance, please feel free to write to us mentioning the frame serial number, traction motor serial number and date of purchase of your vehicle also the name and place of the Authorised Main Dealer / Authorised Dealer from whom you bought the vehicle and getting it serviced.

### Service Department

**TVS MOTOR COMPANY LIMITED**

**P.O. Box No. 4, Harita, Hosur - 635 109,**

**TAMILNADU, INDIA.**

**Toll free no:- 1800-572-1818**

**MANUFACTURER** : **TVS MOTOR COMPANY LIMITED**  
**P. B. No.4, Harita, Hosur - 635 109, India.**

### POWER TRAIN

Type : Plug in EV  
Battery type : Li-ion  
No. of batteries : 3 Packs  
Rated voltage : 52 V  
Charger specifications : 500 W onboard charger  
Charging time : 80% SOC - 4.5 hrs. (Approx)  
100% SOC - 6 hrs. (Approx)  
Motor type : BLDC  
Motor output power : 3.0 kW (Rated)  
4.4 kW (Peak)\*  
Motor output torque : 140 N.m (Peak)

### CHASSIS

Overall length : 1805 mm  
Overall width : 645 mm  
Overall height : 1140 mm  
Ground clearance : 157 mm  
Wheel base : 1301 mm  
Kerb weight : 118 kg  
Pay load : 130 kg  
Maximum laden weight : 248 kg  
Frame : Duplex tubular frame  
Front suspension : Telescopic hydraulic type  
Rear suspension : Hydraulic Twin tube shock absorber

### TYRE

Tyre size :  
Front : 90/90-12 54J (Tubeless)  
Rear : 90/90-12 54J (Tubeless)  
Tyre pressure :  
Front : 1.69 kg/cm<sup>2</sup> (24 psi)  
Rear (Solo) : 2.25 kg/cm<sup>2</sup> (32 psi)  
Rear (Dual) : 2.54 kg/cm<sup>2</sup> (36 psi)

### BRAKES

Front Drum / Disc : 220 mm dia disc  
Rear : Hand operated internally expanding shoe type,  
130 mm dia drum

### ILLUMINATION & TELL - TALES

Head lamp (High / Low) : 13.5V, 13W / 8.5W LED  
Position lamp : 13.5V, 5.5W LED  
Tail / brake lamp : 13.5V, 0.4W / 2.1W LED  
Turn signal lamp (F/ R) : 13.5V, 2.5W / 1.6W LED  
Number plate lamp : 5V, 2A  
Utilitybox light : 13.5V, 0.2W LED  
Horn : 12V, 2.5A

## INSTRUMENT CLUSTER

Power rating	: 13.5V, 10W TFT
Display	: 800 x 480
Display type	: TFT
Luminous emittance	: 1000 Lux

## FUSES

DC-DC fuse	: 58V, 5A
Charger fuse	: 58V, 10A
Load fuse before Ignition lock	: 32V, 10A
Load fuse after Ignition lock	: 32V, 7.5A

## CAPACITIES

Range per charge (ECO)	: 75 km at full charge**
Range per charge (POW)	: 55 km at full charge**
Front fork oil grade	: Gabriel front fork fluid
Front fork oil capacity	: 91 ± 1 cc
Brake fluid	: TVS (DOT 3 / DOT 4)
Battery capacity	: 2250 W.h (Approx.)**
Top Speed	: Around 78 km/h

## Note

- Specifications are subject to change without notice.
- \* At component level.
- \*\* Real world range may vary with road, load, driving patterns and ageing of battery packs.

## Warning

Using the bulb other than the specified rating can result in overloading of the electrical system or premature failure of the bulb.







**TVS MOTOR COMPANY LIMITED**

P. B. No. 4, Harita, Hosur - 635 109, Tamil Nadu, India.  
Tel: +91 (4344) 276780. Fax: +91 (4344) 277311/276878.

[www.tvsmotor.com](http://www.tvsmotor.com).