

# **TVS KING** **KARGO**

**225** **LIQUID**  
**COOLED**

(Liquid cooled 4 Stroke Petrol)

## CUSTOMER DATA

NAME : .....

Address : .....

.....

.....

PIN Code : ..... Mobile No : .....

Tel. No : ..... Alt. Mobile No : .....

Booklet No : ..... Date of sale : .....

Vehicle Chassis No : ..... Engine No : .....

Dear customer,

We at TVS Motor Company congratulate you for choosing TVS King Kargo. We wish you many miles of enjoyable riding and better earnings in the years ahead.

TVS King Kargo is manufactured at the world class manufacturing facility of TVS Motor Company with best quality of material and workmanship .We hope it will fulfill your dreams and ambitions.

This booklet is your guide to maintain and operate your TVS King Kargo. So please read and follow the manual carefully to enjoy years of pleasurable riding and increased earnings. As with any good machine, proper care and maintenance is essential for trouble free operation and optimum performance of your vehicle.

## **FOREWORD**

Our dealerships are well equipped with the required diagnostic equipments and a dedicated company trained service team for professional care of your vehicle so that you can be rest assured of our support in the unlikely event of any trouble with the vehicle's performance. Hence we urge you to get your vehicle serviced only at Authorized TVS Motor Company Distributor or Dealers / Authorized Service Centers.

For any problem or further clarification, you can contact our Help Line Number or write to TVS Motor Company quoting your Engine. No & Chassis .no .

You are requested to fill the user information coupon provided in this booklet.

Wishing you pleasant riding and increased earnings for years to come.

With warm regards,  
TVS Motor Company.

All information illustrations, photographs and specifications contained in this owner's manual are based on the latest product information available at the time of this publication. TVS Motor Company limited may however; incorporate modifications or improvements on its vehicles at any time without notice and therefore, in such events it is possible that the relevant part of the owner's manual does not apply to your vehicle.

Prior permission of TVS Motor Company Limited is required for quoting, copying or reproducing any part of this owner's manual.

## **NOTICE**

### NOTE

Pictures illustrated in this manual are of TVS King Kargo GK LT / GK PF / GK DAC

Accessories shown in the picture may not be part of the standard equipment.

### ACCESSORIES DETAILS

Sl. No.	DESCRIPTION	QUANTITY
1.	Tool kit	1 Set 6 tools
2.	Spare Wheel	1 Number
3.	Keys	2 Numbers

In case of critical problems during the course of product usage, servicing or any technical assistance you may contact us at

TVS MOTOR COMPANY **TVS** 

TVS Motor Company Limited. P.B. No.4, Harita, Hosur - 635 109

Tamil Nadu, India. Tel: +91(4344) 276780.



Website: [www.tvsmotor.com/ib/home](http://www.tvsmotor.com/ib/home)

Safety of yours and others are very important while operating this vehicle .

To help you make informed decision about safety, we have provided operating procedure and other information on labels in this manual. This information alerts you on potential hazards that could hurt you , others and goods.

We are providing the following safety labels and safety messages in the manual

## SAFETY INFORMATION

-  **WARNING** Disregarding this message might result in injury to the driver ,customer and to the goods .
-  **CAUTION** This message indicates special procedure or precaution to be followed to avoid damages to the vehicle
-  **NOTE** This message provides further clarification for better understanding of any particular information

<b>CONTENTS</b>	<b>Description</b>	<b>Page.No.</b>
	Useful Information	06
	Vehicle Identification Number	07
	Know Your Vehicle	07
	Features in Your Vehicle	15
	Safe Riding Tips	34
	Operating Your Vehicle	35
	Periodic Maintenance Schedule	38
	Recommended Lubricants	42
	Self-Maintenance Procedures	43
	Service Record Sheet	60
	Technical Specifications	61

## USEFUL INFORMATION

- Periodic maintenance helps good performance of an automobile and our services are planned to keep your vehicle performing good.
- Carry out the proper services at specified intervals.
- Always use choke for cold starting when the vehicle is running in petrol.
- Use clutch only while shifting gears. Do not engage and dis-engage the clutch suddenly.
- Do not run the vehicle at full throttle for long periods and in stationary condition.
- Check and top up engine oil, coolant if required and replace the differential and engine oil as recommended.
- Always use recommended grade of lubricants, coolants and Genuine TVS Motor spare parts.
- Maintain recommended tyre pressure and rotate tyres as recommended.
- Reduce the speed while taking sharp turns. Do not apply the brakes while turning.
- Don't overload the vehicle. Recommended to fill the fuel early morning.

### Running-in information.

The first 2000 km is a crucial part of TVS King Kargo. Proper running-in operation during this period helps in ensuring a longer life and smooth performance of your vehicle. During running-in period do not exceed following speed limits .

Km.	1st gear	2nd gear	3rd gear	4th gear
0 - 750	10 km/h	15 km/h	25 km/h	40 km/h

Always keep within specified speed limit

Do not operate the engine in a manner that could expose the engine to excessive stress.



**VEHICLE IDENTIFICATION NUMBER**

The frame and engine serial numbers are the only means of identifying your vehicle from others of the same model and type. They are also required to assist your Distributor or Dealers for ordering parts or referring to special information .

**Know your  
vehicle**

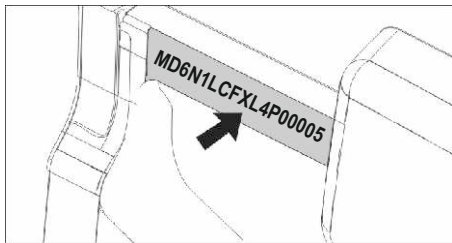

Chassis number can be located on the right side of 'B' pillar partition on the driver side as shown in the above figure.

Chassis number

--	--	--	--	--	--	--	--	--	--	--	--	--	--	--	--	--	--	--	--

Engine number

--	--	--	--	--	--	--	--	--	--	--	--	--	--	--

Control key number

--	--	--	--	--	--	--	--	--	--	--	--	--	--	--	--	--	--	--	--

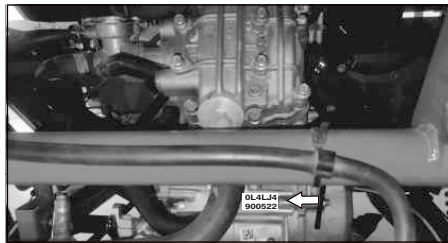

Engine number can be located on crank case RH near the rear mounting as shown in the above figure.

**VEHICLE LH**

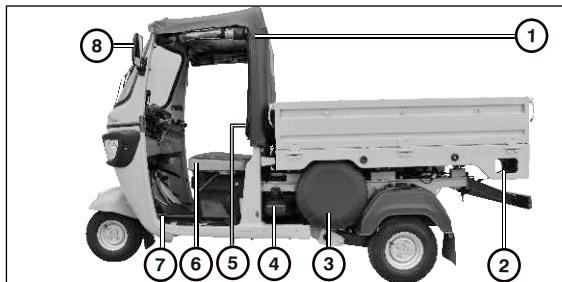

**VEHICLE - RH**

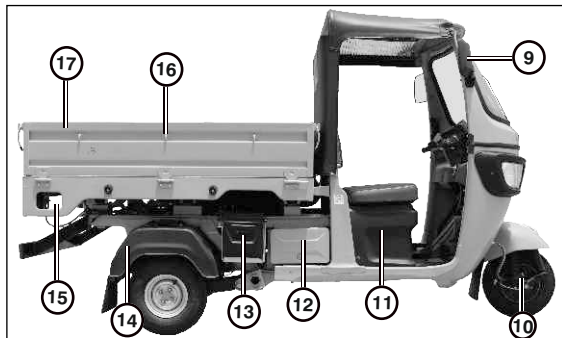

\* Accessories shown may not be a part of standard equipment

**VEHICLE - LH (LT - Load Tray)\***

1. Soft top assembly
2. Load tray Integrated Foot Step
3. Spare wheel with cover
4. Petrol Tank
5. Driver back rest
6. Driver seat
7. Hand starter lever
8. Mirror assembly LH

**VEHICLE - RH (LT - Load Tray)\***

9. Mirror assembly RH
10. Speedo hub
11. Cover petrol
12. Utility box - 50 Ltr
13. Battery with cover
14. Mud guard
15. Load tray Integrated foot step
16. Rope hook
17. Load body complete assembly

**\* Please select respective model**

**VEHICLE LH**

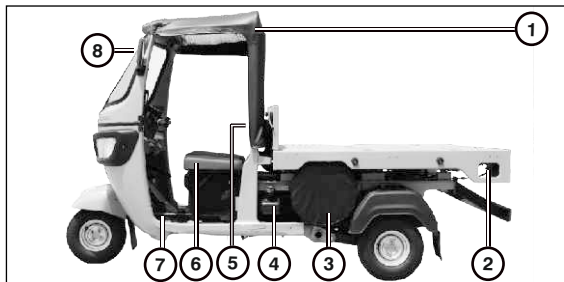

**VEHICLE - LH (PF - Plat Form)\*\***

1. Soft top assembly
2. Load tray Integrated Foot Step
3. Spare wheel with cover
4. Petrol Tank
5. Driver back rest
6. Driver seat
7. Hand starter lever
8. Mirror assembly LH

**VEHICLE - RH**

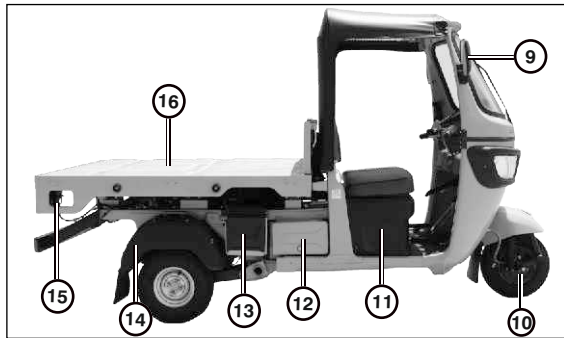

**VEHICLE - RH (PF - Plat Form)\*\***

9. Mirror assembly RH
10. Speedo hub
11. Cover petrol
12. Utility box - 50 Ltr
13. Battery with cover
14. Mud guard
15. Load tray Integrated foot step
16. Load body complete

\* Accessories shown may not be a part of standard equipment

**\*\* Please select respective model**

**VEHICLE LH**

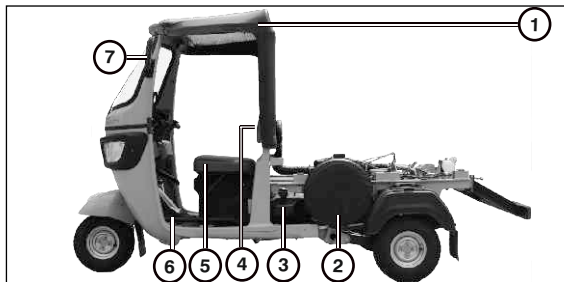

**VEHICLE - LH (DAC - Drive Away Chassis)<sup>#</sup>**

1. Soft top assembly
2. Spare wheel with cover
3. Petrol Tank
4. Driver back rest
5. Driver seat
6. Hand starter lever
7. Mirror assembly LH

**VEHICLE - RH**

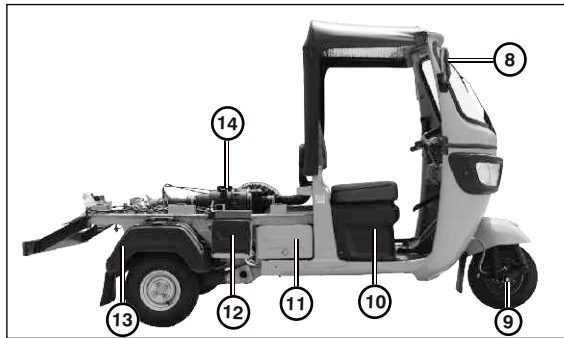

**VEHICLE - RH (DAC - Drive Away Chassis)<sup>#</sup>**

8. Mirror assembly RH
9. Speedo hub
10. Cover petrol
11. Utility box - 50 Ltr
12. Battery with cover
13. Mud guard
14. Air cleaner assembly

\* Accessories shown may not be a part of standard equipment

<sup>#</sup> **Please select respective model**

**FRONT VIEW**

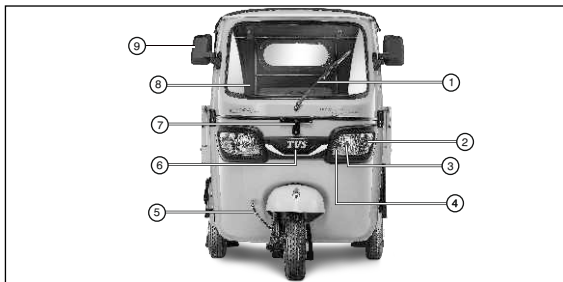

**FRONT VIEW**

1. Wiper blade
2. Turn signal lamp
3. Head lamp
4. Position lamp
5. Front brake fluid hose
6. Logo grill
7. Number plate bracket front
8. Wind shield glass
9. Rear view mirror

**REAR VIEW**

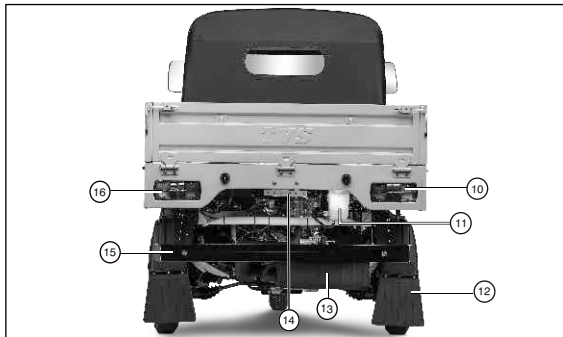

**REAR VIEW**

10. Flushed type Rear Combination Lamp RH
11. Coolant reservoir
12. Mud flap
13. Muffler assembly
14. Rear number plate bracket
15. Chassis mounted adjustable bumper
16. Flushed type Rear Combination Lamp LH

\* Accessories shown may not be a part of standard equipment

**CONTROL PANEL**

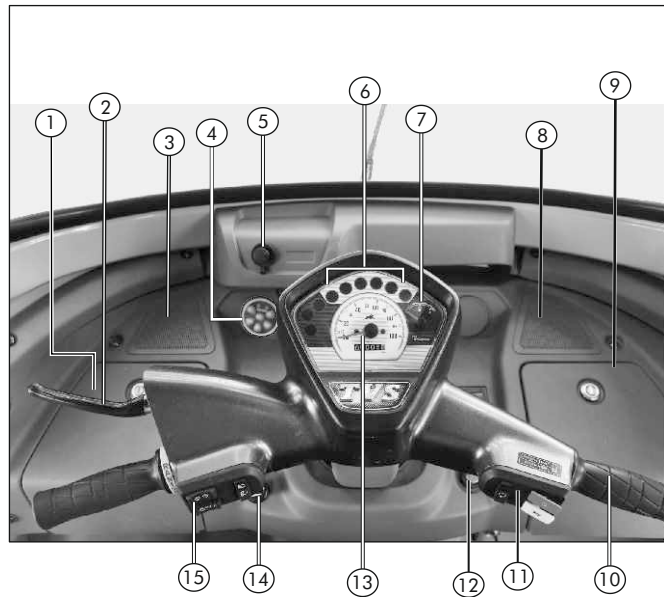

**CONTROL PANEL**

1. Glove box LH
2. Clutch operating lever
3. Speaker grill LH
4. Music switch cluster
5. Mobile charger unit
6. Cluster assembly tell tale lamp
7. Fuel level gauge
8. Speaker grill RH
9. Glove box RH
10. Throttle grip
11. Control switch assembly RH
12. Ignition switch
13. Speedometer
14. Petrol choke knob
15. Control switch assembly LH

\* Accessories shown may not be a part of standard equipment

**DRIVER CABIN - RH**

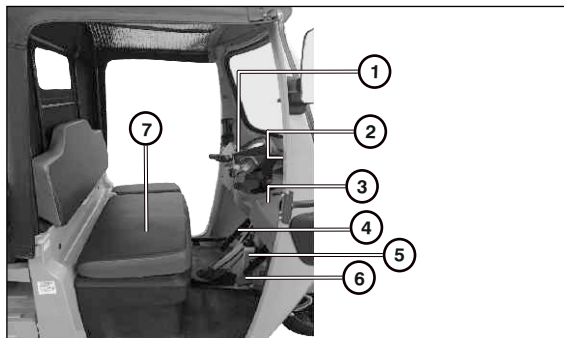

**DRIVER CABIN - RH**

1. Handle bar
2. Wiper motor
3. Dash board
4. Hand brake control lever
5. Master cylinder assembly
6. Brake pedal
7. Driver seat

**CONTROL SWITCHES - LH**

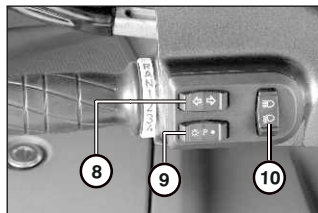

**CONTROL SWITCHES - RH**

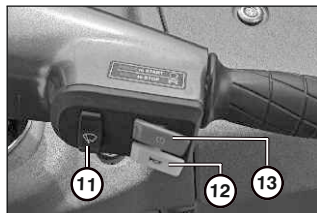

**CONTROL SWITCHES - LH**

8. Turn signal lamp switch
9. Head lamp ON / PARK / OFF switch
10. Head lamp High / Low beam switch

**CONTROL SWITCHES - RH**

11. Wiper switch
12. Horn switch
13. Single Start Stop Switch

\* Accessories shown may not be a part of standard equipment

**LOAD Body**

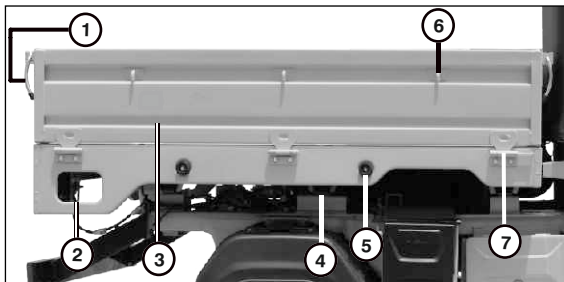

**Load Body**

1. Load body side door latch lever Rear RH
2. Integrated load body foot step
3. 3 Side openable doors
4. Load body mounting - 6 nos.
5. Load body door stopper
6. Rope hook
7. Side door hinges

**ENGINE COMPARTMENT TOP VIEW**

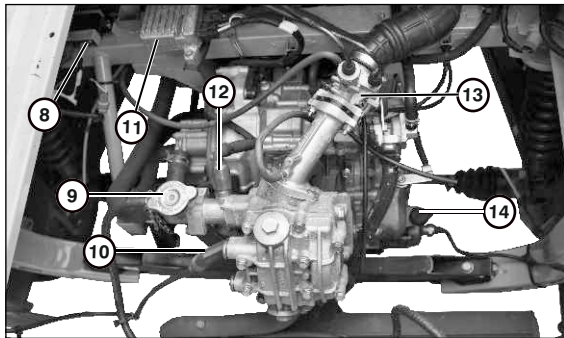

**ENGINE COMPARTMENT TOP VIEW**

8. TCI Unit
9. Cap radiator
10. Suppressor cap
11. ISG Control unit
12. Temperature sensor engine
13. Carburettor assembly
14. Gauge oil level

\* Accessories shown may not be a part of standard equipment



Here you can familiarize yourself with operation of features provided in your vehicle.

1. Control Key operations
2. Safety Features
3. Operating Features

Accessories provided with the vehicle

1. Tool Kit
2. Owner's Manual
3. Chassis Mounted Bumper
4. Idol Stand Kit
5. Driver Cabin Lamp
6. Magazine Holder
7. Water Bottle Holder
8. Head Tube Cover
9. Brake Pedal Foot Rest
10. Spare wheel with cover
11. Battery cover
12. Engine cabin lamp
13. Rain cover
14. Screw Jack & Lever
15. Canvas soft top

## **FEATURES IN YOUR VEHICLE**

## Control key operations



### Ignition switch

TVS King Kargo comes with a set of two control keys.

This key is used to operate ignition switch, steering lock, glove box and fuel lid.

#### 1. Ignition switch

The ignition switch has two positions.

**OFF:** All electrical circuits are turned OFF in this position. Key can be taken out in this position

**ON:** In this position the engine can be started. Horn, turn signal wiper motor and tell tale lamp, can be operated. Key cannot be taken out in this position

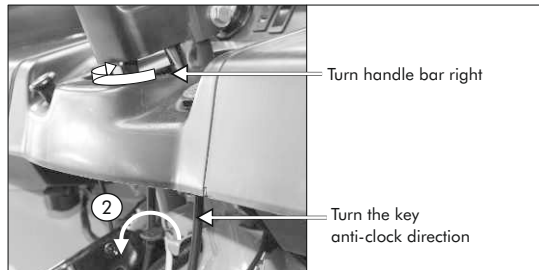

#### 2. Steering lock.

To protect your vehicle from theft, steering lock is provided in your TVS King Kargo. It is positioned on the steering column, below the dash board.

To lock the steering,

- Turn the handle bar to extreme right.
- Turn the key in anti-clock direction
- Take out the key

\* Accessories shown may not be a part of standard equipment

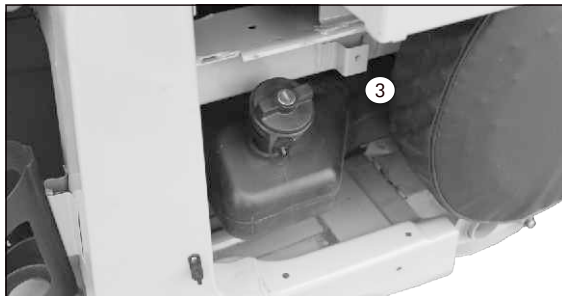

### 3. Fuel tank cap with locking system

Fuel tank cap is provided on the LH side of the vehicle.

To fill the fuel open the fuel tank cap by inserting key and turn it in anti-clock wise direction and pull outwards.

Key cannot be taken out in this position.

Open the petrol tank cap to fill the fuel.

To lock the lid close the lid and turn the key in clock wise direction

**CAUTION**

Use only unleaded petrol. Do not mix 2T oil with petrol.

\* Accessories shown may not be a part of standard equipment

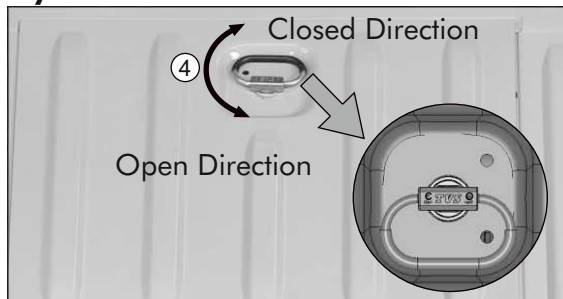

### 4. Service door

To open the Service door a latch lever is provided on the service door. Turn it in anti-clock wise direction to open the Service door. Direction is engraved in the handle

To lock the service door, place the service door correctly, and turn the latch lever in clock wise direction. Refer the direction embossed on the Latch lever.



### 5. Glove boxes

It is provided on the left hand side and right hand side of the dash board. We can store up to 2.9 liters (Aprox) in each glove box.

To open the glove box turn the key anti clockwise. Key cannot be taken out in this position. To lock the utility box close the lid, turn the key in clock wise direction and take out key.

### Safety features

These features are provided to assist you in safe driving.



Do not keep any valuable things & documents inside glove box

\* Accessories shown may not be a part of standard equipment

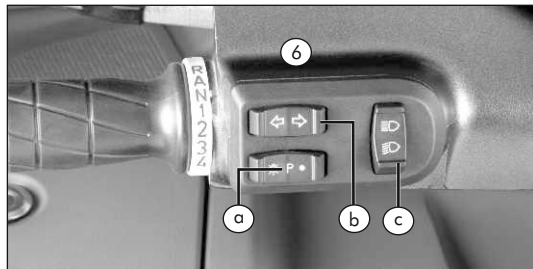

### 6. Switch assembly LH

It is positioned on Handlebar LH

#### a) Head Lamp Switch



It has three positions explained as follows

● : Head lamp, position lamps, speedometer lamp, tail lamp and number plate lamp will not glow with switch in this position though ignition switch may be in 'ON' position. and engine is in running condition.

P : Position Lamp, tail lamp and speedometer lamp and number plate lamp will glow when switch is in this position with ignition switch in 'ON' though engine is not running.

TVS King Kargo comes with DC headlamp. In this switch position, '  ' head lamp also will glow along with speedometer lamps, tail lamps, number plate lamp and position lamp irrespective of Engine ON / Off condition.

**b) Turn signal lamp switch (Left & Right)**

On pushing the turn signal switch in left or right '   ' the respective indicator lamps will glow in both front and rear. It gives an indication in which direction you are turning.



To turn off turn signal lamp bring the switch to central position.

**▲ WARNING**

Always use the appropriate turn signal lamps when you take a turn.

Switch off turn signal lamp after negotiating turn.

**c) Head Lamp high/low beam switch**

Press the knob towards '  ' to operate in high beam of the headlamp and towards '  ' to operate in low beam.

**▲ WARNING**

Use appropriate beam (High / Low) as per the traffic and road condition for safety and comfortable riding.

**7. Switch assembly RH**

It is located on the handlebar RH

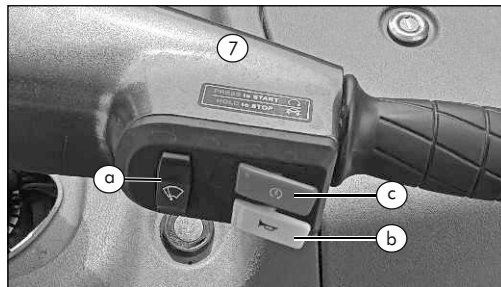

**a) Wiper motor Switch**

It has two positions

**ON** : Wiper motor operates in this position.

**OFF** : Wiper motor stops operating in this position.

**▲ CAUTION**

Do not operate the wiper motor on the dry wind shield glass. During washing please ensure that the wiper motor is wrapped with polythene sheet to prevent water entry.

\* Accessories shown may not be a part of standard equipment

## Features in your vehicle

### b) Horn Switch:

Press the button  provided on the RH switch assembly to operate the horn.

### c) SSS : Single Start Stop Switch

It is used to switch off the engine by giving long press (3 seconds), also to keep other DC system active. The ignition circuit is disabled, preventing the engine from being restarted. To restart the engine, again short Press the switch.



### 8. Hazard switch

Press this switch  to operate warning lamps in case of vehicle breakdown on road for repair or emergency. This switch can be operated even when ignition is in OFF position.

### 9. Wiper motor.

It is located on the wind shield frame above dash board.

### 10. Mobile charger

Your TVS King Kargo comes with smart USB type mobile charger on idol stand as shown in the below fig.



**Wiper motor & Mobile charger**

### Parking brake lever

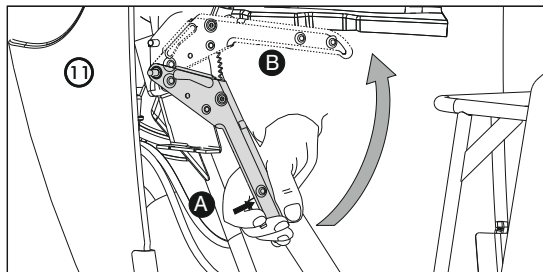

#### 11. Parking brake lever.

It is provided below the dash board. Use the parking brake while parking the vehicle especially on gradient to prevent vehicle rolling.

Press the lock button ' A ' and pull the lever ' B ' upward to apply the brake. To release brake again press the lock button and push the lever downwards.

**⚠ WARNING**

Ensure that hand brake is released before driving the vehicle

### Speedometer and Odometer

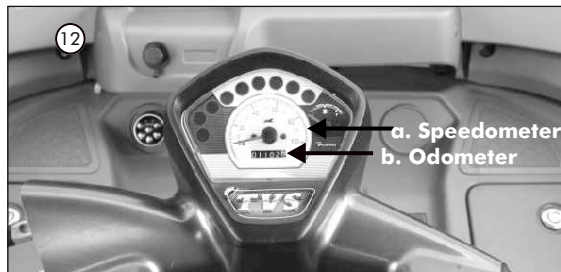

#### 12. Speedometer & Odometer

##### a. Speedometer

Indicates the vehicle on- road speed in kilometer per hour.

##### b. Odometer

It registers the total distance covered by the vehicle.

**📌 NOTE**

Check kilometer readings carefully to service your vehicle at the recommended kilometers mentioned in service coupons.





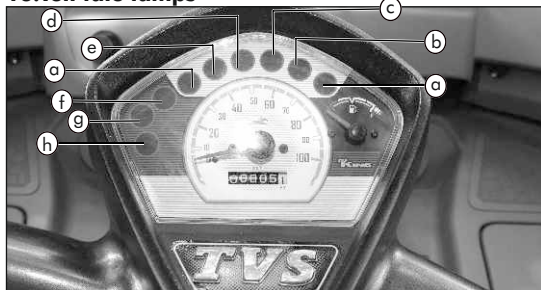



## Features in your vehicle

### 13. Tell tale lamps



### 13. Tell tale lamps

- a. Turn signal indicator lamps
- b. High temperature warning lamp
- c. Neutral indicator lamp
- d. High beam indicator lamp
- e. Engine oil pressure indicator
- f. Malfunction indicator lamp ( not applicable )
- g. Charging & Low battery voltage indicator
- h. Low brake oil warning lamp (not applicable)

Symbols	Description	Glow Indication	Action to be taken	Colour
	Turn signal indicator lamp	Left or right indicator is in 'ON'	Switch off after taking turn	Green
	Neutral indicator lamp	Vehicle is in neutral gear condition	Safe to start the engine	Green
	High beam indicator lamp	Head lamp high beam is in 'ON'	An indication signal	Blue
	Engine oil pressure indicator	Low engine oil pressure	Take the vehicle to dealer	Red
	High temp warning lamp	Indicates high coolant temperature	Check Coolant level / Report to nearest Authorised Service Center	Red
	Charging & Low Battery Voltage Indicator	Improper Charging or Low battery Voltage	Report to nearest Authorised Distributor or Dealer or Service Center	Red
	Malfunction Indicator lamp	NA	NA	NA
	Low Brake oil Warning lamp	NA	NA	NA



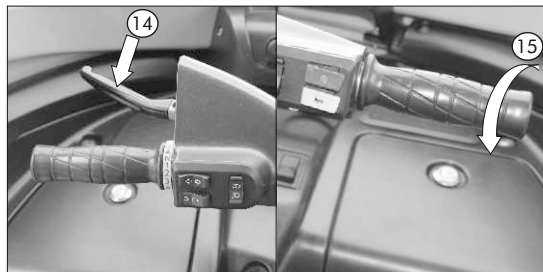

**Clutch lever & Tube complete throttle.**

**14. Clutch lever.**

Use the clutch lever to disengage/engage the drive, from the engine to transmission while shifting gears. Depress the lever towards your side to dis-engage and release the lever to engage the clutch

 **CAUTION**

Always use clutch lever while changing gears to ensure smoother gear shifting

**15. Tube complete throttle**

Engine rpm is controlled by the position of the throttle grip. Rotate it in anti-clockwise to increase the engine rpm. Rotate it clockwise or release it to decrease the engine speed.

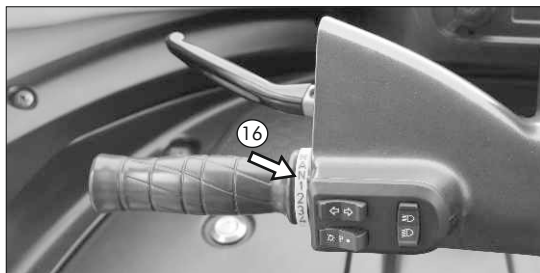

**Tube complete gear shift**

**16. Tube complete gear shift**

To shift gears depress the clutch lever and rotate the gear shift twist grip downwards to engage forward and upwards to engage the reverse gear.

In between the neutral 'N' and reverse 'R' there is an alert 'A' position

**17. Petrol Choke**

Use the petrol choke lever when vehicle is starting in petrol mode, pull the lever up -wards to operate the choke

**CAUTION**

Remember to release the choke in petrol mode after starting.

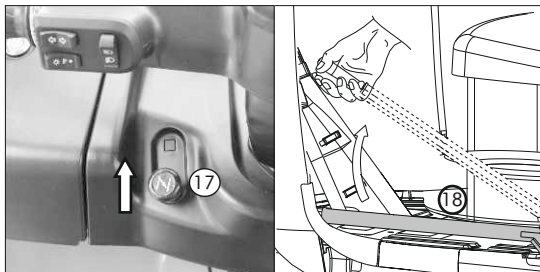

**Hand starter lever & choke knob**

**18. Hand starter lever**

Pull the hand starter lever upward to start engine

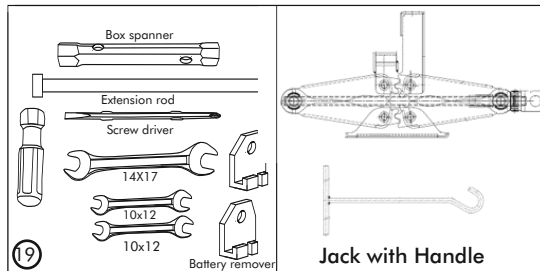

**Tool kit and Screw jack with handle**

**19. Tool Kit & Screw Jack with Handle**

Tool kit is located in the lockable glove box on the right hand side of the dashboard. Jack with handle is located in the RH side Lockable Utility Box.

**CAUTION**

Always follow the procedures given in self maintenance section while using tools provided in the tool kit & Jack  
Please bring your vehicle to the Authorized distributor or dealer / Authorized service center in case of any major repairs.

\* Accessories shown may not be a part of standard equipment



**Utility Box**

**20. Utility box**

Utility box is fitted in RH side of the vehicle. It is provided with locking system. you can store up to 50Lit capacity. Vehicle Jack is placed inside this utility box.

To open the Utility box, first turn the key anti clockwise direction. Pul out the lid utility box. Key cannot be taken out in this position. To lock the utility box close the lid, turn the key in clock wise direction and take out key.

 **CAUTION**

Utility box provided is not a water proof. Do not keep any important documents inside.

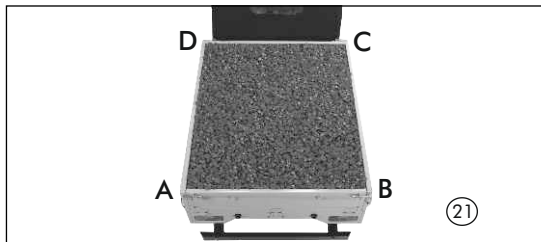

**Load Body**

**21. Load body**

Your TVS King Kargo GK LT variant comes with load deck. You can carry the goods as per the recommended load carrying capacity. Size of the load deck is Length 1500mm, Width 1300mm, Height 280mm. It is provided with 3 sides openable side doors ( LH , RH & Rear). To open the side door gently pull out the latches(A,B,C,D) from its lock & move to and fro direction. Engine service door is also provided on the Load deck. Refer Procedure opening of service door for opening & closing Page no.17

**INTEGRATED MUSIC SYSTEM**

TVS KARGO brings you most exciting distinct feature of "Music System" in its all models which accompany you all the way, gives you a joyful ride and always ensures your every trip is entertained. Factory fitted USB drive allows you to enjoy your favorite music. Set of Speakers not only gives you a pleasant journey but also entertains your passenger. Stay tuned to FM channels with TVS KARGO FM stereo system.

**Description**

1. Speaker LH
2. Speaker RH
3. Switch cluster
4. USB port
5. Aux Port

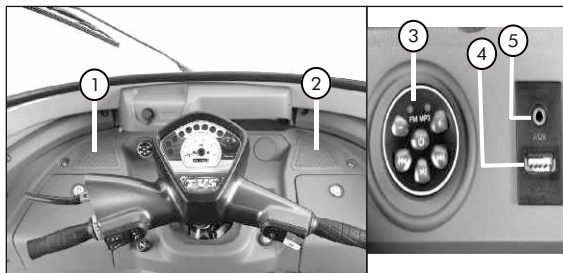

**Features in your vehicle**

Music player	: Automotive qualified music player capable of playing from common flash drives in MP3 format and FM radio.
Power wattage	: 10 +10 Watts Stereo Amplifier - Class AB
Dimensions of Music Player	: 76mm x 120mm x 31.5mm
Weight of Music Player	: 196 grams
Operating Temperature	: 0 - 80° C
Recommended usefully charged battery	: Maximum 2 hours continuous run on vehicle with 'ON' stand condition (from fully charged battery)
Auto battery Cutoff	: Music player discontinues it self when battery voltage is less than 8.5 V DC in order to save power for subsequent normal operation of vehicle.

## Features in your vehicle

Aux Port	: 3.5 mm Stereo.
USB Socket	: 1 no. of USB socket for interface with common flash drives.
Speakers	: 2 nos. of 15+15 Watts speakers with water & dust protection.
FM Radio	: PLL based auto tuning capability in frequency range of 88-108 MHZ.
Volume Controls	: 8 steps digital "UP - DOWN" volume control.
Switch Cluster	: Water & dust proof switches with soft touch and ease convenience.
LED indicators	: FM and MP3 indication, brighter LED's for day time visibility.







### Features in your vehicle

The various switch cluster operations of music system are listed as follows:



**CAUTION**

Switch cluster has a waterproof sticker on its top, replace this sticker without fail whenever it peels off.

SYMBOLS	BUTTONS	OPERATIONS
	ON / OFF	To switch ON & OFF the system
	Volume Up	To increase volume
	Volume Down	To decrease volume
	Play / Pause	In Bluetooth mode and MP3 mode: To Play or Pause the tracks Not function in FM mode
	Forward	In Bluetooth mode and MP3 mode: To Play next track For fast forward press this switch continuously after reaching the last song use reverse to reach the first song  In FM mode: Tune to Next channel. Once highest frequency is reached use reverse button to reach lower frequency
	Reverse	In Bluetooth mode and MP3 mode: To Play previous track For fast reverse press this switch continuously after reaching the first song use forward to reach the last song  In FM mode: Tune to Previous channel. Once lowest frequency is reached use forward button to reach higher frequency

**Switching operations (⏻):**

Power on switch has 4 position toggle mode operations (refer drawn flow chart).

After switching on ignition key, press once '⏻', music system starts automatically on Bluetooth mode. At this position indicator provided for Bluetooth will start glowing continuously. To change the mode from Bluetooth to MP3 press once the button '⏻'. At this position continuously glowing the same indicator. Then next to change the mode from Mp3 to FM press once the button '⏻'. At this position continuously glowing indicator also shifts towards FM indicator.

Flash drive with MP3 songs stored in it shall be inserted before switching 'ON' music system or after switching 'ON' ignition key and removal of flash drive can be done both in ignition 'ON' and 'OFF' condition.

To switch off music system press button '⏻' once.

**NOTE**

This music system is designed to play only MP3 files stored in Flash drive. It searches MP3 files automatically and starts playing once the external source is connected.

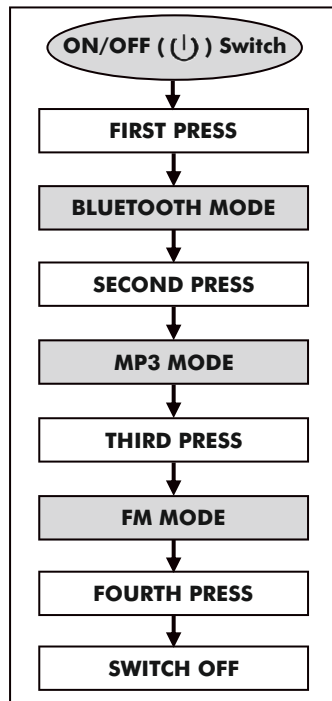



**Volume Control**

This system has 8 steps of volume control. To increase the volume by one step press ' + ' button once, keep pressing ' + ' to get required volume level.

To decrease volume use button ' — ' accordingly.

During switch 'ON' the system starts with default of 50% volume.

**CAUTION**

Always maintain pleasant sound level in public places in order to have healthy atmosphere with co riders.

**Forward / Reverse  
In Bluetooth Mode:**

Press(  ) button to switch on the Music system.

Music system will enter into "Bluetooth" mode.

Mp3 LED will start blink and FM mode continuously on for Bluetooth mode.

Switch on the Bluetooth in smart phone and scan the device.

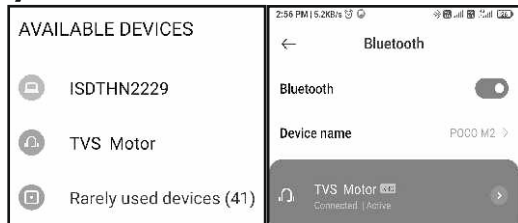

Select TVS MOTOR and pair the device.



After pairing, you can play the songs from smart phone.

Press (+) button to increase the volume and Press (-) button to decrease the volume

**NOTE**

In Bluetooth mode, song selection is through smart phone only.

**In Mp3 Mode:**

To play next song press button '  ' once. To play previous song press button '  ' once. Keep pressing above buttons continuously to get desired songs.

To fast forward press and hold button '  ' continuously for more than 2 seconds.

To fast reverse press and hold button '  ' continuously for more than 2 seconds.

## Features in your vehicle

### In FM Mode:

To tune to next channel press button '▶▶' once. To tune to previous channel press button '◀◀' once.

### Play / Pause:

It is a toggle mode switch. To pause song press button '||' once. To resume press button '||' once again. This function will not work in FM mode.

### USB DRIVE :

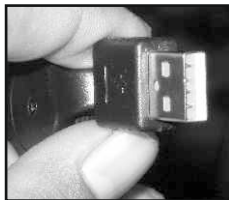

USB socket provided in the system which can directly interface with commonly available Flash drives.

Ensure the polarity of Flash drive while assembling by confirming the plastic base always at the bottom side.

Wrong forcible insertion may result in damaging the socket or drive or both.

This system has 70 mm length USB adapter cable which is part of factory fitment.

Any mobile with Flash disc emulation mode with suitable songs stored in it can be played back using suitable connecting cable.

### **NOTE**

We recommend you to switch OFF music system while starting the vehicle using electric starter.

**Aux Port :**

TVS KARGO music system is fitted with 3.5mm stereo aux port.

If you want to listen music from your music player or smart phone, use aux cable and connect your player to aux port.



Any attention grabbing activity like listening to good music while driving a high powered machine like "TVS KARGO" need to be done with adequate precautions for one's own safety and other road user's safety.

To avoid battery dropped when starting the engine using electric starter. Suggested only 30 minutes maximum for listening music when engine not in running condition.

**⚠ CAUTION**

We recommend not to use music system while it is raining, take care that no water is entering inside USB socket and headphone socket.

TVS Kargo music system is designed to work with input battery voltage of minimum 8.5 V DC. If battery voltage is less than 8.5 V, music system will not function.

**Importance**

Your safety and safety of others is very important. Operating this vehicle safely is a big responsibility .

**SAFE RIDING TIPS**

**For safe driving**

Always make a pre ride inspection before you start the vehicle. We suggest that you practice driving your vehicle in a non traffic situation until you are thoroughly familiar with your vehicle operations and its control. Always carry the fire extinguisher in vehicle and care while parking the vehicle. Do not over load the vehicle more than Gross Vehicle Weight.

**Daily checks before riding**

<b>Location</b>	<b>What to check for</b>	<b>Reference page</b>
Engine oil & Differential oil	Check the availability up to required	41 to 42
Fuel	Enough fuel for the planned distance of running	22
Brakes	Check for effectiveness, Brake pedal free play, dragging of brakes, brake sponginess.	47
Tyres	Correct tyre pressure, Adequate tread depth, No crack or cut	46
Battery	Ensure the working of Horn, Brake lamp, Head lamp All indicator lamp etc	35
Steering & suspension	Check for smoothness, any play or looseness.	
Controls (Clutch, Brake and Throttle etc.)	Check the free play, smooth operation, positive return to original position	50 to 52
Tell tale lamps	Inspect all the tell tale lamps for any warning	22
Propeller shaft, Flange, Slider block and pin.	Sufficient quantity of recommended grease	47
Differential & gearbox breather tube	Check if both gear box and differential breather tube is blocked with mud or any dirt	

## OPERATING YOUR VEHICLE

### Starting the vehicle

- Insert the ignition key in the ignition switch and turn it clockwise to ON position. (Ref page no.16, fig No.1)
- Bring the transmission to neutral. Confirm by checking if the neutral indicator lamp on dash board is lit.
- Apply choke if vehicle is in cold condition or starting in the morning. (Ref page no 24, fig No.17)
- Pull the starting lever up-wards or use electric start switch (ES model) to start the engine. (Ref page no 24, fig No.18)
- Wait for some minute and let the engine to warm up before engaging the gears and moving on.

#### CAUTION

Do not open the throttle while the choke is applied, it will cause flooding of engine and difficulty in starting.

### Setting the vehicle in motion ( Ref fig.)

- When the engine has started release the parking brake.
- Dis-engage the clutch by depressing the clutch lever.
- Rotate the gear shift twist grip downward to engage the first gear.
- Open the throttle a little by rotating the throttle grip in the clock wise direction; simultaneously release the clutch lever gently and gradually.

- The vehicle will start moving forward. As the vehicle picks up speed shift to the next higher gear. Select the required gears in similar manner.



### Setting the vehicle in motion

Km.	1st Gear	2nd Gear	3rd Gear	4th Gear
Speed	0-15km/h	15-20km/h	20-30km/h	30-55km/h

#### CAUTION

While shifting to each gear close the throttle fully and depress the clutch with out fail. Ensure that the hand brake is released before moving the vehicle.

**Stopping and parking**

- Close the throttle completely and apply the brake.
- As the vehicle speed reduces depress the clutch lever and down shift the gears.
- Bring the transmission to neutral position just before vehicle stops.
- Press the Self Starter switch continuously for 2 sec when the vehicle is in idling RPM (<1500 RPM) & Neutral condition to stop the engine, then turn ignition switch to OFF position and take out the key.
- Apply parking brake. Lock the steering by turning the handle bar to the right. (Refer page no.21.)

**⚠ WARNING**

Do not press the clutch while braking at high speeds. Always apply the parking brake while parking on gradient.

**Reverse gear operation**

- Bring the vehicle in neutral position
- Allow the vehicle to stop completely
- Press the clutch lever.
- Turn the gear change twist grip upwards to move to alert 'A' position, beeper sound can be hear. (Refer fig.)
- Turn the gear change twist grip upwards to reverse 'R' position to engage the reverse gear. (Refer fig.)
- Engage the clutch gradually to move the vehicle.

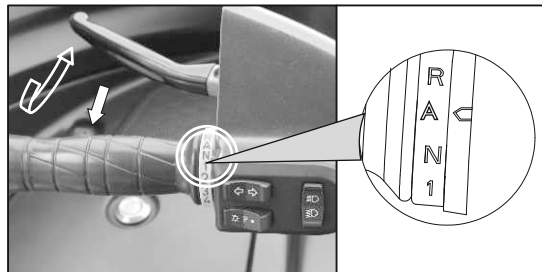

**Reverse gear operation**

**Fuel saving tips**

- Carry out the periodic maintenance services regularly at TVS authorised distributor or dealers / authorized service center.
- Perform daily checks as specified in page no 32.
- Avoid sudden and frequent braking.
- Use Start Stop function to switch OFF the engine if you have to idle the vehicle for more than 1 minutes.
- Clean, check and adjust the sparkplug gap periodically. For service procedure (See page no. 44)
- Clean air filter element as per schedule (See page53)
- Lubricate propeller shaft, slider block, pin and flange as per lubrication schedule.(Page no.47)

**Battery Location****Battery Specification**

- TVS Petrol vehicle comes with lead acid type 12V, 32Ah battery.
- Battery is located Right side of the load deck chassis.
- Battery is closed completely with the battery cover and having theft proof lock provided.

**Battery location in Petrol vehicle.**

It is recommended to top up distilled water only at Authorised proprietary Service Centres.

For maintenance of electrical system, it is recommended to approach our Distributor or Dealer / Authorized Service centers.

## Periodic Maintenance Schedule

S.No	Sub Activity	Parameters	1000	5000	10000	15000	20000	25000	30000	35000	40000	45000	50000	55000	60000	65000	70000	75000	80000	85000	90000	95000	100000			
			Kms	Kms	Kms	Kms	Kms	Kms	Kms	Kms	Kms	Kms	Kms	Kms	Kms	Kms	Kms	Kms	Kms	Kms	Kms	Kms	Kms	Kms	Kms	
			40-45	95-100	145-150	200-205	250-255	305-310	355-360	410-415	460-465	515-520	565-570	620-625	670-675	725-730	775-780	830-835	880-885	935-940	985-990	1040-1045	1090-1095			
			Days	Days	Days	Days	Days	Days	Days	Days	Days	Days	Days	Days	Days	Days	Days	Days	Days	Days	Days	Days	Days	Days		
1	<b>Clean</b>	Wash and Clean Vehicle	Every 1000Kms																							
2	<b>Check &amp; Top up</b>	Engine Oil	Every 2000Kms																							
3		Differential oil		●		●		●		●		●		●		●		●		●		●		●		
4		Brake fluid in brake fluid reservoir		●		●		●		●		●		●		●		●		●		●		●		
5		Coolant level		●		●		●		●		●		●		●		●		●		●		●		
6		Clutch Lever End Play and Engine end Play adjustment /setting		●	●	●	●	●	●	●	●	●	●	●	●	●	●	●	●	●	●	●	●	●	●	
7		Tyre pressure	Every 500Kms / Daily																							
8		Lubricate Brake Pedal Fulcrum Joint		●		●		●		●		●		●		●		●		●		●		●		
9	Clean and Adjust Steering Friction Plate		●		●		●		●		●		●		●		●		●		●		●			
10	<b>Check Inspect &amp; Top up</b>	Brake fluid in brake fluid reservoir			●		●		●		●		●		●		●		●		●		●			
11		Coolant level		●		●		●		●		●		●		●		●		●		●		●		
12		Cooling system circuit leak check		●		●		●		●		●		●		●		●		●		●		●		
13		Battery Electrolyte Level			●		●		●		●		●		●		●		●		●		●		●	
14	<b>Check &amp; Adjust</b>	Engine foundation bolt		●		●		●		●		●		●		●		●		●		●		●		
15		Brake Effectiveness		●		●		●		●		●		●		●		●		●		●		●		
16		Fasteners of Door assy (hinge) & Striker assy, dash board, rear view mirror wind shield, Soft top frame, latch nut and body		●		●		●		●		●		●		●		●		●		●		●		
17		Valve tappet clearance		●		●		●		●		●		●		●		●		●		●		●		
18		Oil circulation at cylinder over head camshaft		●		●		●		●		●		●		●		●		●		●		●		



## Periodic Maintenance Schedule

S.No	Sub Activity	Parameters	1000	5000	10000	15000	20000	25000	30000	35000	40000	45000	50000	55000	60000	65000	70000	75000	80000	85000	90000	95000	100000			
			Kms 40-45 Days	Kms 95-100 Days	Kms 145-150 Days	Kms 200-205 Days	Kms 250-255 Days	Kms 305-310 Days	Kms 355-360 Days	Kms 410-415 Days	Kms 460-465 Days	Kms 515-520 Days	Kms 565-570 Days	Kms 620-625 Days	Kms 670-675 Days	Kms 725-730 Days	Kms 775-780 Days	Kms 830-835 Days	Kms 880-885 Days	Kms 935-940 Days	Kms 985-990 Days	Kms 1040-1045 Days	Kms 1090-1095 Days			
19	<b>Check &amp; Adjust</b>	Carburetor - idle speed, CO%, HC	●		●		●		●		●		●		●		●		●		●		●			
20		Check play of all control cables and adjust if required	●		●		●		●		●		●		●		●		●		●		●			
21		Tyre pressure	●		●		●		●		●		●		●		●		●		●		●			
22		Radiator mounting screw adjustment	●		●		●		●		●		●		●		●		●		●		●			
23		Steering Lock Nut	●		●		●		●		●		●		●		●		●		●		●			
24		Handle bar bolt Tightness	When ever customer complaint																							
25		Wheel Rim Nut Tightness			●		●		●		●		●		●		●		●		●		●		●	
26		Body Mounting bolts			●		●		●		●		●		●		●		●		●		●		●	
27		<b>Replace</b>	Engine oil	●		●		●		●		●		●		●		●		●		●		●		
28			Oil Filter	●		●		●		●		●		●		●		●		●		●		●		
29	Differential oil		●		●		●		●		●		●		●		●		●		●		●			
30	Spark plug				●		●		●		●		●		●		●		●		●		●			
31	Air filter element										●										●					
32	Brake Shoe									●													●			
33	Breather Tube											●														
34	Coolant pump assy		1,20,000Kms																							
35	Water pump Damper assy & Bolt		40,000Kms / 1Yrs																							
36	Radiator & Cooling system hoses		70,000Kms / 2Yrs																							

S.No	Sub Activity	Parameters	1000	5000	10000	15000	20000	25000	30000	35000	40000	45000	50000	55000	60000	65000	70000	75000	80000	85000	90000	95000	100000		
			Kms	Kms	Kms	Kms	Kms	Kms	Kms	Kms	Kms	Kms	Kms	Kms	Kms	Kms	Kms	Kms	Kms	Kms	Kms	Kms	Kms	Kms	Kms
			40-45	95-100	145-150	200-205	250-255	305-310	355-360	410-415	460-465	515-520	565-570	620-625	670-675	725-730	775-780	830-835	880-885	935-940	985-990	1040-1045	1090-1095		
			Days	Days	Days	Days	Days	Days	Days	Days	Days	Days	Days	Days	Days	Days	Days	Days	Days	Days	Days	Days	Days		
37	Replace	Front shock absorber	70,000Kms																						
38		Rear shock absorber	70,000Kms																						
39		Load Body Seating Balata Sheet	70,000Kms																						
40	Clean	Vehicle	●	●	●	●	●	●	●	●	●	●	●	●	●	●	●	●	●	●	●	●	●		
41		Radiator core for dust or mud accumulation & clean from out side if required		●	●	●	●	●	●	●	●	●	●	●	●	●	●	●	●	●	●	●	●	●	
42		Air filter element	●	●	●	●	●	●	●	●	●	●	●	●	●	●	●	●	●	●	●	●	●	●	
43		fuel tap (strainer only)		●	●	●	●	●	●	●	●	●	●	●	●	●	●	●	●	●	●	●	●	●	
44		Petrol tank									●								●						
45		Oil strainer (replace if damaged)	●	●	●	●	●	●	●	●	●	●	●	●	●	●	●	●	●	●	●	●	●	●	
46		Decarbonize cylinder head and piston				●					●					●			●					●	
47		Hose cleaning (All). Replace, if damaged										●													
48		Brake Shoe Liner			●	●	●	●	●	●	●	●	●	●	●	●	●	●	●	●	●	●	●	●	
49		Coolant tank	Once in a year																						
50		Cooling fan assembly	70,000Kms / 2Yrs																						
51		Inspect	Engine Breather Tube		●	●	●	●	●	●	●	●	●	●	●	●	●	●	●	●	●	●	●	●	
52			Compression pressure		●	●	●	●	●	●	●	●	●	●	●	●	●	●	●	●	●	●	●	●	●
53			Adjuster assembly chain tensioned spring		●	●	●	●	●	●	●	●	●	●	●	●	●	●	●	●	●	●	●	●	●
54	Pipe nut joints (cracks & damages)			●	●	●	●	●	●	●	●	●	●	●	●	●	●	●	●	●	●	●	●	●	

S.No	Sub Activity	Parameters	1000	5000	10000	15000	20000	25000	30000	35000	40000	45000	50000	55000	60000	65000	70000	75000	80000	85000	90000	95000	100000	
			Kms 40-45 Days	Kms 95-100 Days	Kms 145-150 Days	Kms 200-205 Days	Kms 250-255 Days	Kms 305-310 Days	Kms 355-360 Days	Kms 410-415 Days	Kms 460-465 Days	Kms 515-520 Days	Kms 565-570 Days	Kms 620-625 Days	Kms 670-675 Days	Kms 725-730 Days	Kms 775-780 Days	Kms 830-835 Days	Kms 880-885 Days	Kms 935-940 Days	Kms 985-990 Days	Kms 1040-1045 Days	Kms 1090-1095 Days	
55	<b>Inspect</b>	Electrical connection checking			●	●	●	●	●	●	●	●	●	●	●	●	●	●	●	●	●	●	●	
56		Rubber Bellow for Crack or Damage			●	●	●	●	●	●	●	●	●	●	●	●	●	●	●	●	●	●	●	
57		Petrol hose			●	●	●	●	●	●	●	●	●	●	●	●	●	●	●	●	●	●	●	●
58	<b>Electrical</b>	Check all lights, horn & switches functioning			●	●	●	●	●	●	●	●	●	●	●	●	●	●	●	●	●	●	●	
59	<b>Greasing &amp; Lubrication</b>	Steering races & balls			●	●	●	●	●	●	●	●	●	●	●	●	●	●	●	●	●	●	●	
60		Speedo gear & pinion	●		●	●	●	●	●	●	●	●	●	●	●	●	●	●	●	●	●	●	●	
61		Speedo cable inner			●	●	●	●	●	●	●	●	●	●	●	●	●	●	●	●	●	●	●	●
62		Muff cup (Flange)			●	●	●	●	●	●	●	●	●	●	●	●	●	●	●	●	●	●	●	●
63		Brake lever fulcrum point			●	●	●	●	●	●	●	●	●	●	●	●	●	●	●	●	●	●	●	●
64		Hand starter front shaft			●	●	●	●	●	●	●	●	●	●	●	●	●	●	●	●	●	●	●	●
65		Hand starter rear shaft (Engine End)			●	●	●	●	●	●	●	●	●	●	●	●	●	●	●	●	●	●	●	●
66	<b>Others</b>	Tyre Rotation		●	●	●	●	●	●	●	●	●	●	●	●	●	●	●	●	●	●	●	●	●
67		Check battery voltage and charge if required			●	●	●	●	●	●	●	●	●	●	●	●	●	●	●	●	●	●	●	●
68		Apply petroleum jelly on battery terminals			●	●	●	●	●	●	●	●	●	●	●	●	●	●	●	●	●	●	●	●

**NOTE**

Before lubricating each part, clean them thoroughly, remove rusty spots if any. Lubricate exposed parts which are subject to rust with either engine oil or grease whenever the vehicle is used / operated under wet or rainy conditions perform the Do it yourself activity by Customers as per the Mentioned Period. Air Filter to be Cleaned Frequently incase vehicle is operating in a Dusty Environment During the Rainy Season / Operating Vehicle in a water logged Areas, recommended to clean & replace with new Grease allover the Lubrication points.

Product	Recommended grade	Manufacturer	Quantity.
Engine oil	(20W40 API-SL, JASO Ma2)*	TVS Tru4 Duramate oil	1750 ml
	(20W50 API-SL, JASO Ma2) <sup>#</sup>	or TVS Tru4 Duralife oil	1750 ml
Differential	(20W40 API-SL, JASO MA2)*	TVS Tru4 Duramate oil	250 ml
	(20W50 API-SL, JASO Ma2) <sup>#</sup>	or TVS Tru4 Duralife oil	250 ml
Brake fluid	DOT 3 / DOT 4	TVS Girling	250 ml
Grease (Muff cup)	IPOL IPLEX RR3	IPOL	120g
Grease (Steering)	BECHEM PREMIUM III	BECHEM	30g
Coolant	Antifreeze -37° , 50:50	Castrol Radicool SFO Premix	1400ml

**⚠ CAUTION**

Use only TVS Motor Recommended genuine lubricant & coolant.

\* Applicable only for Asia & Asean Country's

<sup>#</sup> Applicable only for Africa, Middle east & Latam Country's

**SELF MAINTENANCE PROCEDURE**

The following maintenance can be done by your self to ensure good performance of your vehicle.

**⚠ CAUTION**

Attending major maintenance work and repairs yourself can affect the performance of your vehicle. Approach TVS authorised Dealer or service center in the case of any major problem.

**Engine Oil level checking and topping up**

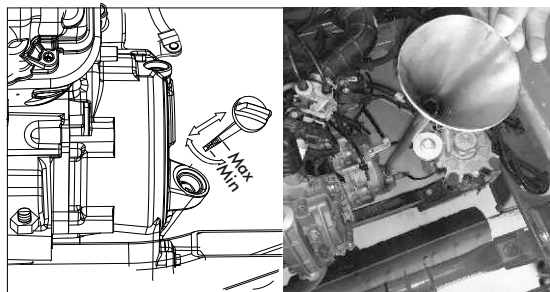

**Engine Oil level checking and topping up**

Engine Oil level can be measured by means of dip stick provided on the cover crank case as shown in the fig.

- Park the vehicle on level ground
- Allow 5 to 10 min for the oil to settle down.
- Remove the dip stick from its location.
- Wipe it clean with dry cotton waste.
- Re-insert the dip stick with out threading inn.
- Again take out the dipstick to note the oil level, it should be In-between the 'Min & Max' level or up to 'Max' level.
- In case the oil level is below the 'MIN' level mark top it up to 'Max' level.
- Insert and tighten the dip stick completely.

**Differential Oil level checking and topping up**

Differential oil level can be checked with the help of oil level checking bolt provided on cover differential.

- Park the vehicle on the level ground.
- Allow 5 to 10 min. for the oil to settle down.
- Unscrew the oil level check bolt using 10mm spanner
- The oil level is correct, if oil just starts flowing out when the plug is removed.
- If not, oil level is less, top up with recommended oil, by using special toll till the oil starts flowing out.
- To top up oil loosen filler bolt using 17mm spanner.
- Fill recommended oil by using special tool to fill and tighten filler bolt with washer.
- Tighten the level plug with washer with out fail.

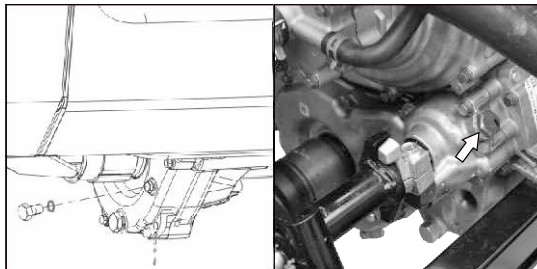

**Differential oil level checking and topping up**

Tool name	Tool size
Ring spanner, Socket spanner	10mm, 17mm

**Engine Oil Replacement**

- Run the Engine for a few minutes to warm up the oil
- Park the vehicle on level ground
- Allow some time for the oil to settle down.
- Place a oil pan under the drain plug and un-screw hex. flange nuts (2nos.) and take out the cover oil strainer(B). Also Remove 17 mm Magnetic drain bolt provided on the crank case LH, and clean.

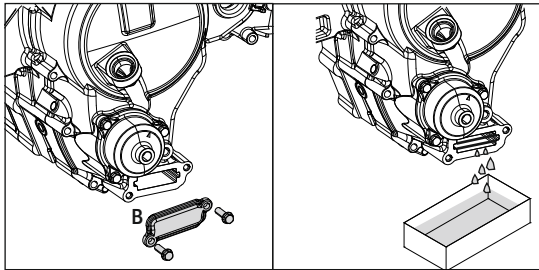

**Engine Oil Replacement**

- Refit drain plug along with plain washer and tighten it.
- Remove the dip stick and pour the correct quantity of recommended oil by using special tool.
- Insert and tighten the dip stick completely.
- Check the oil level.
- Replace engine oil at every 10000 kms.

Tool name	Tool size
Ring spanner	10 mm

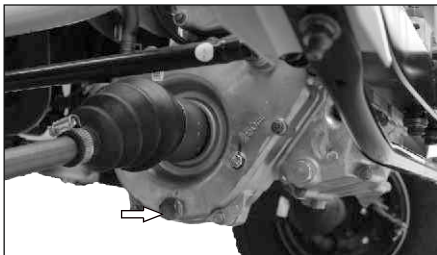

### Differential Oil Replacement

- Run the Engine for a few minutes to warm up the oil
- Park the vehicle on level ground
- Allow some time for the oil to settle down.
- Place a pan under the drain plug and remove the oil drain plug with plain washer. Drain the oil completely.
- Refit drain plug along with plain washer and tighten it.

- Loosen and take out the filler bolt and fill correct quantity of recommended oil by using special tool.
- Tighten filler bolt. Check oil level
- Replace differential oil at every 10000Km

Tool name	Tool size
Ring spanner, Tubular spanner	17mm

 **CAUTION**

Always use recommended transmission, differential oil and special tool. Two different grade and brand of oil should not be mixed



**LOW Engine Oil Pressure Indicator**

- It is located on cluster assembly tell tale lamp as shown in the figure.
- This indicator must glow in Ignition switch ON and before starting the engine.



- It must switch off as soon as engine start i.e., engine rpm increases, or else bring the vehicle to authorized distributor or dealer / authorized service center

**⚠ CAUTION**

Always use recommended transmission, differential oil and special tool. Two different grade and brand of oil should not be mixed

**SPARK PLUG**

**Cleaning the spark plug**

- Pull out the suppressor cap from the spark plug.
- Remove the spark plug by using plug spanner provided in the tool kit.

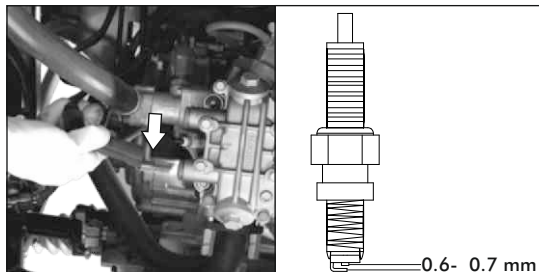

- Clean carbon from the electrodes and around the base with the help of spark plug cleaner.
- Adjust the gap to the specified limit if incorrect
- Spark plug should be replaced at every 10000km.

## Self maintenance procedure

Tool name	16 mm plug spanner
Spark plug Gap	0.6 - 0.7mm
Spark plug Type	Bosch UR 6 DE
Spark plug cap	Resistive

 **CAUTION**

To adjust spark plug gap or replacement approach our Distributor or Dealer / Authorized service center.

Plug the spark plug hole when the spark plug is removed to avoid entry of foreign particles inside cylinder.

Always use recommended make and type of spark plug.

### Changing tyres and wheels

#### 1. Spare wheel removal

- Spare wheel is fitted to the Left Side chassis of the vehicle below the load deck.
- Gently pull out the spare wheel cover, Remove the Spare wheel lock using Key, then Loosen the spare wheel mounting nuts along with spring washer using 17 mm tubular spanner. ( 2nos.) ( A , B).
- Take out the spare wheel.



**Spare wheel removal**

**NOTE**

Mount the spare wheel on the bracket properly and tighten the nuts thoroughly, close the spare wheel with cover.

**Tyre and wheel changing procedure.**

**Removal**

- Apply parking brake
- Loosen the wheel retaining nuts. (2 nos.)
- Take out the Jack & Rod from RH Side Utility Box.
- Place the jack as shown in the fig. (For removing front wheel B (Cross Member). rear wheel A. (Trailing Arm)
- Lift up the vehicle until the wheel clears the ground.
- Remove the retaining nuts and take out the wheel.

**Assembly**

- While assembling the spare wheel tighten the wheel nuts diagonally.
- Lower the vehicle slowly to the ground then tighten the nuts fully to the recommended torque.

Tool name	Tool size
Ring spanner, Socket spanner	17mm

**Tyre Pressure**

Load	Driver alone (kerb with driver)		Laden - 400 kg payload (Driver + 325kg)		Above - 400 kg payload >(Driver + 400kg)	
	FR	FR	FR	FR	FR	FR
Pressure (psi)	30	30	30	50	45	60

**Tyre Assembly**

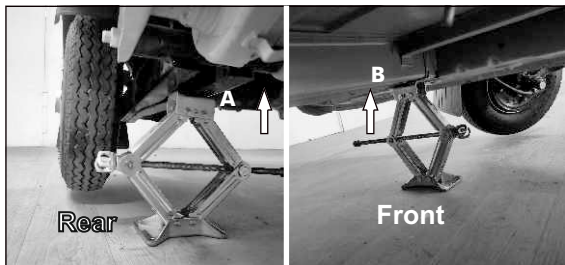

**Jack position rear - A**

**Jack position front - B**

Rotation of tyre is recommended for uniform tread wear on all the wheel positions to achieve optimum tyre life.

So it is advised that rotation of tyres be carried out after every 5000 kms.

**CAUTION**

The best tyres should always be fixed at the rear wheels which are driving wheels, thereafter follow the sequence of rotation as shown in the fig.

It is recommended to replace the tyre when the tyre wears off to the Tyre Wear Indicator level (indicated by TWI on the tyre)

**Tyre Rotation**

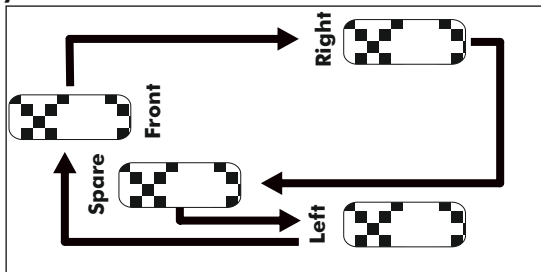

**Tyre rotation**

**BRAKES**

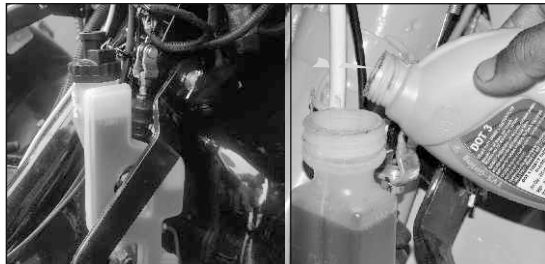

**Brake fluid level checking & topping up**

**Brake fluid level checking**

Incase Brake oil level is low immediately brake oil warning lamp glows on the telltale lamp. It can be checked on the brake fluid tank fitted on the Right side under the dash board in the driver cabin.

The level should be in-between the 'Max & Min' level.

If it is below the 'Min' level top up using recommended brake fluid up to 'Max' level.

**▲ WARNING**

In the case of changing brake fluid it is recommended to approach our Distributor or Dealer / Authorized Service centers.  
Avoid dust entry to the fluid reservoir while topping up.  
Bellows should be kept in good condition and replace.

**Rubber bellows for propeller shaft**

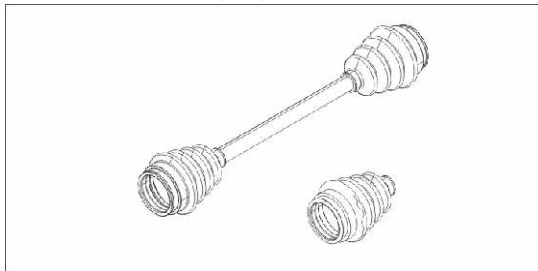

**Rubber bellows**

Bellows should be kept in good condition and replaced immediately if torn or cracked by approaching our Distributor or Dealer / Authorized service centers.  
Torn or cracked bellows allow dust and water into the propeller shaft flanges which will cause damage to flange, slider block and pins. Inspect the bellows regularly.

**ELECTRICAL**

**Head lamp bulb removal**

To replace bulb

- Remove the headlamp bulb holder ( A ) from reflector housing which is located under the dash board.
- Gently pull out the Rubber Boot (B) from reflector housing.
- Un-lock the clip ( C ) by loosening the star screw using star screw driver to take out the bulb assembly.
- Push the bulb in and turn it in anti-clockwise direction to remove the bulb from holder.
- Push the new bulb in and turn it in clockwise direction to fit new bulb.
- Put back the clip & tighten the start screw. Assemble Rubber boot & bulb Holder into reflector housing

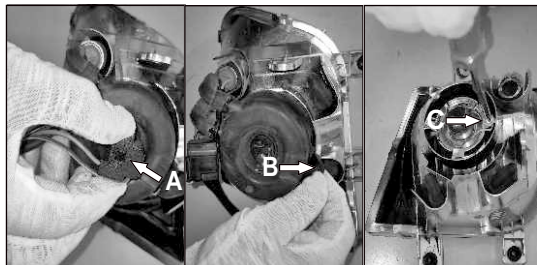

**Tail/brake/ rear turn signal lamp bulb**

- Loosen and remove screws holding the lens.
- Remove lens. Push in and twist in anti clockwise direction to remove bulb.
- Replace bulb and assemble back in reverse order of disassembly.

**Front turn signal bulb replacement**

- Loosen and remove screws ( 1 nos. ) (A) holding the lens.
- Remove lens. Push the bulb in and twist in anti clockwise direction to remove bulb.
- Replace bulb and assemble back in reverse order of removal.

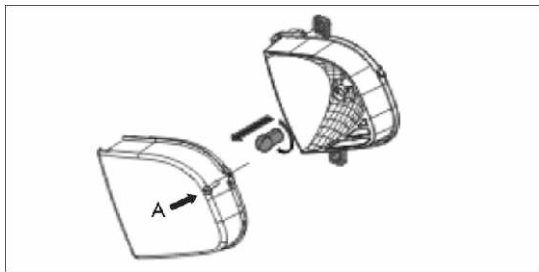

**Bulb removal**

**Battery fuse replacement**

The fuse case fitted on the ISG cordset unit contains a 60 A (1-nos.) fuse. If the fuse is blown off, turn the ignition switch to OFF position. Open the fuse case, take out the fuse from copper fuse holder and replace it with spare fuse provided. Refer the figure.

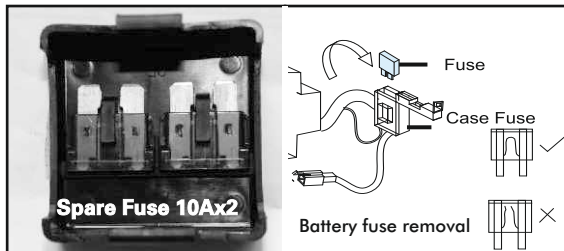
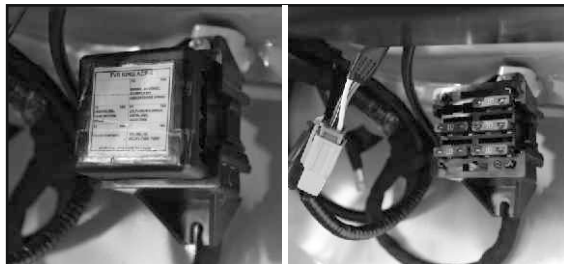

Two fuses of 10A is located below the dash board in side the fuse case. Check the respective fuse if Self Start, horn, bay lamp, faremeter, wiper, hazard and cluster lamps is not working, replace the fuse with spare fuse if blown off.



**Throttle cable adjustments**

**Throttle cable adjustment**

Throttle cable free play can be measured by holding the adjuster and pulling the cable gently out. The gap between the adjuster and cable outer is the free play.

To adjust the throttle cable free play

- Loosen the lock nut( 1) by holding adjuster (2)
- Adjust the cable slack by turning the adjuster (2) in or out to obtain the recommended free play.
- After adjusting the free play, holding the adjuster, tighten the lock nut.

Throttle cable free play : 1 - 2 mm	
Tool name	Tool size
Double end spanner	10 mm (2)nos.

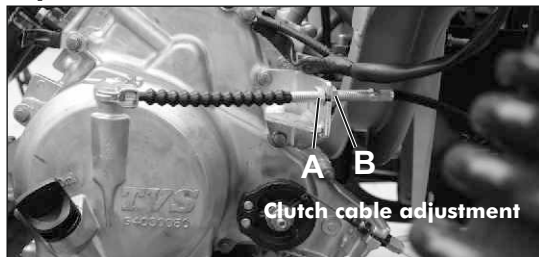

**Clutch cable adjustment**

Clutch free play is measured at the clutch lever end.

- Loosen lock nut ( A ).
- Adjust the play adjuster nut ( B ) in or out to get the specified play at the lever end.
- After adjusting the play holding the adjuster nut lock the lock nut.

Clutch free play: 10 - 20 mm	
Tool name	Tool size
Double end spanner	10 mm, 12mm
<b>⚠ CAUTION</b>	
Too much or too less clutch free play will damage the clutch plates affecting the performance of the vehicle. Clutch play should be adjusted only when the engine is cold.	



**Clutch cable inner replacement**

**Removal**

- Loosen the stopper nut at rear
- Remove cable from release lever (A)
- Take out the cable from stopper
- Disconnect cable from lever end
- Pull out cable inner from lever end



**Clutch cable assembly at engine end**

Tool name	Tool size
Double end spanner	10 mm, 12mm

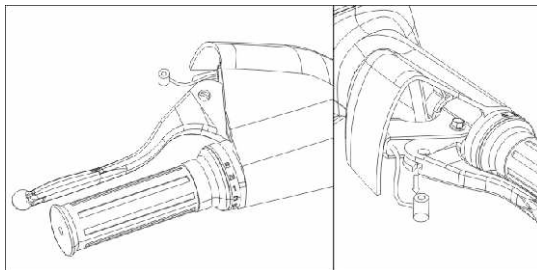

**Clutch cable assembly at pulley end**

**Assembly**

- Connect cable to clutch lever
- Insert cable inner through cable outer
- Connect adjuster to stopper clutch cable at engine end
- Pull out clutch inner through clutch release lever and pinge bolt
- Tighten pinge bolt
- To adjust free play, loosen pinch bolt pull cable in or out and tighten pinge bolt.

**Gear cable inner replacement**

**Removal**

- Loosen lock nut (A) and adjuster nut (B) at engine end
- Remove cover handle bar (C) by loosening two screws
- Remove the lock clip (D)
- Remove the handle bar sleeve and take out pulley gear shift.
- Pull out cable inner gear shift
- Loosen pulley gear shift nut at engine end and take the pulley out

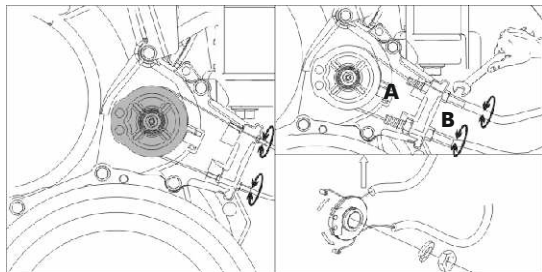

**Gear cable assembly at engine end.**

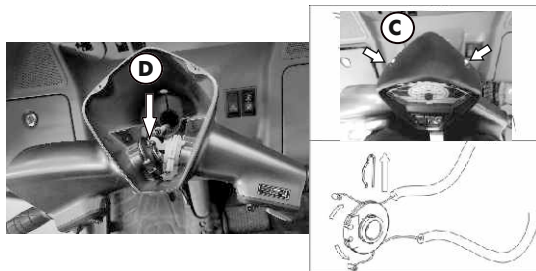

**Gear cable assembly at handlebar end.**

**Assembly**

- Connect gear cable inner to pulley gear shifter at handle bar end.
- Insert cable inner through cable outer and adjuster
- Take out adjuster gearshift cable from stopper
- Loosen pulley nut and take out pulley
- Pull out cable inner and connect to pulley at engine end through ping bolts
- Apply oil on inner and route it through outer and holes provided in the pulley gear shifter and tighten ping bolts.

- Connect adjuster to stopper gear cable at engine end.
- Connect the pulley to shaft gear shifter and tighten nut.
- Connect pulley to handle bar end and insert sleeve in to handle bar
- Lock the pulley with clip
- Adjust cable free play by loosening lock nut and turning adjuster nut in or out.
- Refit cover handle bar and tighten screws.



### **Air filter cleaning**

#### **Removal**

- Air filter is present below the load deck of RH side.
  - Clean the Outer Surface of the air filter throughly.
  - Loosen the three lock clip provided on the cover air filter, and take out the cover air filter.
  - Take out the paper filter cartridge.
  - Blow the compressed air from inside out of the filter element to free the filter from dust particle.
  - Replace the Paper filter element along with foam every 40000 kms. or found damaged for better performance of the vehicle and engine life.
- Clean the cover air filter and case air filter.
  - Re-assemble the air filter element in the reverse order of removal. Ensure all the three clips are clamped with cover air filter and locked properly.

Cleaning the Paper filter element	Every 10000 kms
Replacement of Paper filter element	Every 40000 kms

**CAUTION**

While assembling the cover air filter locate the groove of cover air filter properly. (Match Arrow Mark provided on Cover as well as Air filter Body.)  
In case vehicle is operating very dusty environment, it is recommended to clean the air filter frequently for better life of engine

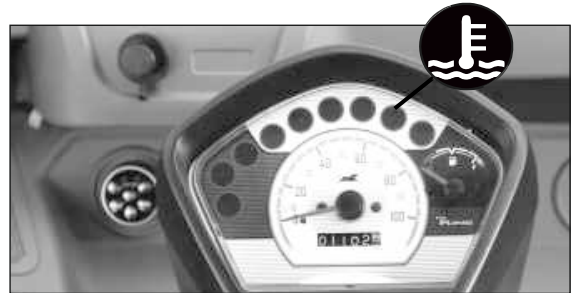

**Engine High temperature Warning Lamp**

**WARNING**

Approach nearby TVS Authorised Distributor or Dealer / Service Center incase the high engine temperature warning lamp glows contentiously.

Engine won't get started incase of Temperature Sensor failure or Open circuit.

**Engine High Temperature Warning Lamp**

It is located on cluster assembly tell tale lamp as shown in the figure.

This indicator will glow only when engine temperature goes high due to some malfunction in the cooling system.

If you ride the vehicle with the High temperature warning lamp ON, engine goes to Limphome mode and engine gets switch off to avoid seizure.

**Topping up the Coolant inside coolant Reservoir**

- Coolant need to be topped up incase coolant level in the reservoir reach minimum level. Coolant reservoir is located bellow load deck, Rear RH side of Engine compartment. To top up the Coolant using funnel.
- Open the Cap reservoir (A) by rotating anti-clockwise.
- Top up the recommended coolant up to MAX level by using funnel.
- Close the Reservoir cap

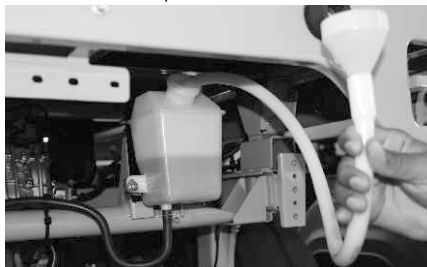

**CAUTION**

Top up only TVSM recommended Premixed Coolant.  
Do not over fill the reservoir.  
Do-not mix the different brand coolant.

**TVSM Recommended Coolant : Castrol Radicool SFO Premix**

**Charging and Low Battery Voltage Indicator**

It is located on cluster assembly tell tale lamp as shown in the figure.

This indicator will glow only when battery voltage goes low due to some malfunction in the ISG unit and battery.

If you ride the vehicle with the Charging and low battery voltage indicator lamp ON, battery goes to spoil and vehicle gets switch off to avoid battery damage.



**WARNING**

Approach nearby TVS Authorised Distributor or Dealer / Service Center incase the Charging and Low Battery Voltage Indicator lamp glows contentiously.

**Service Record Sheet**

S.No	Description	Odometer reading	Job card number / date	Servicing dealers stamp & sign
1.	1st Service			
2.	2nd Service			
3.	3rd Service			
4.	4th Service			
5.	5th Service			
6.	6th Service			
7.	7th Service			
8	8th Service			
9.	9th Service			
10.	10th Service			
11.	11th Service			
12.	12th Service			
13.	13th Service			
14.	14th Service			
15.	15th Service			
16.	16th Service			

**Models**

TVS King GK LT / GK PF /  
GK DAC - (Petrol With Load tray / Platform  
/Drive Away Chassis)

**Engine**

Type - 4 Stroke, liquid Cooled, Single  
Cylinder SI Engine

Displacement - 225.8 cc

Maximum Power - 7.8 kW (10 bhp) @ 4750 rpm

Maximum Torque - 18.5 Nm @ 3000 rpm

Maximum speed - 65 ± 2 km/h

Engine idling rpm - 1200 ± 200 rpm

Idle CO - <0.5% @ Tail Pipe, HC: 500 ppm

Air Filter Type - Cylindrical- Paper filter with dry foam

Starting System - Electric (i-Touch Start) & Hand Start

Max Gradeability in 1st gear - 10°

**Transmission**

Clutch Type - Multi plate wet type

Gear - Manual, 4 Forward & 1 Reverse

Differential - Integral with Engine

\* Specifications mentioned are subject to change on account of contentions improvement in the Product without prior notice.

**Chassis & Dimensions**

Frame - Semi Monocoque chassis - Pressed longitudinal & cross members

Overall Length - 3010 mm

Overall Width - 1350 mm

Overall Height - 1720 mm

Ground Clearance - 169 mm

Wheel Base - 1990 mm

Rear Wheel Track - 1150 mm

Kerb Weight with 90% Fuel - 416 kg (LT - Load tray)  
- 394 kg (PF - Plat Form)  
- 345 kg (DAC - Drive Away Chassis)

Maximum GVW - 816 kg (LT - Load tray)  
- 794 kg (PF - Plat Form)  
- 745 kg (DAC - Drive Away Chassis)

Load tray (length, width & height) - 1500 x 1300 x 280 (LT)

Load tray (length & width) - 1500 x 1300

Load tray (length, width & height) - NA

**Tyres**

Size Front / Rear - 4.00-8, 76E 6PR / 4.00-8 76E 6PR

Load	Driver alone (kerb with driver)		Laden - 400 kg payload (Driver + 325kg)		Above - 400 kg payload >(Driver + 400kg)	
	FR	RR	FR	RR	FR	RR
Pressure (psi)	30	30	30	50	45	60

**Brakes**

Front & Rear	- Drum & Foot Operated, Hydraulic, Internally Expanding Shoe with Auto Adjuster type
Parking	- Hand brake (mechanical)
Brake fluid grade	- DOT 3 / DOT 4

**Electrical**

Type	- 12V DC, Negative Earth
Ignition Battery	- 12V, 32 Ah
generator	- 12V, 245Watt
Spark plug	- Bosch UR6DE
Head lamp	- 35/35W, DC Twin head lamp
Position lamp	- 12V, 5W x 2
Tail/Brake lamp	- 12V, 5/21W X 2
Revers lamp	- 12V, 21W x 1
Turn Signal Lamp	- 12V, 10W X 4
Speedometer lamp	- 12V, 1.75W x 1
All instrument panel lamp	- 12V, 1.75W x 6
Horn	- 12V, DC
Fuse	- 12V, 60A x1, 20Ax1 & 10A x 6

\* Specifications mentioned are subject to change on account of contentious improvement in the Product without prior notice.

**Capacity**

Fuel tank	- 15 ± 0.5 litre
Engine oil grade	- TRU4 DURAMATE oil (20W40 API-SL, JASO Ma2)*
	- TRU4 DURALIFE oil (20W50 API-SL, JASO Ma2)*
Engine oil quantity	- 1750 ml & 1800 ml While Overhauling
Differential oil grade	- TRU4 DURAMATE oil (20W40 API-SL, JASO Ma2)*
	- TRU4 DURALIFE oil (20W50 API-SL, JASO Ma2)*
Differential oil quantity	- 250 ml & 300 ml While Overhauling
Coolant quantity including reservoir	- 1400 ml Castrol Radicool SFO Premix
Brake fluid quantity	- 250 ml
Brake fluid grade	- DOT 3 / DOT 4

\* Applicable only for Asia & Asean Country's

\* Applicable only for Africa, Middle east & Latam Country's