

Dear Racer,

Thank you for choosing the TVS Apache RTR 200 Fi 4V.

This race machine wins the race to the future with futuristic technology and a revamped aesthetic. It features new decals, an LED headlamp, refreshed mirrors, a secure wave bite key with over 9,000 combinations, high performance radial tyres, a refreshed colour for the engine case, and convenient feather touch start technology.

The performance machine also comes with a 1st-in-class Race Tuned Slipper Clutch technology & Dual-Channel ABS with RLP (Rear wheel Lift-off Protection). The Slipper clutch enables quick downshifts to attack every corner on the track while the ABS with RLP offers quick detection and recovery of the wheel lock achieving superior braking performance.

There's always a deep connection between man and race machine. The TVS Apache RTR 200 Fi 4V takes that connection to another level, with TVS SmartXconnect – a Bluetooth based connection between your smartphone and race machine that provides call and SMS notifications, turn-by-turn navigation, and comprehensive racing statistics to give you a winning edge.

As a proud owner of the TVS Apache RTR 200 Fi 4V, you are now part of the 4 million strong TVS Racing family.

This manual explains the features and operations of your TVS Apache RTR 200 Fi 4V. Please read it carefully and follow the instructions to enjoy the ultimate racing experience. To prolong your journey on the TVS Apache RTR 200 Fi 4V, we urge you to get your services only at TVS Motor Company Distributor, Dealers or Authorized Service Centers.

Here's your new lap on the Apache RTR 200 Fi 4V.

TVS MOTOR COMPANY LIMITED



Take time to familiarize yourself with your TVS APACHE RTR 200 Fi 4V and its performance characteristics.

This Owner's Manual contains a host of useful information. Please take the time to read this manual before you ride your new TVS APACHE RTR 200 Fi 4V. Get familiarised with the operation of your motorcycle for maximum safety and pleasure. The better you know your vehicle, the more pleasure you will experience riding your new vehicle. Ensure that anyone else riding your TVS APACHE RTR 200 Fi 4V does the same.

All information, illustrations, photographs and specifications contained in this owner's manual are based on the latest product information available at the time of this publication. TVS Motor Company Limited may, however, incorporate modifications or improvements on its vehicles at any time without notice, and therefore, in such events it is possible that the relevant part of the owner's manual does not apply to your vehicle.

Prior permission of TVS Motor Company Limited is required for quoting, copying or reproducing any part of this owner's manual.

i Note

Accessories shown in the picture may not be a part of standard equipment. Pictures shown in the manual are of TVS Apache RTR 200 Fi 4V with dual channel ABS until otherwise specified.

Your motorcycle is provided with always glowing head lamp. High beam can be activated once engine is started, otherwise low beam is always ON.



Operating this vehicle safely is an important responsibility of the rider. To help you make decisions on safety, we have provided necessary operating procedure and other information in the owner's manual. This information alerts you on potential hazards that could hurt you or others. Since it is not possible to warn you about all the hazards associated with operating or maintaining the vehicle, you must use your own judgement.

You will find important safety information in following form in the owner's manual as well as the service handbook. These words carry the following connotations:

Warning

*Disregarding this message might result in **injury to the rider or deadly accidents.***

Caution

*This message indicates special procedures or precautions to be followed to **avoid damage to the vehicle.***

Note

*This message provides further clarification for **clear understanding of any particular information.***

| | |
|--------------------------------------|----|
| Running-in information | 01 |
| Antilock braking system | 02 |
| Safe riding tips | 07 |
| Know your TVS Apache RTR 200 Fi 4V | 11 |
| Riding your TVS Apache RTR 200 Fi 4V | 57 |
| Maintenance | 63 |
| Service record sheet | 87 |
| Technical specifications | 90 |



The first 1000 km is a crucial part of your motorcycle. Proper running-in operation during this period helps in ensuring a **maximum life** and **smooth performance** of your motorcycle.

The reliability and performance of your motorcycle depends on the special care and restraint exercised during the running-in period. It is especially important that you avoid operating the engine in high speed (RPM), which could expose the engine parts to excessive stress. Recommended speed during the running-in is:

Maximum 50 km/h speed upto 750 km (vary the engine speed for better mating of parts).

The first free service at 500 ~ 750 km is most important. During running-in period all the engine components and other parts will have set in. All adjustments to be restored, all fasteners to be tightened. Engine cum transmission oil to be replaced. Timely performance of the first free service will ensure optimum service life and performance from the engine.

Caution

Replacing the engine cum transmission oil during first service is most important for better life of engine. Always use TVS TRU4 FULLY SYNTHETIC oil (SAE 10W30 API-SL, JASO MA2) for better performance and life.

*Since your motorcycle is fitted with Evaporative Emission Control System, **the motorcycle should not be laid on the floor during water wash.** Else it may lead to difficulty in starting and improper running of the motorcycle.*

Anti-Lock Brake System (ABS)

Your motorcycle is fitted with an Anti-lock braking system (ABS) which is designed to prevent skidding and help riders to maintain steering control during emergency-stopping situation in dry or wet roads, loose gravels etc. In case of single channel ABS system, the ABS system is provided only on the front brake whereas dual channel system has the ABS system on both front and rear brakes.

How does ABS work?

When a rider applies the front brake (in single channel system) or any of the brake (in dual channel system) continuously, as he detects a dangerous obstacle in dry or wet roads, loose gravels etc. transmits an excessive brake force to the wheels. This excessive force may cause the wheels to stop spinning and leads to lose of road grip. With no firm contact between the tire's contact patch and the road surface, the bike becomes unstable and a crash is imminent.

The slipping wheels on a riding surface results in losing control of whole motorcycle which usually occurs in fractions of a second. Restoring traction while keeping the bike balanced is only a result of luck, or extreme training, as is the case of professional stunt riders who drift. Preventing the wheels from slipping due to excessive braking force compensates losing control and help the rider to maneuver the vehicle and to avoid accidents.

So what the ABS does is actually limiting the braking force exerted by the rider by either squeezing the lever and keep the wheel spinning. Once the imminence of the locking (and therefore skidding) is avoided, the system re-applies the maximum braking force until the next skid is anticipated. By limiting the max force of the braking maneuver, the ABS systems practically allow the riders to use the greatest stopping force possible without locking the wheels.

How does the ABS understands the wheel locking?

The ABS uses continuous wheel speed monitoring system; wheel speed sensors and toner rings and a Hydraulic Electronic Control Unit (HECU).

During normal operation the ABS works similar to a normal brake. The speed sensors fitted on the both the wheels (in case of dual channel ABS) measures the rotational speed of the wheels, when the wheel speed reduces rapidly i.e. wheels tends to lock, the HECU modulates the pressure in the brake circuit and thereby prevents the wheels from locking.

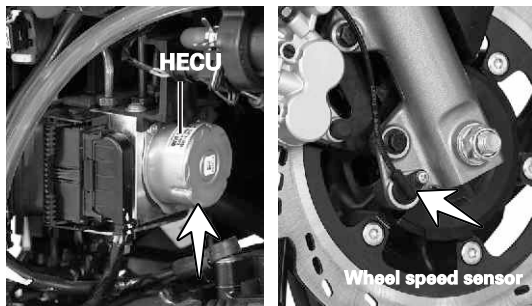

How the irregular road surface affects the braking?

Humps and irregular surfaces of the road can cause the wheels to lose contact temporarily with the road surface; if this happens the braking force that can be transmitted to road surface is zero.

If the brakes are applied under these condition, the ABS has to reduce the braking force to ensure and maintain the directional stability when the wheels regains its contact with the road surface. At this instant the ABS must reduce the traction, so that the wheels will continue to rotate under all imaginable circumstances, because this is the precondition for ensuring directional stability.

As soon as the actual circumstances arises, the system reacts instantly and adjusts braking force accordingly to achieve optimum braking.

Why does brake pedal / lever pulsate during brake application?

Vehicles fitted with ABS uses the conventional brake system during normal operation. **But during hard stop the brake pedal / lever feels different, i.e., a rapid pulsation in the brake pedal / lever; This is absolutely normal.**

It is not necessary to have this pulsation feel every time the brake is applied. Pulsations are felt only during wheel locking tendency, occurs due to the modulation of pressure in the brake circuit by HECU. Pulsation means that the vehicle is in limit. This pulsation feel also depends on the road condition.

Rear wheel lift

Under very severe and sudden deceleration, however, under certain circumstances it is possible that the ABS unit fitted in your vehicle will be unable to prevent the rear wheel from lifting clear of the ground and flip over. Severe braking can cause the rear wheel to lift off the ground.

ANTI-LOCK BRAKING SYSTEM

When you brake, bear in mind that ABS control cannot always be relied on to prevent the rear wheel from lifting clear of ground.

Warning

The ABS can apply and release the pressure in the brake circuit much faster than that rider can do with brake lever / pedal to avoid wheel locking. So there is no need to pump the brake, it requires only continuous application.

Incase of single channel ABS system, only the front brake of your motorcycle is fitted with ABS system and not the rear brake. Applying rear brake alone can cause wheel skidding just like normal braking system incase of single channel ABS system. Always apply both front and rear brake for better performance.

ABS warning lamp

The TVS Apache RTR 200 Fi 4V does an automatic self check every time when the ignition switch is turned 'ON'. The ABS warning lamp provided at the speedometer console blinks and informs you that the ABS is under check.

TVS 

This ABS warning lamp goes 'OFF' once the bike reaches 10 km/h speed and above incase of dual channel vehicles or 7 km/h speed and above incase of single channel vehicles and blinks whenever the bike speed is less than 6 km/h speed (only in single channel vehicles) indicating that the ABS is working fine.

If the warning lamp glows continuously even after the bike crossing the specified speed limits, then the ABS has an error and your bike should be taken to any of our nearest TVS Motor Company Distributor, Dealers and Authorised Service Centers.



DO'S AND DON'T'S

Do's

- Check the ABS warning lamp for any warning before driving the vehicle.
- Apply both front and rear brake for better performance.
- Apply continuous brake in ABS mode for better performance. Do not pump.
- Perform the periodic maintenance as per the schedule.
- ABS should be serviced only at TVS Motor Company Distributor, Dealers and Authorised Service centers.
- Carefully remove the wheel during puncture / tyre replacement to prevent toner ring damage / bend.
- **Keep the wheel in such a way that the toner ring is facing upwards.**
- Always use recommended brake fluid. Use fresh, clean brake fluid.
- Use only the recommended make, type and size of tyre (ABS tuned with tyre specified by the TVS Motor Company).

Don't's

- Do not use non-standard tyres.
- Do not pump the brakes. Apply the brakes continuously.
- Do not ignore any warning lamp on speedometer.
- Do not adjust the wheel speed sensor air gap your self.
- Do not run the engine and ride or rotate the rear wheel alone in gear with vehicle on centre stand, for drive chain lubrication, during water wash etc.,
- Do not attempt to correct the toner ring teeth by bending manually or by using any other method.

Warning

ABS only helps in improving the vehicle control. It is always good to remember not to exceed the physical limits of the vehicle stability. It is rider's responsibility to ride at a suitable speed, while taking care of conditions and road surface. ABS will not compensate for errors in the judgement or improper brake use in the various situation. ABS never eliminates the danger of falling while turning.

Hard braking during sharp cornering on slippery surface may lead to vehicle instability. Under such circumstances gradual braking is recommended.

- Do not use different toner ring.
- Do not insert any metallic parts near wheel speed sensor.
- Do not test the ABS on road!!, but use ABS (it is already tested).

Note

Incase of ABS failure, the braking system will work like a non ABS braking system and provides normal stopping distance.

This motorcycle is equipped with ABS and tubeless tyres. For repair or replacement please contact nearest TVS Motor Company Distributor, Dealers / Authorised Service Centers.

As a general riding practice it is advisable to apply more front brake and less of rear brake.

Never open HECU on your own, it is a very sensitive part of ABS and needs to be handled only by the trained personnel. Contact your nearest TVS Motor Company Distributor, Dealers / Authorised Service Centers.

Use of non-genuine brake pads, tyres, disc etc. leads to poor braking performance and unsafe riding conditions

- **Do not use non-genuine spares like pads, discs, tyres etc.**
- Do not try to service HECU or open to separate parts.
- Do not disengage the ABS by removing the ABS coupler.

Warning

Do not ride the vehicle in conditions like wheelie, stoppie, on-stand engine revving in gear for chain lubrication and during water wash etc... for more than three minutes as it will result in ABS error and ABS warning lamp glowing continuously. In such cases, just switch 'OFF' and switch 'ON' the ignition key once. ABS warning lamp may glow continuously if any ABS error had occurred before.

This error gets cleared automatically and ABS warning lamp goes 'OFF' after riding the vehicle above 10 km/h speed. If the ABS warning lamp is still 'ON', then contact the nearest TVS Motor Company Distributor, Dealers / Authorised Service Center **(applicable only for dual channel ABS system)**.

SAFE RIDING RECOMMENDATIONS

Any two wheeler riding requires some precautions to be taken to ensure the safety of the rider, pillion rider and other road users. These precautions are:

Familiarise yourself with new TVS Apache RTR 200 Fi 4V

Riding skill and your mechanical knowledge forms the foundation of safe riding practices. We suggest you to practice riding TVS Apache RTR 200 Fi 4V in a low-traffic condition until you are thoroughly familiar with your vehicle and its controls. Remember practice makes you perfect.

Riding apparel

Loose, fancy clothing can be uncomfortable and unsafe when riding a two-wheeler. Choose good quality two wheeler riding apparel.

Know your limits

Ride within the boundaries of your own skill at all times. Knowing these limits and staying within them will help you avoid accidents.

Warning

Two wheeler safety starts with wearing a good quality helmet. One of the most serious injuries that can happen is a head injury. Always wear an ISI approved helmet that should fit your head comfortably and securely. You should also have good quality goggles to protect your eyes and help your vision.

To prevent or minimize accident, never consume alcohol or drugs before or during the operation of your vehicle. Even minimal consumption of these will affect the rider's ability to control the vehicle.

Posture

Proper vehicle riding starts with proper posture.

1. Keep your elbows relaxed and flexible.
2. Sit and adjust yourself on seat so that arms and shoulders are relaxed.
3. Look widely instead of gazing at one point.
4. Keep the knees close to the fuel tank.

Warning

One-hand riding is dangerous. Keep both hands firmly on the handle bar and both feet securely on the foot rest. Under no circumstances should both the hands be removed from the handle bar, as it is very dangerous.

Avoid use of mobile phones while riding as it could lead to fatal accident.

Do not downshift the gears in the midst of cornering. Slow down to a safe speed before negotiating a corner. If this is the first time that you are riding a vehicle of this type, we suggest that you practice on a safe, open area to thoroughly familiarise with the operation of the vehicle.

Cornering

When cornering, centrifugal force works in a direction perpendicular to the direction in which the vehicle is moving. Centrifugal force increases in proportion with speed and the radius of the corner.

During cornering, reduce speed so as to reduce the effects of centrifugal force. Avoid abrupt application of brake or sudden steering by all means.

Braking

For safe riding, it is very important to master the braking techniques.

1. Close/release the throttle.
2. Hold the vehicle upright as you apply the brake.
3. Progressive application of brakes is safer.
4. Never declutch while braking at higher speeds.
- 5. Apply both the brakes.**
6. Do not pump the brakes.
7. Riding down hills, while cornering and wet roads close throttle and down shift the gear to take advantage of gearbox and engine which acts as an additional brake. This will avoid the loss of control over the vehicle due to over speed.

Causes for poor braking

1. If the brake shoes / pads or drum / disc are worn out or if there is water or oil on them, sufficient friction does not develop and brakes do not work well.
2. Even when the brake works normally, if the road surface is wet or the tyre surface is worn-out, tyres do not take a firm hold on the surface, increasing the stopping distance.

Warning

As the vehicle speed increases, the stopping distance also increases progressively. Be sure that, you have sufficient distance between you and the vehicle or obstruction ahead of you. Avoid directing the water jet directly towards brake drum / disc pads during water wash.

Using only the front or rear brake is dangerous and can cause skidding and loss of control. **Apply both the brakes together and with great care on a wet road or other slippery surfaces.**

Any abrupt braking on slippery or irregular roads can cause loss of rider control.

3. Approximately 60% braking effect is from front brake. **Non-usage of front brake causes poor braking.**

ACCESSORY INSTALLATION AND SAFETY TIPS

Use extreme caution while selecting and installing the accessories for your motorcycle.

The addition of **unsuitable accessories can lead to unsafe operating conditions.** Your friendly Dealer will assist you in selecting quality accessories and installing them correctly.

While selecting the accessories, make sure the accessories **should not obstruct lighting, steering, suspension level and ground clearance.** Please ensure that if the tank cover is used, it is not getting en-trapped between fuel tank and fuel tank cap.

Additional electrical equipments and controls should not exceed the specified electrical system load of the vehicle (capacity of battery and magneto).

EMISSION CONTROL

All the TVS vehicles are tested in the factory for optimum fuel efficiency and CO levels. If the vehicle needs any adjustments, please consult nearest TVS Motor Company Distributor or Dealers / Authorised Service Center.

While adequate care is exercised at the factory to ensure that the emissions are within the limits, it is essential for the owner to always maintain the motorcycle in good condition by getting it periodically checked and serviced by TVS Motor Company Distributor or Dealers / Authorised Service Center so that the emission and fuel consumption levels are maintained as per norms.

Crankcase emission control system

The engine of new TVS Apache RTR 200 Fi 4V is equipped with a closed crankcase system to prevent discharging crankcase emissions into the atmosphere. Blow-by gas is returned to the combustion chamber through the air cleaner and the fuel system.

Evaporative Emission Control System

The TVS Apache RTR 200 Fi 4V is equipped with an evaporative emission control system which consists of a canister and associated piping. This system prevents the escape of fuel vapors from the fuel tank.

Warning

If there is any abnormal jerk, startability issue are felt in the vehicle or noise due to sudden escape of gas during opening of fuel tank cap, immediately report to the TVS Motor Company Distributor or Dealers / Authorised Service Center.

Note

Your vehicle is tested and certified for emission which meets BS VI emission norms and is valid for initial 12 months from the date of purchase. Get your vehicle certified by the Government authorised emission testing station every year (after initial 12 months of usage).

VEHICLE IDENTIFICATION NUMBER

The frame and engine serial numbers are the only means of identifying your vehicle from others of the same model and type. They are also required to assist your Dealer for ordering parts or referring to special information.

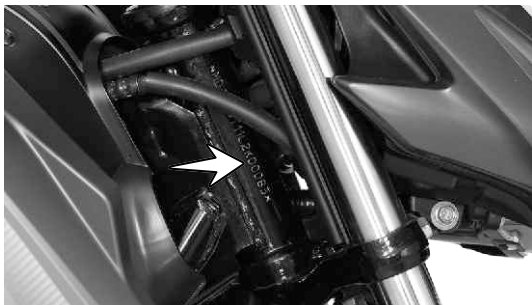

Frame serial number is engraved on the right side of the steering head tube as shown in the above figure.

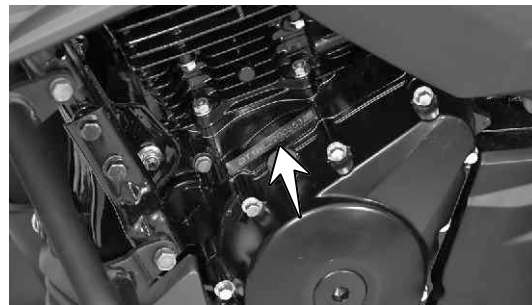

Engine serial number is engraved on the left side crankcase assembly near cylinder block as shown in the above figure.

Frame number

| | | | | | | | | | | | | | | | | | | | |
|--|--|--|--|--|--|--|--|--|--|--|--|--|--|--|--|--|--|--|--|
| | | | | | | | | | | | | | | | | | | | |
|--|--|--|--|--|--|--|--|--|--|--|--|--|--|--|--|--|--|--|--|

Engine number

| | | | | | | | | | | | | | | | | | | | |
|--|--|--|--|--|--|--|--|--|--|--|--|--|--|--|--|--|--|--|--|
| | | | | | | | | | | | | | | | | | | | |
|--|--|--|--|--|--|--|--|--|--|--|--|--|--|--|--|--|--|--|--|

Control key number

| | | | | | | | | | | | | | | | | | | | |
|--|--|--|--|--|--|--|--|--|--|--|--|--|--|--|--|--|--|--|--|
| | | | | | | | | | | | | | | | | | | | |
|--|--|--|--|--|--|--|--|--|--|--|--|--|--|--|--|--|--|--|--|

Please fill the above boxes now for future reference



LOCATION OF PARTS - HANDLE BAR

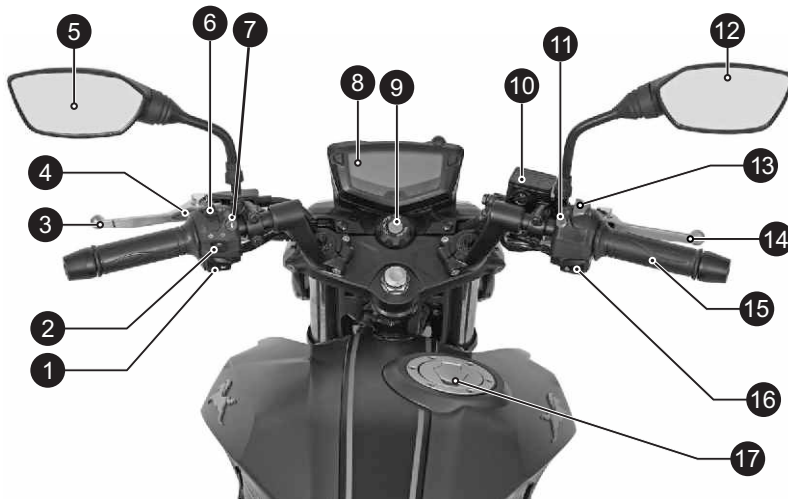

1. Horn switch
2. Turn signal lamp switch
3. Clutch lever
4. Pass by switch
5. Rear view mirror L
6. High / low beam switch
7. Info switch
8. Connected instrument cluster
9. Ignition cum steering lock
10. Master cylinder (front)
11. Mode switch
12. Rear view mirror R
13. Engine cut off switch
14. Front brake lever
15. Throttle grip
16. Electric starter switch
17. Fuel tank cap



LOCATION OF PARTS - VEHICLE LEFT SIDE



1. Front wheel axle
2. Gear shift lever
3. Centre stand
4. Side stand
5. Rider foot rest L
6. Pillion foot rest L
7. Rear wheel axle
8. Saree guard
9. Wheel hugger
10. Cover frame L

LOCATION OF PARTS - VEHICLE RIGHT SIDE



1. Disc plate front
2. Toner ring front
3. Front wheel axle nut
4. Wheel speed sensor front
5. Caliper assembly front
6. Spark plug
7. Gauge oil level
8. Rear brake pedal
9. Rider foot rest R
10. Pillion foot rest R
11. Muffler assembly
12. Disc plate rear
13. Wheel speed sensor rear
14. Rear wheel axle nut
15. Caliper assembly rear
16. Location of ram air duct
17. Cover frame R



LOCATION OF PARTS - VEHICLE FRONT AND REAR

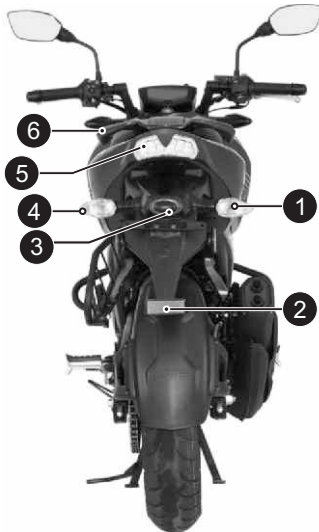

FRONT

1. Turn signal lamp front L
2. Head lamp assembly
3. Oil cooler
4. Crash guard
5. Turn signal lamp front R
6. Position lamps

REAR

1. Turn signal lamp rear R
2. Reflex reflector
3. Number plate lamp
4. Turn signal lamp rear L
5. Tail lamp assembly
6. Pillion handle

CONTROL KEY

Your TVS Apache RTR 200 Fi4V comes with a pair of identical control keys. These keys are to operate ignition cum steering lock, fuel tank cap and seat lock.

IGNITION CUM STEERING LOCK

The ignition switch enables and disables the electrical circuit and steering lock. The three positions of the switch are described below.

1. 'OFF' position

All electrical circuits are deactivated. The key can be removed from the lock.

2. 'ON' position

All electrical circuits are activated. The instrument cluster and warning lights perform the self-diagnostic cycle once upon activation. The engine can be started. The key cannot be taken out from the lock.

i Note

When the ignition is turned ON with the engine kill switch ON condition, priming noise of pump may be heard which is absolutely normal.

Frequent switch 'OFF & ON' of ignition to be avoided. After ignition key reset, there may be a delay in start of vehicle for couple of seconds.



3. 'LOCK' position

Your TVS Apache RTR 200 Fi 4V steering can be locked in both 'left' and 'right' directions.

Turn the handlebar to the extreme 'left' or 'right'. Press the key in and rotate it to the 'LOCK' position from 'OFF' position. All electrical circuits are deactivated and the steering is locked. The key can be removed from the lock.

Insert the key into the lock and turn it to 'OFF' or 'ON' position to unlock the steering.

Warning

Never attempt to move the vehicle when the steering is locked, you may lose balance.

Caution

Leaving the ignition cum steering lock in 'ON' position for a prolonged time will drain the battery when the vehicle is not in use. Switch OFF and take the key out when the vehicle is not in use. Always lock the steering while parking for safety.

Note

Connected instrument cluster's background illumination, position lamps, headlamp low beam, tail lamp and number plate lamp glow automatically once the ignition is turned 'ON' without activating any other switch.

When the ignition switch is turned 'ON' the connected instrument cluster performs self diagnostic cycle. A message 'GEAR UP' followed by a 'Race flag', 'Welcome message', 'Ride mode name' and 'Average speed details' will be displayed on the cluster's display. Wait till the 'AVG. SPEED' details appears on the display.

HANDLE BAR LIFT SIDE



1. Info switch

Info switch '' is used to cancel an incoming call, clear notification on cluster display, start / stop of LAP in lap timer mode, accept / reject the nearest fuel location suggestion.

2. Horn switch

Press the switch () to blow horn. It is used to attract the attention of other road users in case of danger.

3. Turn signal lamp switch

When the turn signal switch is moved to left '' or right '', the corresponding turn signal lamps flashes. To stop flashing, push the switch in.



Warning

Failure to switch the turn signal lamp 'ON' or 'OFF' at the right time may lead to an accident.

4. Adjustable clutch lever

Press the lever towards grip to disengage the drive. It is used to disengage the clutch while shifting the gears.

Note

Clutch lever can be set to your convenience. Refer page no. 56

5. Pass-by switch

Press the switch to flash the head lamp. It is used to give signal to the vehicles coming from the opposite direction while overtaking other vehicles during day.

The head lamp glows automatically once the engine is started. If the head lamp is glowing in 'Low' beam, on pressing the switch, the head lamp 'High' beam also glows along with the 'Low' beam.



If the head lamp is already glowing in 'High' beam, the pass-by system will not work.

Note

Pass by system will not work if the head lamp is glowing in 'High' beam.

6. Head lamp high / low beam switch

The head lamp low beam glows automatically. Only the head lamp beam (high/low) can be controlled with the beam control switch.

Press the top end of switch for 'High' beam '  ' and bottom end for 'Low' beam '  '.

Low beam of the vehicle is turned on with Ignition key ON and high beam is activated once the engine is started and switch is in High beam position.

Warning

Use appropriate head lamp beam 'high / low' as per the traffic and road conditions for your safety and to avoid inconvenience to other riders.

It is strongly recommended to ride the vehicle in 'low' beam during day.

Note

Only the engine is started the head lamp high beam glows, provided if the beam control switch is in high beam.

HANDLE BAR RIGHT SIDE

1. Electric starter switch

Ensure the transmission is in neutral or else press the clutch lever before engaging the electric starter switch '⚡'.

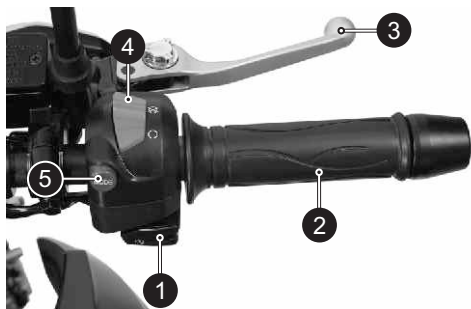

i Note

Ensure to turn ON the engine cut-off switch before starting the vehicle.

Release the electric starter switch immediately after pressing.

2. Throttle grip

It controls the fuel-air mixture supplied to the engine, which regulates the engine speed. Rotate the throttle grip in counter-clockwise from its idle position to increase the engine speed and vice-versa to reduce.

3. Adjustable front brake lever

It controls a hydraulic circuit (ABS) that operates the front brake system. The front brake is applied by pressing the front brake lever gently towards the grip. The brake lamp glows on application of front brake.

i Note

Front brake lever can be set to your convenience. Refer page no. 56

4. Engine cut off switch

It is '⊗' used to switch off the engine but to keep other DC system active. The ignition circuit is disabled, preventing the engine from being restarted. To restart the engine, return the switch to the '⊙' position.

i Note

With the ignition switch ON and engine kill is turned ON/ OFF, priming noise of fuel pump may be heard which is absolutely normal.

i Note

Frequent switch 'OFF' & 'ON' of ignition to be avoided to prevent unnecessary run of fuel pump.

5. Mode switch

Press the mode switch to switch between Urban, Rain and Sport modes. (refer page no. 28 for further details)

GEAR SHIFT LEVER

TVS Apache RTR 200 Fi 4V is equipped with a 5 speed constant mesh transmission. Neutral (N) position of the transmission is indicated by the warning light on the speedometer.



To shift the transmission from neutral to first gear, push the gear shift lever down.

To change it to the second gear, lift the lever up. Lifting the lever up repeatedly engages all the gears in succession up to the fifth gear.

The gear shift indicator on the speedometer dial indicates the current gear position.



Caution

Never shift gears without disengaging the clutch and releasing the throttle. Failure to comply this will lead to rough shift or jerk while shifting the gears. Remember to return to neutral position before restarting the engine.



Note

Gear shift lever position can be set to your convenience. Contact your TVS Motor Company Distributor or Dealers / Authorised Service Center for setting the gear shift lever position.



REAR BRAKE PEDAL

The rear brake pedal operates a hydraulic circuit (ABS circuit in case of Dual channel ABS) that operates the rear brake system and it is located adjacent to the right side foot rest. To control the speed of your vehicle close the throttle completely, and gradually press the brake pedal down wards.

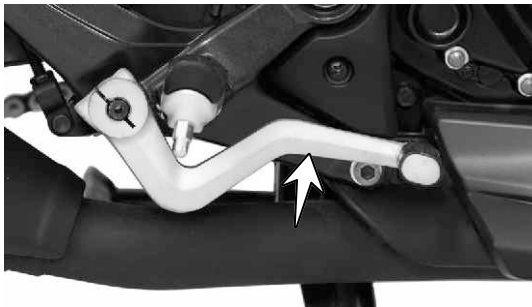

i Note

Rear brake pedal position can be set to your convenience. Contact your TVS Motor Company Distributor or Dealers / Authorised Service Centers for setting the brake pedal position.

! Caution

Independent use of rear or front brake reduces the overall braking efficiency. In extreme conditions braking with only rear or front brake may lock the wheel which would result in skidding or toppling of vehicle.

Braking performance is affected adversely with wet surfaces, loose surfaces and overheating of brake system due to unnecessary continuous application of brakes. For safety, exercise extreme caution while braking and also at turning. Do not accelerate while turning.

CONNECTED INSTRUMENT CLUSTER

Your TVS Apache RTR 200 Fi4V is provided with a fully digital connected instrument cluster with lots of features and various modes, mobile app for 'Smart Phones' and navigation assist etc.

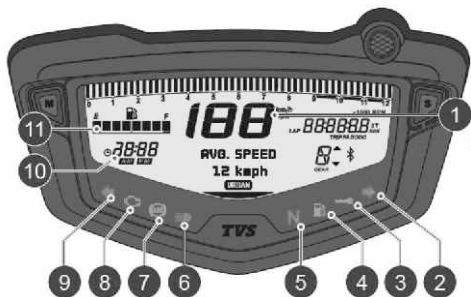

Indicates the vehicle speed in kilometer per hour by default whenever the ignition is turned 'ON'. This can be changed to mile per hour. Change the mode between kilometer per hour and mile per hour using the mode and set switch buttons (refer page No. 33 for changing the speed indication between km/h and mph).

i Note

If you leave the ignition key in 'ON' position and vehicle is kept in gear without moving for more than 3 minutes, an error message 'CHECK SPEED SENSOR' may scroll which is normal.

If you notice an error message 'CHECK SPEED SENSOR' while the vehicle is in move, Contact nearest TVS Motor Company Authorised Main Dealer / Authorised Dealer for rectification.

1. Speedometer



2. Turn signal indicator right (⇒)

Flashes when the 'right' side turn signal indication is activated.

3. Immobilizer indicator (🔒)

-NA-

NA - Not applicable for present model



4. Low fuel indication ()

Blinks when the fuel level reaches to minimum safe fuel level. It glows continuously when the fuel comes below minimum safe level.

5. Neutral indicator lamp (N)

Glowes when the vehicle is in neutral and goes 'OFF' if the gear is shifted from neutral.

6. High beam indicator lamp ()

Glowes when the head lamp is activated in high beam.

7. ABS warning lamp ()

ABS warning lamp blinks when the ignition key is turned 'ON' and speedometer performing self check. This lamp goes 'OFF' once the vehicle reaches 10 km/h speed and above in dual channel vehicle and 6 km/h speed and above in single channel vehicle. If this lamp glows continuously then have your vehicle checked at TVS Motor Company Distributor, Dealers / Authorised Service Centers (refer page No. 04 for more details).

 Note

In single channel vehicle, this ABS warning lamp will blink whenever the vehicle speed is less than 6 km/h which is normal. It also indicates that the ABS is working fine.

8. Malfunction indicator lamp ()

Malfunction indicator lamp (MIL) '  ' is activated whenever the ignition is turned ON, till the engine is started. It will go OFF once the engine is started.

If this lamp glows continuously even after starting the engine, it indicates that there may be an error in the system. **Immediately contact the nearest TVS Motor Company Distributor, Dealers / Authorised Service Centers.**

9. Turn signal indicator left ()

Flashes when the 'left' side turn signal indication is activated.

10. Digital clock

Indicates the time in 12 or 24 hour time format as per user's preferred setting. Refer page no. 35 for changing the time format between 12 hour and 24 hour.



 Note

If the battery is disconnected and reconnected during service. You may need to reset the time as explained in page No. 35.

11. Fuel gauge

Digital bars indicates the approximate quantity of fuel available in the fuel tank. There are eight bars to indicate the quantity of fuel available in the fuel tank.



All the eight bars will be displayed when the fuel in the tank reaches above 10.5 liters approximately (full tank). When the fuel reaches half tank (6.5 liters approx.) the fuel gauge displays only four bars as shown.

The fuel gauge shows only single bar when the fuel reaches safe fuel level (3.5 liters approx.)



Caution

Before turning the IGNITION key to ON position, ensure the availability of adequate fuel in the tank. That is LOW FUEL INDICATION shall not come ON, before the start of the vehicle.

To avoid dry run of fuel pump, never run vehicle beyond 5 km, after LOW FUEL INDICATION.



Low fuel indication (serial No. 4) starts blinking when the fuel reaches to the minimum safe level 2.5 liters approximately. Refill the fuel immediately. Once the fuel level reaches 1.8 liters approximately, no bar will be visible and low fuel indication (serial No. 4) glows continuously.



If all the fuel level bars in the cluster are blinking and an error message 'CHECK FUEL SENSOR' blinks at bottom, Contact nearest TVS Motor Company Distributor or Dealers / Authorised Service Centers.



12. Odometer / Trip meter 1 & 2 / Lap indicator / High speed indicator / Shortest time indicator

The procedure for setting each mode is given in page No. 33.

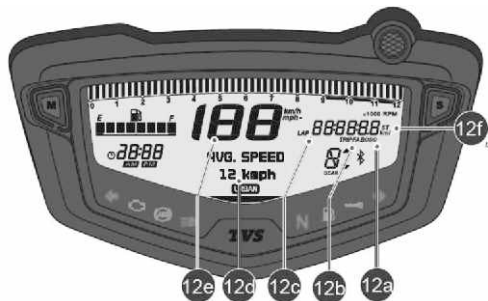

12a.Odometer

Odometer registers the total distance covered by the vehicle in kilometer or mile as per the user's preferred setting. The digit after the dot mark denotes one tenth of a kilometer or mile. Set the meter in 'ODO' mode to know the odometer reading.



12b. Trip meter

Trip meter indicates the trip distance travelled in kilometer or mile (as per the preferred settings). The digit after the dot mark denotes the one tenth of a kilometer or mile.

Provision to measure two different distance 'TRIP 1' or 'TRIP 2' is provided for the users to use as per their convenience.



12c. Lap timer

Lap timer indicates the time taken to complete a particular lap. On entering the lap timer mode, press the 'Info switch ()' on the handle bar to start a lap timer. The timer starts counting current lap's time and displays in active lap timer as shown (before starting the lap timer, ensure that the timer is reset. Refer page No. 34 for details).



Press the 'Info switch' again to stop the current lap timer and to start a new lap. Existing lap timings will be displayed as shown below and continue to get updated whenever a new lap is started and stopped. Long press the 'Info switch' for few seconds (more than 1 second and less than 3 seconds) to stop the lap timer count.

LAP1: 00:00:13**LAP2: 00:00:16**

To start a lap timer again, after stopping it by pressing the 'Info switch', the lap timer need to be reset as explained page No. 34. You can record any number of laps but last three lap's details only will be displayed in the cluster.

 Note

Lap timer works only when the lap timer mode is active. Once the lap timer is stopped by pressing the 'Info switch', the timer cannot be started again until the timer is reset. Only last three lap's timing will be displayed in the cluster on entering the lap timer mode.

12d. Notification area

A general purpose notification area where, ride mode information, error information, service due, connectivity information, warnings are displayed. In this area if the mobile device is not connected, Avg. speed is displayed. If bluetooth device is connected same Avg. speed can be accessed using "SET" button on speedometer.

AVG. SPEED**82 kmph****12e. High speed indicator**

High speed indicator records the maximum speed (top speed) achieved by the rider so far either in km/h or mph as per preferred setting. You can reset and record the new speed if required. Refer page No. 34 for resetting the high speed data. On entering the high speed mode previously achieved high speed data will be displayed in the instrument cluster as shown.

95^{km/h}

Whenever the vehicle speed crosses the previously achieved high speed, a message 'ACHIEVED HIGH SPEED' will be popped-up and a trophy symbol will be flashed to cheer your achievement when the vehicle reaches to a safer low speed.

These pop-ups can be cancelled by pressing the 'Info switch' () on the handle bar else it will disappear automatically.



**ACHIEVED
HIGH SPEED**

 Note

Maximum speed recorded so far will be displayed whenever the meter is set in 'HIGH SPEED MODE'. This display will go off automatically once the vehicle starts moving (>3 km/h) and it will continue the normal operation.

Max speed recorded will be stored until manual reset. If the high speed is reset, the speed value will be shown as '0'.

12f. Shortest time indicator

Shortest time indicator records the minimum time taken so far to reach 60 km/h or 40 mph speed (according to the preferred setting).

On entering the shortest time mode, the overall best time achieved so far will be displayed for few seconds as shown.

0-60 kmph : 9.2s

And the last recorded time will be displayed in the shortest time recorder as given below.

9.6ST

This last recorded time can be reset as explained in page No. 34 and a new time can be recorded if required. The overall best time will be replaced automatically by the next overall best time. On achieving the new overall best time, a message 'ACHIEVED SHORTEST TIME' will be popped-up and a trophy symbol will be flashed to cheer your achievement when the vehicle reaches to a safer low speed.



ACHIEVED SHORTEST TIME

These pop-ups can be cancelled by pressing the 'Info switch' () on the handle bar else it will disappear automatically.

Note

Overall best time achieved so far and the last recorded time to reach 60 km/h or 40 mph speed will be displayed when the ignition is turned 'ON' and the meter is set in 'SHORTEST TIME MODE'.

For recording a new time, the last recorded shortest time need to be reset. On resetting time, the value will be reset to 0.0 (but the default value is 9.9 secs.). Overall best time recorded cannot be reset manually. It will be replaced automatically by next overall best time.

Once the speed reached 60 km/h or 40 mph, then the time will stop at the exact point.

13. Ride Modes

TVS Apache RTR 200 Fi 4V has three different ride modes, select the desired ride modes by press the mode switch in right hand switch assembly. (refer page no. 19)

The modes are explained in the following pages in the below sequence .

13a. URBAN

13b. SPORT

13c. RAIN

The preferences of mode usage are: Sport mode especially on race tracks and dry roads, Urban mode especially in city on all types of roads and Rain mode especially on wet roads.

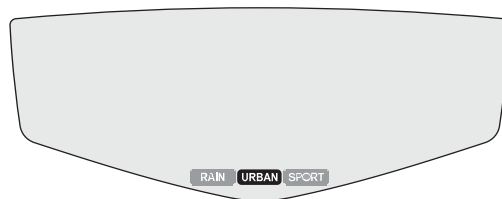

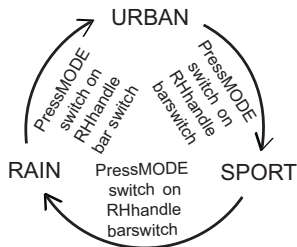

13a. URBAN

In Urban mode the engine and ABS braking system is modified to suit city on all types of roads riding condition. The max speed is limited to 105 Km/h and the ABS braking is optimized.

URBAN

13b. SPORT

In Sport mode the engine and ABS braking system is modified to suit highway riding condition. The vehicle max speed in sport mode is 127km/h and the ABS braking will be aggressive with late ABS intervention however, basic safety is ensured.

SPORT

13c. RAIN

In Rain mode the engine and ABS braking system is modified to suit wet or rainy condition. The max speed is limited to 105 Km/h and the ABS intervention is earlier and safe braking will be felt.

RAIN

i Note

Mode changes are allowed only when throttle is closed after a mode change request. To guide for the same, "CLOSE THROTTLE" pop up will be displayed in notification area.

**CLOSE
THROTTLE**

! Caution

In case any fault is detected with respect to the ride mode change in the EMS or ABS system, then your motorcycle will operate only in the Urban mode after ignition key reset.

i Note

If conditions for mode change are not successful 'MODE CHANGE ERROR' appears on display.

MODE CHANGE ERROR

At the end of self-check active ride mode information will be displayed on the LCD segment

- 14. Shift RPM indicator / 15. Tachometer / 16. Trip F / 17. Gear shift indicator / 18. Service reminder / 19. Low battery indication**

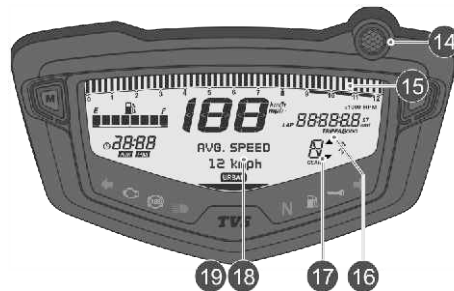

14. Shift RPM indicator

Shift RPM indicator alerts the user to up shift or down shift the gears when engine reaches the specified RPM based on the ride modes. The red indicator in the digital speedometer glows and indicates the user to shift to next higher gear or lowest gear.



UP SHIFT



DOWN SHIFT

i Note

Gear shifting suggestion changes in different vehicle operating mode.

Shift RPM indicator does not work when the vehicle is in neutral and upshift does not work when the fifth gear is engaged.

15. Tachometer

Tachometer indicates the engine speed in multiples of 1000 RPM (Revolutions Per Minute).

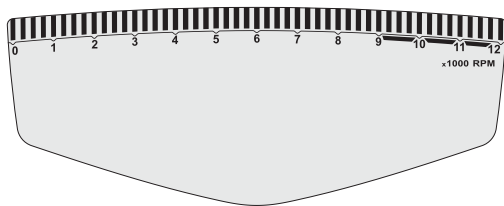

16. Trip F

This function shows the distance travelled when the low fuel indication symbol () starts blinking and fuel gauge shows no bar or glows continuously with fuel gauge showing no segment, the display automatically switches to the 'TRIP F' indicator after 0.5 km or 0.3 miles as per preferred settings and 'TRIP F' meter starts counting from 0 km in km/h mode and 0 miles in mph mode.

If the fuel level remains in minimum safe level, the reading is saved even after the ignition key is turned 'OFF'.

The count stops and clears automatically after a certain distance covered when the fuel level rises above minimum safe level. 'TRIP F' meter cannot be activated or deactivated manually.

At every ignition ON, 'TRIP F' meter will get enabled automatically until fuel level is reached above minimum safe level (2.5 L).



120 km
TRIP F

17. Gear shift indicator

The gear shift indicator in the digital display indicates the position of the gears.



i Note

If you notice an error message 'CHECK GEAR SENSOR', Contact nearest TVS Motor Company Distributor or Dealers / Authorised Service Centers for rectification.

18. Service reminder

If the service is due, whenever the ignition lock is turned 'ON', the following message will be popped-up after the speedometer's self diagnostic cycle and continues to pop-up till the vehicle is serviced and the reminder is reset. Get the vehicle serviced at TVS Motor Company Distributor or Dealers / Authorised Service Centers.



**SERVICE
DUE**

i Note

Service reminder works only based on the distance (km/ miles) covered by the vehicle. This is only a reminder indicator. Customers are advised to keep track and follow the service schedule.

19. Low battery indicator

The following message will be popped-up after the speedometer's self diagnostic cycle when the battery charge is too low. Get the battery checked at TVS Motor Company Distributor or Dealers / Authorised Service Centers.



**BATTERY
LOW**

i Note

*Service reminder and battery low pop-ups can be cancelled by pressing the 'Info switch' (**i**) on the handle bar.*



MODE AND SET BUTTONS

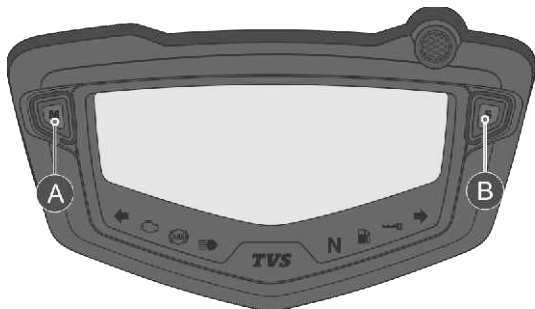

The Mode (A) and Set (B) buttons are provided to change between various modes and to set some of the digital display functions of the instrument cluster. The sequence of modes and their selections are explained in detail below.

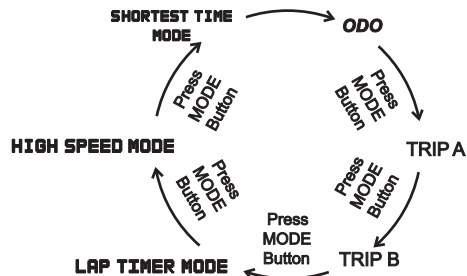

Short press the Mode button to access the following modes:

1. ODO
2. TRIP A
3. TRIP B
4. LAP TIMER
5. HIGH SPEED INDICATOR
6. SHORTEST TIME INDICATOR

i Note

Above mode changes are possible only when the vehicle is in static condition for safety.

On long pressing the Mode button, the following modes can be accessed.

1. SET mph MODE / SET km/h MODE
2. CLOCK SETTING MODE
3. BLUETOOTH PAIRING MODE

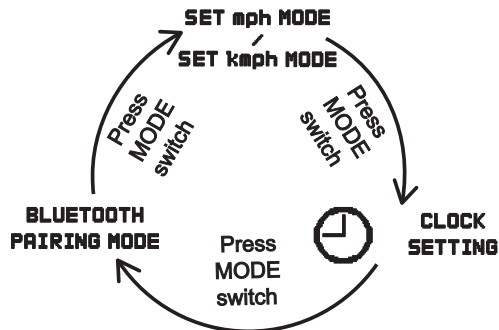

Setting the digital display

Every press of the Mode button changes the display to other mode. Follow the below procedures to change the display to desired mode.

If ignition is turned 'OFF' when the meter is in 'ODO' or 'TRIP' meters, then the respective meters will be displayed in the next ignition 'ON'. If any other modes other than these were set during ignition 'OFF', then 'ODO' meter will be displayed in the next ignition 'ON'.

1. In 'ODO' mode, press the Mode button once and twice to enter '**TRIP A**' and '**TRIP B**' meters respectively.
 - To reset any of the trip meter while ensuring the display is in 'TRIP A' or 'TRIP B', press and hold the Set button for a few seconds.
2. In 'TRIP B' meter mode, press the Mode button once to enter lap timer mode. On entering the lap timer mode, a message '**LAP TIMER MODE**' and last three laps timing will be displayed in the cluster's display.
 - To reset the timings, keep the display in 'LAP TIMER MODE' and wait till the cluster displays the lap timings. Now press and hold the Set button for a few seconds.



3. In 'TRIP B' meter mode, press the Mode button twice to enter high speed mode. On entering this mode, a message '**HIGH SPEED MODE**' and last achieved high speed data will be displayed in the cluster's display.
 - To reset the high speed recorded, keep the display in 'HIGH SPEED MODE', press and hold the Set button for few a seconds.

4. In 'TRIP B' meter mode, press the Mode button thrice to enter shortest time mode. On entering this mode, last achieved shortest time '**9.6st**' and overall best time '0-60 kmph : 9.2s' will be displayed in the cluster's display.
 - To reset the last achieved shortest time, keep the display in 'SHORTEST TIME MODE', press and hold the Set button for few a seconds. Please remember only last / current record will be reset and best time display will remain same until new best time is achieved.

5. Press the Mode button once to change the display to 'ODO' mode again.

MPH and Km/h setting

1. Ensure the display is in 'ODO' mode.
2. Press and hold the Mode button for few seconds till the display enters '**SET mph MODE**'. Press the Set button to select the MPH mode.
3. To change the display to Km/h mode again, press and hold the Mode button till the display enters '**SET kmph MODE**'. Press Set button to select the Km/h mode.

Digital clock setting

1. Ensure the display is in 'ODO' mode.
2. Press and hold the Mode button for few seconds till the display enters 'SET mph MODE' or 'SET km/h MODE' (based on preferred setting).
3. Release and short press the Mode button once again so that the display enters ' **CLOCK SETTING**' mode.

Note

If the display is set to MPH mode, it will switch to Km/h mode by default whenever the ignition is turned 'OFF' and 'ON'.

4. On pressing the Set button, if the clock is in 12 hours format, the hour format 'AM' or 'PM' blinks. Else the clock will be ready for 24 hours format selection.
5. Press the Mode button to change the hour format 'AM' or 'PM' or to change the clock to 24 hours format.
6. If the clock is in 24 hours format press the Mode button once again to set the clock to 12 hours format.
7. Press the Set button again so that the hours digit of the clock blinks.
8. Now, press the Mode button to increase the hours while hour digits are blinking.
9. On pressing the Set button again the hours of the clock is set and the minute digit blinks.
10. Now, press the Mode button to increase the minutes while minute digits are blinking.
11. Press the Set button again to set minutes and to come out from clock setting.

Bluetooth pairing mode ' '

Using the Bluetooth pairing mode the connected instrument cluster of 'TVS Apache RTR 200 4V' can be connected to your Android™ smart phones and iPhone® via Bluetooth® through a TVS CONNECT app which can be download from Google Play and the Apple store®.



TVS CONNECT

Note

If the Set button is pressed when the instrument cluster is in normal operating mode like 'ODO', 'TRIP' etc. following information will be popping out which is not applicable to present model.

NEXT SERVICE

--- --- ---



i Note

Maximum of 3 devices of Android phones can be auto-paired with the instrument cluster.

Only one iPhone can be auto-paired with a single instrument cluster at a time. If the user need to connect multiple iPhones with the single instrument cluster, the previous connected iPhone has to be forgotten by clicking, "Forget This Device" from Bluetooth settings in the iPhone.

If the vehicle battery is reset or fuse is blown, then too "Forget This Device" from Bluetooth settings in the iPhone has to be done.

Steps to "Forget This Device" in iPhone:

If the user needs to connect multiple iPhones with the single instrument cluster, the previous iPhone has to be forgotten using "Forget This Device" from Bluetooth settings in the following manner:

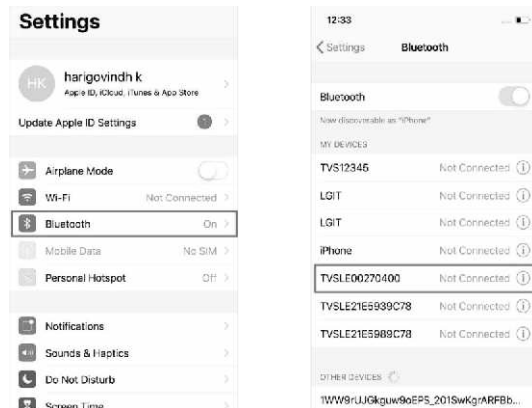

1. In the previous connected iPhone, open the SETTINGS->BLUETOOTH.
2. Select the instrument cluster, which was connected previously.
3. Click on the "Forget this device"



First time Bluetooth pairing:

To pair your Android smart phone or iPhone with your TVS Apache RTR 200 Fi4V motorcycle's connected instrument cluster, via Bluetooth, for the first time, follow the procedure as described below:

1. Ensure the display of the instrument cluster is in 'ODO' mode.
2. Press and hold the Mode button for few seconds till the display enters 'SET mph MODE' or 'SET km/h MODE' (based on preferred setting).
3. Release and press the Mode button two times so that the display enters ' **BLUETOOTH** '.

PAIRING MODE

4. Now, press the Set button to establish the connection with your smart phone.
5. On pressing the Set button the connected instrument cluster checks for the near by available smart phone and displays following message:

**NO DEVICE
CONNECTED**

Now, just press the 'Connect icon' of the mobile app to establish the connection with the cluster.



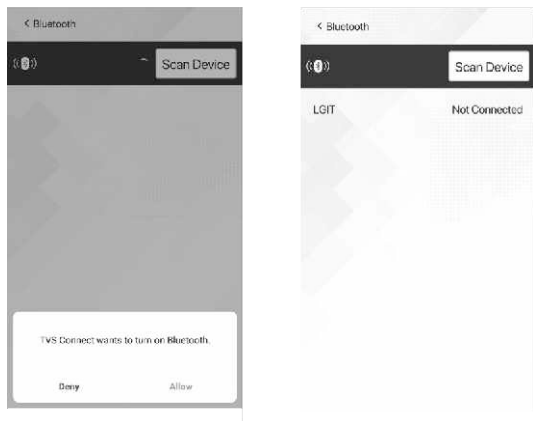

On pressing this icon, the app opens a screen where you will be asked to grant permission to turn 'ON' your smart phone's Bluetooth if it is in 'OFF' condition. Turn 'ON' the Bluetooth. Else, press the 'Scan Device' icon (A) to initiate the search in case the app is not searching automatically. The app searches and lists the available clusters. Just select the listed cluster. The app communicates with the cluster and the cluster generates a pass key.

Enter this pass key in the app screen to complete the connection.

ENTER PASS KEY
123456

i Note

For the first time pairing, the connected instrument cluster should be in 'BLUETOOTH PAIRING MODE'.

During the course of pairing process, there is any occurrence of error, the connected instrument cluster should be turned 'OFF' and 'ON', and the application also need to be restarted.

Please remember that, all the smart phones are not compatible for pairing with the TVS Apache RTR 200 Fi4V motorcycle's connected instrument cluster.

During the search of Bluetooth devices in app, if the vehicle connected instrument cluster's Bluetooth device ID is not visible, try for one or two more iterations.

If the phone enters battery saver mode, auto-pairing might not happen. It takes maximum of five minutes for auto-pairing and it can happen in vehicle running below 10 km/h speed or engine at idling or engine off condition.

If the pass key entered wrongly then the instrument cluster displays the following message.

**PASS KEY
WRONG**

On connecting with the smart phone successfully, the instrument cluster displays the user name which is fetched from the smart phone as shown.

**CONNECTED TO
SUNIL**

i Note

Auto-pairing happens only if the application is locked in the RAM in multitasking screen of the phone with manufacturer's customised OS (Ex. : MI, Vivo etc.).

In case of Android phones with Android OS version above 8.0 for App to work seamlessly, any battery optimisation setting to be removed in the TVS Connect app and GPS shall be allowed to run in background in high accuracy mode.

Even if your phone's Bluetooth is already paired to other gadgets like smart watch, health band or helmet, the auto-pairing works with your TVS Apache RTR 200 Fi 4V motorcycle's connected instrument cluster.

i Note

In Android and IOS smart phones, if the Bluetooth is 'ON', and if the app is already paired with the cluster, when the user opens the app with the ignition turned 'ON', the app connects automatically with the cluster once the user takes his phone to near by the vehicle. (if the auto connect setting of your smart phone is turned 'ON'). This feature can be disabled if required. Auto connect will only work with the last paired mobile phone.

If the application unfortunately stops due to unfrozen circumstances. Close and reopen the application and do the manual pairing for the first time, then auto-pairing will happen subsequently.





For first time pairing, logout from the app, login again with your login credential and press 'Connect' icon.

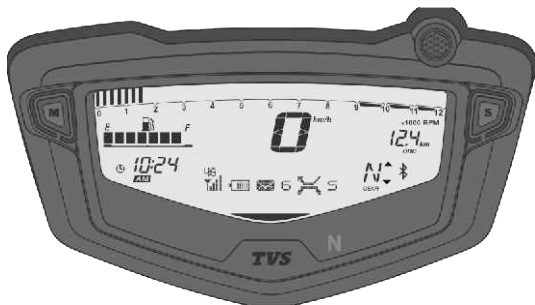

Customer window

This is the default window when the connected instrument cluster of your 'TVS Apache RTR 200 Fi4V' is connected with your smart phone using Bluetooth '  '.



Once the cluster is connected with the smart phone the cluster displays the signal strength of the network provider '  ' and the battery level '  ' of the smart phone. Number of unread messages '  6 ' and number of missed calls '  5 '.

Note

Incase multiple SIM cards are used in smart phone, by default, SIM 1's network provider's signal strength is shown in the display of connected instrument cluster.

Signal strength displayed in connected instrument cluster might vary from the display in smart phone as the former is referred from telephonic standards.

Incoming call alert display ()

The connected instrument cluster will display the incoming calls alerts from the smart phone via Bluetooth. Ex. 'SURESH', will be displayed if the contact is stored in the smart phone otherwise number will be displayed. Ex. '9897712345' (in IOS only "Incoming call" will be displayed).

 SURESH

 +919897712345

Missed call alert display '📞'

The connected instrument cluster displays the total number of missed calls from the smart phone via Bluetooth.

5 MISSED CALLS

SMS alert display '✉️'

The connected instrument cluster displays the incoming SMS from the smart phone via Bluetooth, Ex. 'SMS FROM SURESH', name of the sender will be displayed if it is stored in the smart phone. Else, number will be displayed. Ex. '9897712345' (applicable only for Android smart phones).



»»» SMS FROM SURESH



»»» +919897712345

i Note

Incoming calls, missed calls and SMS alerts can be cancelled by pressing the 'Info switch' (**i**) on the handle bar (in IOS, pressing the switch only clears the notification but the call will not be cancelled in the phone).

Navigation window

Once the navigation assist is turned 'ON', the display of your TVS Apache RTR 200 Fi 4V motorcycle's connected instrument cluster enters into navigation window and displays the turn by turn navigation instruction with a simple and elegant graphical representation.

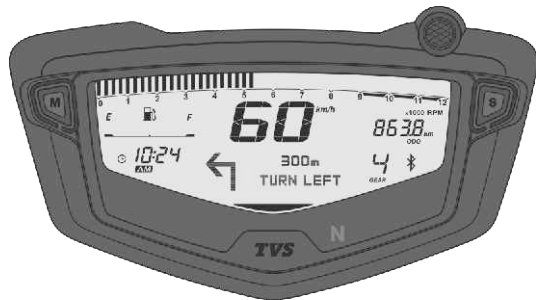

i Note

Please remember that the Navigation License has to be renewed after 5 years of vehicle purchase and renewal can be done by contacting near by Dealer end.

Low fuel alert

When the fuel level in the vehicle reached below reserve level, the app sends a low fuel alert to the connected instrument cluster to give notification of the fuel level. The same alert will be also shown in the app.

Low fuel assist \ Nearest location alert

When the fuel level is low, the app sends a fuel assist message to the instrument cluster. You can either accept or reject the assist request.

If you accept the request (by pressing the 'Info switch' on handle bar for about 3 secs.) the app will automatically provide navigation to the nearest fuel pump.

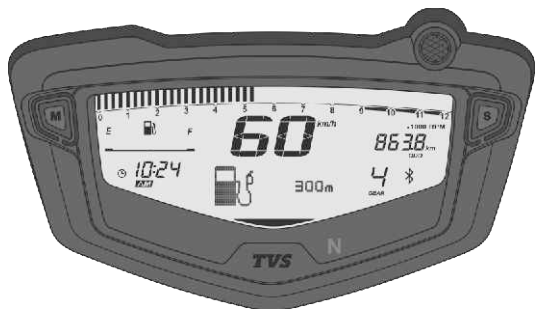

The customer also can chose to reject the request (by pressing the 'Info switch' on the handle bar for about 1 sec.). In which case, the previous display will remain.

Clock auto sync

Whenever the app is connected to the connected instrument cluster the clock of instrument cluster gets synchronised with the clock of the phone.

G-force measurement

G-force measurement provides an approximate G-force measure wherein the vehicle is operated. The G-force is measured during both acceleration and deceleration of the vehicle.

i Note

The G-force is measured based on the vehicle speed and not with an on-board measurement unit. So there might be a variation between the actual and the measured values. The G-force value displayed is only an estimate of the actual value.

Caution

The value of G-Force is indicated in application to understand the braking force applied or driving behavior of rider. we recommend customer to drive safe and keep sufficient distance with respect to vehicle at front and also to drive within the recommended safe limit of driving.

TVS CONNECT APP



Dedicated smart phone app is available in the Google Play and the Apple store for your 'TVS Apache RTR 200 Fi 4V' and it can be installed in your Android smart phones and iPhones. To access the features of your TVS Apache RTR 200 Fi 4V's connected instrument cluster like:

1. Incoming call alerts in connected instrument cluster.
2. Incoming SMS alerts in connected instrument cluster (applicable only for Android smart phones).
3. Number of missed call alerts in connected instrument cluster.
4. Battery status of your smart phone in connected instrument cluster.
5. To send auto reply SMS to the callers via smart phone (applicable only for Android smart phones).

6. " Do Not Disturb" mode during the ride (applicable only for Android smart phones).
7. To send navigational assist instructions inputs to the connected instrument cluster from your smart phone.
8. To save the last traveled route.
9. To locate the last parked location of your TVS Apache RTR 200 Fi 4V.
10. To know the signal strength of your mobile network in connected instrument cluster.
11. To generate and store Ride reports.
12. To sync the connected instrument cluster clock with smart phone clock.

This dedicated mobile app of your 'TVS Apache RTR 200 Fi 4V' can be downloaded from the Google Play and the Apple store® by searching the key word '**TVS CONNECT - (country name)**'.

Note

*This smart phone app is compatible only for the smart phones with Android OS version Kitkat (4.4) and above, iOS version 11 and above and the BLUETOOTH version 4.0 and above. **Android and Google Play are trademarks of Google LLC. App Store® and iOS are trademark of Apple.***

How to login

On opening the **TVS CONNECT** app the following introductory screens will be displayed.



Move to the last screen where you will find the 'SIGN UP' and 'LOGIN' tab. If you are having login already then press login tab. A screen with various login options opens-up as shown.

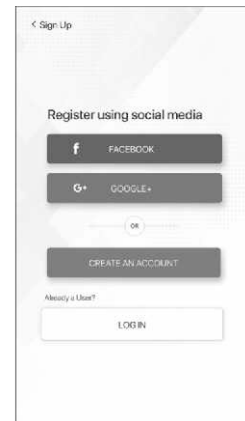
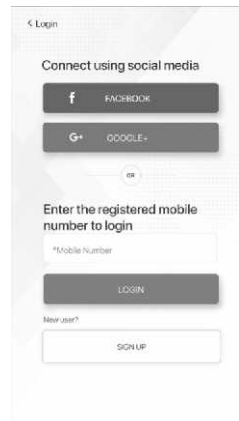

You can login using your social media logins like FACEBOOK and GOOGLE+ or using your mobile number which has been registered already.

If you are a new user then press the sign up tab where you will find various options for registering using your social media logins like FACEBOOK and GOOGLE+ or a tab for creating new account.

Using your social media logins you can create new login else press the 'CREATE AN ACCOUNT' tab.

KNOW YOUR TVS APACHE RTR 200 Fi4V

On pressing the 'CREATE AN ACCOUNT' tab, a screen opens with various input details. Feed in your details and submit. On submitting the details a screen opens with one time password (OTP) entry.

< Sign Up

Fill in your details

*Full Name

*Mobile Number

*Email ID

*City

*mandatory fields

I accept Terms & Conditions

SUBMIT

< Verify OTP

An OTP has been sent to your mobile number

Enter OTP

SUBMIT

[RESEND OTP](#)

Waiting for OTP: 23

Enter the OTP which is received from TVS Motor Company Limited and submit. On submitting the OTP, another screen opens where you have to enter your vehicle's chassis number for verification.

< Add a vehicle

Hello Janarth,

Add your TVS bike by entering your chassis number

Chassis/Frame Number

[View Sample](#)

VERIFY

Need assistance regarding your chassis number?

GET HELP

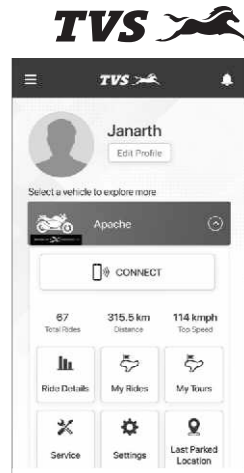

After successful verification of your chassis number, the Home screen of the app opens.

i Note

Please remember that the navigation License has to be renewed after 5 years of vehicle purchase and renewal can be done by contacting near by Distributor or Dealers end.

Add vehicle

Add vehicle tab allows you to add any of your TVS bikes by entering its chassis number. You can have sample view of the frame number and also you can get help by chatting with us or by E-mailing to us or by calling us.

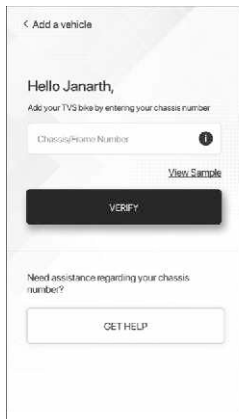

< Add a vehicle

Hello Janarth,

Add your TVS bike by entering your chassis number

Chassis/Frame Number

[View Sample](#)

VERIFY

Need assistance regarding your chassis number?

GET HELP



< Get Help

Need assistance with updating your phone details? Get in touch

Chassis No*:

Name*:

Upload RC copy*: Maximum size of 5 mb allowed

Upload Driving License*: Maximum size of 5 mb allowed

Number to be updated*:

Comments:

COOLING SYSTEM

TVS Apache RTR 200 Fi 4V is designed with an external oil cooler with stone guard arrangement for optimal engine cooling.

The oil cooler is mounted in front of the engine which improves the engine durability and provides better heat management without any compromising the engine performance.

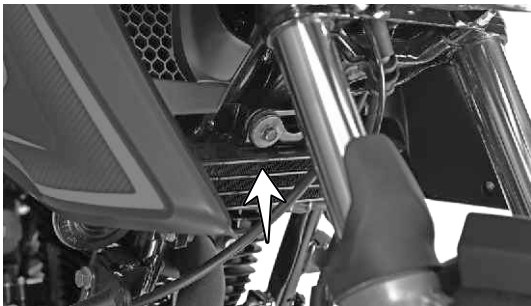

RAM AIR DUCT

TVS Apache RTR 200 Fi 4V is designed with a ram air duct on the right side of the fuel tank. This ram air duct throws air exactly above the spark plug while the vehicle is in move.

The air thrown above the spark plug cools the plug and maintains its temperature in optimum level. Which in-turn results in better heat management without any compromise on the engine performance and improves the engine's durability.

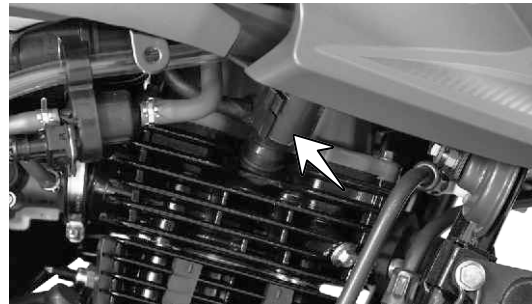

Caution

Care should be taken not to block the ram air duct air passage by cover or any other means. Else it will lead to over heating of engine or seizure.

LED HEAD LAMP

TVS Apache RTR 200 Fi 4V comes with a LED head lamp which glows automatically once the ignition is turned 'ON'.

Only the head lamp beam (high/low) can be controlled by pressing the high/low beam switch.



FUEL TANK CAP*

Flush type fuel tank cap (1) is provided in TVS Apache RTR 200 Fi 4V. To open the fuel tank cap, lift the protection lid (2), insert the control key into the lock and turn it in clockwise and lift the cap. Press the cap back to close. Rotate the key anti-clockwise, take out the key and close the lid.

To avoid accumulation of water in the fuel tank, a small drain hole and a pipe is provided in the fuel tank lid cavity so that the water entering through the lid is drained out through a hose.



** The fuel tank is not a measuring instrument and the capacity of the fuel tank may slightly vary from the indicated capacity.*

⚠ Warning

Do not smoke while refueling. Do not use cell phones while refueling. Avoid spilling of fuel on the hot engine. Refill petrol in well ventilated area. Switch off the engine while refueling as petrol is highly inflammable. After refilling close the cap properly.

EVAPORATIVE EMISSION CONTROL SYSTEM

This vehicle is fitted with Evaporative Emission Control System (EVAP system with canister). If there is any abnormal jerk, startability issue are felt in the vehicle or noise due to sudden escape of gas during opening of fuel tank cap, immediately report to the TVS Motor Company Distributor, Dealers / Authorised Service Centers.

⚠ Caution

Never fill fuel beyond the fuel tank inlet (1). Filling above the inlet may result in improper breathing of fuel tank which leads to difficulty in starting as well as improper running of the vehicle.

Whenever refueling the bike fill only the recommended quantity of fuel (10 liter including reserve).

Do not clean the vehicle by laying down on floor, to avoid fuel entry into EVAP system.

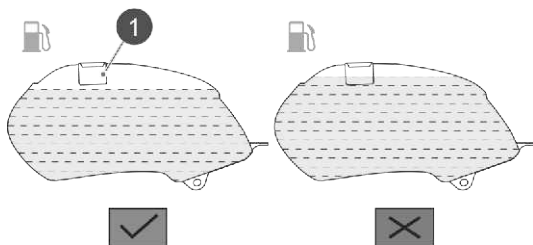

STANDS

TVS Apache RTR 200 Fi 4V is equipped with a centre stand (1) and side stand (2).

To place the vehicle on the centre stand, hold the handle bar left grip with left hand and pillion handle with right hand. Place your foot firmly on the centre stand extension (1a) and press with adequate effort. Ensure both the legs of centre stand are touching the ground before placing the vehicle on the stand.

Side stand can be operated by sitting on the vehicle with your left foot by pushing it away from the vehicle to its extreme end.

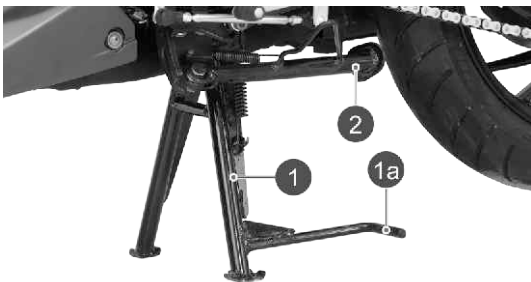

Caution

Do not sit on the vehicle when it is parked on the side stand / centre stand, as your full weight would rest on the vehicle's only support.

Warning

Park the motorcycle safely on a solid ground. On slopes, engage the first gear and park the vehicle in such a way that the front wheel faces uphill. Always release the side stand to its full up position before moving the vehicle.

SEAT

The seat lock is located between the rider and the passenger seat assembly.

Rear seat (passenger seat)

To remove the rear seat (1), insert the ignition key into the seat lock (2). Turn it clockwise, pull & release the front section of the seat first, followed by the rear section as shown in the above figure. To install the rear seat, reverse the removal procedure.

 **Caution**

Make sure that the seat is locked securely in position.

Utility box is located under the passenger seat to store some important items and it provides security to things placed inside.

Front seat (rider seat)

To remove the front seat (3), remove the rear seat (passenger seat) and take out the key from the lock. Take out the utility box by gently dislocating it from seat release cable (A).

Pull the seat release cable (A) to release seat lock. Keeping the seat release cable pulled, lift the seat from rear end & slide it backward to remove.

To install the front seat, reverse the removal procedure.



TOOL KIT

To assist you in performing certain aspects of periodic maintenance and emergency repairs, a tool kit is supplied along with the vehicle.

Tool kit located under the passenger seat. To access the tool kit, remove the passenger seat as explained in page No. 52.

Tool kit consists of one number each of the following.

1. Grip driver
2. Bit (+) (-)
3. 12 x 14 open end spanner
4. Tool bag



Caution

It is recommended to use the tool kit in case of any emergency only. It is always advisable to take your vehicle to TVS Motor Company Distributor, Dealers / Authorised Service Centers.

Warning

Do not remove the tool kit and first aid kit from the vehicle. Always ensure to keep them along with the vehicle. Ensure the first aid equipments are changed periodically based on the date of expiry.

COVER FRAMER



Removal

Cover frame R is provided to access the battery and rear disc brake master cylinder. This cover can be opened in the following manner:

1. Remove the seats as explained in page No. 53.
2. Remove the mounting screws (1), (2), (3) and take out the cover frame.

Re-install

1. Locate the lugs of the cover frame at the holes provided on the frame and install the mounting screws (1), (2) and (3).

Caution

Make sure that the cover frame is locked securely in position after installation.

ADJUSTMENTS

CLUTCH LEVER - ADJUSTMENT

TVS Apache RTR 200 Fi 4V comes with an adjustable clutch lever. There are three positions provided for you to adjust the lever to suit your palm size. The lever can be adjusted by adjusting the "position adjuster" (A) provided in the knob itself. Position-1 is the closest to handle bar grip and Position-3 is the farthest.

To adjust the lever position, push the lever forward and rotate the "position adjuster" to any of the three positions by aligning the 'arrow mark' on the lever to the number provided on the adjuster.



FRONT BRAKE LEVER - ADJUSTMENT

TVS Apache RTR 200 Fi 4V comes with an adjustable front brake lever. There are three positions provided for you to adjust the lever to suit your palm size. The lever can be adjusted by adjusting the "position adjuster" (B) provided in the knob itself. Position-1 is the closest to handle bar grip and Position-3 is the farthest.

To adjust the lever position, push the lever forward and rotate the "position adjuster" to any of the three positions by aligning the 'arrow mark' on the lever to the number provided on the adjuster.



Caution

Do not try doing any adjustment while riding as it may lead to fatal accident.

Do not use any tool or objects to turn the "position adjuster". Do it by hand only.

Note

While adjusting the lever position, ensure the proper aligning of "position adjuster" number with the arrow mark on the lever.

Check and ensure the proper free play of both clutch and front brake after adjusting the lever position.

FRONT SUSPENSION - ADJUSTMENT



TVS Apache RTR 200 Fi 4V front suspension level can be adjusted as per your convenience. Adjust the suspension level as per the load or road conditions.

To adjust the suspension level rotate the knob (A) either towards 'H' (clockwise) or towards 'S' (anti-clockwise) position. Turning the knob towards 'H' increases the pre-load which makes suspension harder and turning the knob towards 'S' decreases the pre-load which makes suspension softer. This adjustment can be made even using a coin.

There are grooves provided in the adjuster for aligning it with top surface of the fork bolts while adjusting the suspension level. By default the third groove from the top is aligned with the surface.

1st groove -
hard
suspension



3rd groove -
Standard
position

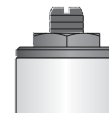

5th groove -
soft
Suspension



Caution

Ensure to keep both left and right adjuster level at the same position to avoid improper suspension feel.

Ensure not to damage the adjuster groove or the top surface of the fork bolts.

PRE RIDE INSPECTION

Check the following items before riding

| ITEM | WHAT TO CHECK FOR |
|-----------------------------|--|
| Engine cum transmission oil | Availability of oil upto the level (page no. 72) |
| Fuel | Enough fuel for the planned distance of running |
| Tyres | Correct pressure (page no. 78) Adequate tread depth / No cracks or cuts |
| Battery | Proper working of all lamps, horn and pass by switch. Low battery indication |
| Speedometer | Performing self check / Proper working of ABS warning lamp (page No.17) |
| Malfunction indicator | Turned OFF after starting the engine (page No. 23) |
| Steering | Smooth movement / No play or looseness |
| Throttle | Correct free play of cable / Smooth operation |
| Clutch | Correct free play of cable (page no. 73) / Smooth and progressive action |
| Brakes | Availability of brake fluid and proper working of brake (page no. 76) |
| Wheels | Free rotation |
| Drive chain | Slackness and lubrication of chain (page no. 80) |

Caution

Do not switch 'ON' the ignition without minimum level fuel in tank. It will cause damage to the fuel pump.

STARTING THE ENGINE

As you turn the ignition switch to the 'ON' position, the instrument cluster and the warning lights will go through the self-diagnostic cycle. During this phase, make sure that all the warning lights on the cluster comes on.

The following conditions must be verified before starting the engine.

- ❑ The engine cut off switch is in 'O' position.
- ❑ The gear is in neutral.
- ❑ If gears are engaged, the clutch lever is pulled.

Press the start button without applying the throttle. As soon as the engine starts, release the start button.

The engine will not start if the throttle is opened full.

Caution

Do not keep the engine in idling rpm for long and do not open excessive throttle when the vehicle is parked. It leads to overheating of engine and damage to the internal components.

SETTING THE VEHICLE IN MOTION

1. Press the clutch lever and engage first gear by pressing the gearshift lever down.
2. Open the throttle slowly and simultaneously, release the clutch lever gently and gradually. The vehicle starts moving forward.
3. As the vehicle picks up speed, shift to the next higher gear by closing the throttle, applying the clutch and lifting the gear shift lever up.
4. Release the clutch lever and open the throttle smoothly. Select the required gears in a similar manner.

Using the transmission

The transmission is provided to keep the engine to run smoothly in its normal operating speed range.

The gear ratios have been carefully chosen to meet the characteristics of the engine.

The rider should always select the most suitable gear to achieve the necessary speed and pulling power smoothly.

Riding on hills/gradients

When climbing steep hills, the motorcycle may begin to slow down and show lack of power. At this point the rider should shift to a lower gear so that the engine will again be operating in its normal power range. Shift gears rapidly to prevent the motorcycle from losing momentum.

When riding down a hill, the engine may be used as brake by shifting to a lower gear.

STOPPING AND PARKING

1. Close the throttle completely and apply both the brakes simultaneously.
2. Down shift the gears with clutch lever pressed / disengaged as the road speed decreases. Bring the engine to neutral position just before the vehicle stops.
3. Turn the ignition 'OFF'.
4. Park the vehicle on a firm, flat surface.
5. Lock the steering.

Warning

Reduce speed to a safe limit before turning/cornering. Do not apply brake while turning/cornering. Do not disengage clutch before braking.

Warning

Since the engine and exhaust system becomes very hot, make sure to park the vehicle in a place where pedestrians or children are not likely to touch the hot surface. Do not park near dry grass or any other flammable resources which might catch fire.

To avoid deterioration of paint gloss due to ultra violet rays and heat of sunlight, always park your motorcycle in a covered parking.

FUEL RECOMMENDATION

Use unleaded petrol only.

The petrol should be 85 to 95 octane by research method. Use recommended fuel additives for longer life of engine components and lower maintenance. Petrol mixed with ethanol will have impact on engine components. Contact your TVS Motor Company Authorised Distributor or Dealers / Authorised Service Center for usage.

Caution

Never mix oil and petrol in the fuel tank. Always fill fuel from reputed and reliable fuel stations.

Note

Use fuel additives in petrol as recommended by the respective manufacturer for low carbon deposition.

CHECKS AND TIPS FOR IMPROVING FUEL ECONOMY

Regular checks

Carry out the periodic maintenance checks as specified in this manual (refer page no. 24 to 31).

Regular maintenance checks will save fuel ensuring trouble-free, enjoyable and safe riding besides keeping the environment clean .

Spark plug

A dirty or defective spark plug leads to wastage of fuel due to incomplete combustion. Inspect and clean the spark plug if necessary. Visually inspect the spark plug gap. If the gap is found more replace the plug with a new one.

However the spark plug need to be replaced every 12000 kms (1 year). Always use recommended spark plug only.

Caution

*Do not remove the spark plug when the engine is hot.
Please ensure that the ram air duct is not getting damaged during removal / reassembly of spark plug.*

Air cleaner element

A dirty air cleaner element restricts airflow and increases fuel consumption. Replace the element every 12000 kms.

Since paper filter is used in your motorcycle, it is not advised to clean the filter. Replace the filter in case of any abnormalities.

Clutch

Increase in engine rpm during acceleration, without increase in road speed indicates clutch slip. A slipping clutch will cause high fuel consumption and overheating of engine.

If the condition persists even after adjusting the clutch lever play, immediately have the clutch checked by TVS Motor Company Authorised Distributor or Dealers / Authorised Service Center.

Caution

Never drive the vehicle with the clutch lever pressed. This will reduce the life of clutch and affect the vehicle performance and fuel economy.

Engine cum transmission oil

Dirty or less engine cum transmission oil increases the friction between various parts of the engine and reduces the engine life, thereby increases fuel consumption.

Regularly inspect the engine cum transmission oil for correct level and top-up if necessary. Get it replaced at regular intervals as per the maintenance schedule. Always use TVS TRU4 FULLY SYNTHETIC oil only (SAE 10W30 API-SL, JASO Ma2).

Fuel leak

If any fuel leak is suspected, tow the vehicle to the nearest TVS Motor Company Authorised Distributor or Dealers / Authorised Service Centers and get it corrected.

Tyres

Low tyre pressure has adverse effects on the vehicle. The drag on the vehicle increases resulting decreased fuel economy. Further more, handling may be affected adversely.

Caution

Do not attempt to do any rectification, as fuel lines are normally pressurized upto 3.5 bar and any activity by any untrained personnel, may lead to un-safe condition.

Check the tyre pressure regularly (weekly) and inflate them to the recommended pressure (refer page no. 78). Never use tyres which are worn out beyond the permissible limit.

Chain slackness

Check and ensure drive chain slackness. Excess slackness leads to higher fuel consumption (refer page no. 80).

Wheels free movement

Check and ensure the free movement of wheels by rotating the them at least once in a week to avoid wastage of fuel.

Fast starting from rest wastes fuel

A racing start from rest at full throttle will waste fuel and damage the engine. It also creates a potentially dangerous traffic situation. Fuel is wasted whenever the rider suddenly accelerate or apply brake.

Avoid unnecessary idling

While waiting for someone or stopping in signals for long time, if the engine is kept running at idle speed, it causes unnecessary wastage of fuel.

Avoid frequent braking

Anticipate corners and slopes as well as the traffic conditions. Unnecessary and frequent braking reduces the fuel economy.

Note

Please note that the on-road mileage of TVS Apache RTR 200 Fi 4V is dependent on several factors like road condition, quality of fuel, riding speed, operation of clutch and brake, tyre inflation, maintenance / timely servicing of vehicle, load etc.. and hence will differ from the mileage given under standard test conditions.

MAINTENANCE SCHEDULE

The maintenance schedule indicates the intervals between periodic services. At the end of each interval, be sure to inspect, check, replace, adjust, lubricate and service as instructed. If the maintenance is not done periodically, it will result in rapid wear and severe damage to the vehicle. If the vehicle is used under high stress conditions such as continuous full throttle operation or is operated in dusty area, certain jobs should be performed more often to ensure reliability of the vehicle. Cylinder head, steering components, suspension, chain and wheel components etc., are key items and require very special and careful servicing. TVS Motor Company Limited strongly recommends that the jobs as per the maintenance schedule be performed by your TVS Motor Company Authorised Distributor or Dealers / Authorised Service Centers.

Periodic inspections may reveal one or more parts that may need replacement. Whenever replacing parts on TVS Apache RTR 200 Fi 4V, it is recommended that you use only the TVS Motor Company Genuine parts.

Caution

Proper running-in and maintenance are mandatory for making certain that your vehicle is reliable and gives optimum performance at all times. Make sure that the periodic maintenance is performed thoroughly in accordance with the instructions given in this owner's manual.

In more dusty areas, the air filter element required early replacement than the mentioned kilometers to avoid costly damages to the engine.

PERIODIC MAINTENANCE SCHEDULE (months or km whichever occurs earlier)

| Item | Service km Period from the date of sale | Service | | | | | | Remarks | |
|----------------------------------|--|---------------------------|------------------------------|------------------------------|------------------------------|---------------------------------|------------------|---------|--|
| | | 1st 500-750 1 month | 2nd 2500-3000 3 months | 3rd 5000-6000 6 months | 4th 8500-9000 9 months | 5th 11500-12000 12 months | Every 3000 km | | Every 6000 km |
| Engine cum transmission oil | | R | I&T | R | I&T | R | I&T | R | |
| Oil filter (strainer) | | C | - | C | - | C | - | C | |
| Oil filter (paper filter) | | R | - | R | - | R | - | R | |
| Spark plug ¹ | | I | - | - | - | R | - | - | Replace every 12000 km |
| Air cleaner element | | I | - | - | - | R | - | - | Replace every 12000 km |
| Tappet clearance | | I & A | - | I & A | - | I & A | - | I & A | Adjust if required |
| Oil cooler fins | | - | - | I & C | I & C | I & C | I & C | - | |
| Oil cooler pipes | | - | I | I | I | I | I | - | Inspect & replace if required every 15000 km |
| Clutch plates | | - | - | - | - | - | - | - | Inspect & replace if required every 21000 km |
| Engine breather hose | | I | I | I | I | I | I | - | Replace every 21000 km if required |
| Throttle body rubber ducts | | - | I | I | I | I | I | - | Replace every 21000 km if required |
| Fuel filter | | I | I | I | I | I | I | - | |
| Hose fuel with respective clamps | | I | I | I | I | I | I | - | Replace every two years or 21000 km |

¹ Replace every 12000 km or 1 year whichever is earlier.

| Item | Service km Period from the date of sale | Service | | | | | | Remarks | |
|---|--|---------------------------|------------------------------|------------------------------|------------------------------|---------------------------------|------------------|---------|---|
| | | 1st 500-750 1 month | 2nd 2500-3000 3 months | 3rd 5000-6000 6 months | 4th 8500-9000 9 months | 5th 11500-12000 12 months | Every 3000 km | | Every 6000 km |
| Throttle grip | | – | – | L | – | L | – | L | Lubricate using grease |
| Clutch and throttle cable play ² | | I, A & L | I, A & L | I, A & L | I, A & L | I, A & L | I, A & L | – | |
| Steering smooth operation/play ³ | | I & A | – | – | – | C, L & A | – | – | C & L with fresh Bechem premium grade 3 grease every 12000 km |
| Front and rear suspension ⁴ | | I | I | I | I | I | I | – | |
| All fasteners | | I & TI | I & TI | I & TI | I & TI | I & TI | I & TI | – | Tighten if necessary |
| Drive chain** | | C, L & A | C, L & A | C, L & A | C, L & A | C, L & A | C, L & A | – | Adjust if necessary |
| Retainer oil seal ⁵ | | I | I | I | R | I | I | – | Replace every 9000 km |
| Chain guide bottom ⁶ | | I | I | I | R | I | I | – | Replace every 9000 km |

² Inspect for proper operation and adjust play. Lubricate ends using grease.

³ Inspect for smooth steering rotation, steering shake / noise. Adjust the steering if necessary.

⁴ Inspect for smooth and proper function of front and rear suspension. Also inspect for any visual damage and oil leakage.

^{5,6} Inspect at every service. Replace if found damaged. However the retainer oil seal & the chain guide bottom need to be replaced every 9000 km.

** Clean the drive chain with dry cloth and apply TRU SPRAY / TRU 4 oil as frequently as every 500 km for better chain life and smooth vehicle running. Check drive chain, rear sprocket and engine sprocket for wear. If any part is worn, replace the same. Always replace the engine sprocket, rear sprocket and chain together.

Contd...

| Item | Service km | Service | | | | | | Remarks | |
|--------------------------------------|---------------|---------------------------|------------------------------|------------------------------|------------------------------|---------------------------------|------------------|---------|-----------------------------------|
| | | 1st 500-750 1 month | 2nd 2500-3000 3 months | 3rd 5000-6000 6 months | 4th 8500-9000 9 months | 5th 11500-12000 12 months | Every 3000 km | | Every 6000 km |
| All bulbs, horn and switches | | I | I | I | I | I | I | - | Inspect for proper functioning |
| Head lamp beam | | I & A | I & A | I & A | I & A | I & A | I & A | - | |
| Battery voltage ⁷ | | I | I | I | I | I | I | - | |
| Brake effectiveness | | I | I | I | I | I | I | - | |
| Brake pedal shaft | | L | L | L | L | L | L | - | Lubricate using TRU4 oil |
| Brake pad wear | | I | I | I | I | I | I | - | Replace if necessary |
| Brake fluid | | I & T | I & T | I & T | I & T | I & T | I & T | - | |
| WSS / toner ring | | I & C | I & C | I & C | I & C | I & C | I & C | - | Replace if damaged |
| WSS cable clamps - (front & rear) | | I | I | I | I | I | I | - | Fix new clamp if found missing |
| WSS cable | | I | I | I | I | I | I | - | Replace if damage |
| Brake hose / bundy tubes | | I | I | I | I | I | I | - | Replace every 30000 km |
| Bundy tube mounting (all joints) | | I & TI | I & TI | I & TI | I & TI | I & TI | I & TI | - | Inspect for leak |
| HECU mounting cushions | | - | - | I | - | I | - | I | Replace every 30000 km |

R - Replace; I - Inspect; T - Top up; C - Clean; A - Adjust; L - Lubricate; TI - Tighten; S - Set

⁷ Recharge if necessary.

Contd...



| Item Service km Period from the date of sale | Service | | | | | | | Remarks |
|--|---------------------------|------------------------------|------------------------------|------------------------------|---------------------------------|------------------|------------------|--|
| | 1st 500-750 1 month | 2nd 2500-3000 3 months | 3rd 5000-6000 6 months | 4th 8500-9000 9 months | 5th 11500-12000 12 months | Every 3000 km | Every 6000 km | |
| Toner rings teeth damage | I | I | I | I | I | I | - | Replace if necessary |
| Malfunction codes & MIL check | I | I | I | I | I | I | - | |
| Master cylinder cups | - | - | - | - | - | - | - | Replace every 21000 km |
| Wheel freeness | I | I | I | I | I | I | - | |
| Tyre pressure at cold condition | I & S | I & S | I & S | I & S | I & S | I & S | - | |
| Ball joint gear shift lever | - | - | L | - | L | - | L | Lubricate using grease |
| Centre / side stand pivot | L | L | L | L | L | L | - | Lubricate using TRU4 oil |
| Swing arm bearings | - | - | - | - | - | - | - | C & L with fresh Bechem premium grade 3 grease every two years |
| Wheel balancing ⁸ | - | - | - | - | I | - | - | |
| Evaporative emission control system | I | I | I | I | I | I | - | Check for intactness of hoses and canister |
| Fuel tank assembly** | I & C | I & C | I & C | I & C | I & C | I & C | - | |

R - Replace; I - Inspect; T - Top up; C - Clean; A - Adjust; L - Lubricate; TI - Tighten; S - Set

⁸ Wheel balancing to be done every 1 year or every 12000 km. In addition, after every tyre puncture repair or tyre replacement, wheel balancing to be done.

** Check for abnormal vehicle jerk / noise while opening the cap / leak. If found any, contact TVS Motor Company Authorised Main Dealer or Authorised Dealer.

Replace front fork oil if found any oil leak and other front fork related service

RECOMMENDED LUBRICANTS

| Application | Qty | Manufacturer | Brand |
|-----------------------------|--|---------------------|--|
| Engine cum transmission oil | 1200 ml (during servicing) 1400 ml (during engine overhaul) | TVS Motor Company | TVS TRU4 FULLY SYNTHETIC oil (SAE 10W30 API-SL, JASO MA2) |
| Front fork oil | 329 ± 2 cc | | KYB G10 oil |
| Disk brake fluid | – | TVS Girling | DOT 3 / DOT 4 |
| Grease | – | Bharat petroleum | MP Grease no. 3 |
| | | IOC | Servo Gem no. 3 |
| | | Bechem | Bechem premium grade 3 |
| Chain lubricant | – | TVS Motor Company | TRU SPRAY |



SELF - MAINTENANCE PROCEDURES BATTERY

To ensure better performance and long life of battery, you are requested to follow the steps given below:

1. Remove the cover frame R (refer page No. 55).
2. Check the battery voltage. If the voltage measured is less than 12.4V, charge the battery using TVS Motor Company Limited recommended battery charger only at TVS Motor Company Authorised Distributor or Dealers / Authorised Service centers.
3. Apply petroleum jelly to the terminals to avoid corrosion.
4. Do not add additional electrical accessories.

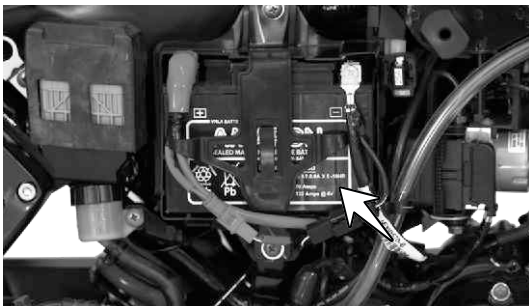

Caution

Never check the battery charge by shorting the terminals. Always connect the positive terminal first (red wire) and then negative (black wire) to avoid sparking.

The inversion of the battery wires can damage the battery and the recharging system.

If the motorcycle is to remain unused for a long time (a month or longer), it is advisable to disconnect the battery cables or have the battery removed by skilled personnel.

FUSE REPLACEMENT

The electrical components of your motorcycle are protected by four fuses. Out of which three fuses are housed inside a fuse box and located below the rear seat (passenger seat). One fuse is located below the cover frame near the battery.

To access the fuses located below the passenger seat:

1. Turn 'OFF' the Ignition.
2. Park the motorcycle on a flat firm surface and remove the passenger seat and utility box as explained in page No. 52.
3. Open the fuse box lid.



Good Fuse

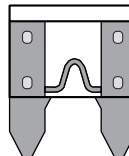

Blown Fuse

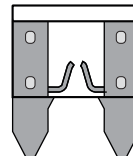

4. The fuse box contains one 15A fuse, one 10A fuse and one 20A fuse. The 20A fuse is used for ABS incase of dual channel ABS system. But incase of single channel ABS system, 15A is provided instead of 20A fuse. Use the 'fuse puller' (A) placed near the fuse box to pull out the blown fuse.
5. Replace the blown fuse with a new one with same rating (extra fuses are provided inside the fuse case itself).
6. Close the fuse box lid and fix back the utility box & passenger seat.

To access the fuse located below cover frame:

1. Remove the cover frame R as explained in page No. 55.
2. Open the fuse holder and pull out the blown fuse (Main Fuse - 25A).

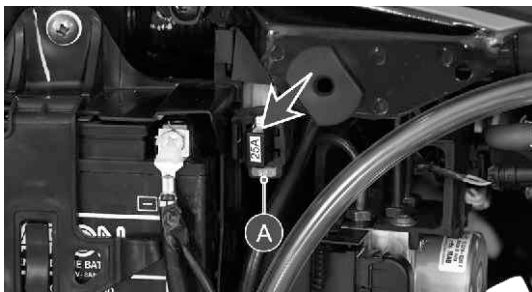

3. Replace the blown fuse with a new one with the same rating (extra fuse (A) is provided in the fuse holder itself).
4. Turn 'ON' the ignition lock and check for proper functioning of electrical and ABS system. In case if the fuse fails again, consult the nearest TVS Motor Company Authorised Distributor or Dealers / Authorised Service Centers.

Caution

Do not use vehicle by **shorting the wires without a fuse**. This may result in overheating of electrical / wiring and may result in fire. Never replace a fuse with a rating other than that prescribed, in order to avoid damage to the electrical equipment.

SPARK PLUG

1. Wipe and clean the dust and mud around the spark plug mounting to avoid their entry inside the cylinder.
2. Pullout the suppressor cap from spark plug. Remove the spark plug using a plug spanner.

A spark plug with heavy carbon deposits will not produce strong sparks. Hence, only if necessary, remove the carbon deposits from the spark plug with a small wire brush or spark plug cleaning tool.

Inspect the spark plug electrodes (A) and (B) for any corrosion. If found any replace the spark plug with a new one.

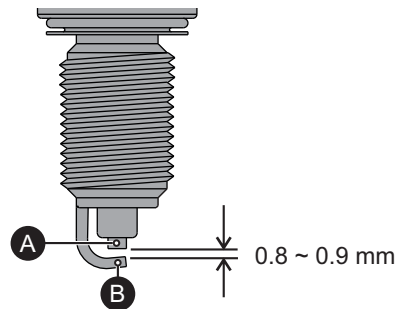

Visually inspect the spark plug gap. The gap should be 0.8 ~ 0.9 mm. If the gap is found to be more than the limit replace the spark plug with a new one.

After cleaning and inspecting the gap, reinstall the spark plug and tighten by hand to avoid cross threading. Finally tighten using the spanner. Do not over tight or cross thread the spark plug.

Caution

Always use only recommended make and type of spark plug. **Replace spark plug every 12000 km or 1 year whichever is earlier.**

Cover the spark plug hole with a cloth when the plug is removed to prevent entry of dust/water.

It is advisable to tighten the new spark plug by hand till the end, using plug spanner tighten by 1/4 turn. Then loosen the plug by 1/8 turn and re-tighten using plug spanner.

Care should be taken not to damage the spark plug cooling duct (ram air duct) during dismantling / assembling the spark plug.

ENGINE CUM TRANSMISSION OIL

Check the engine cum transmission oil level periodically. The gauge oil level is provided at the right-hand side crankcase cover.

1. The check must be performed when engine is in cold condition, after placing the motorcycle in center stand with front wheel touching the ground.



2. Place the motorcycle in an upright position on a horizontal and firm surface.
3. Wipe-off the surroundings of gauge oil level.
4. Remove the gauge oil level and wipe it clean.
5. Re-insert the gauge oil level by completely screwing it in.
6. Once again remove the gauge and check the oil level.

7. The oil level should be between the minimum and maximum level marks on the gauge as shown in the figure.
8. If the oil level is below the minimum level, top up with TVS TRU4 FULLY SYNTHETIC oil (SAE 10W 30 API-SL, JASO MA2) upto the maximum level mark. Do not overfill.
9. Wipe out the oil traces with a clean cloth to prevent dust accumulation and re-fix the gauge.

Caution

Do not run the vehicle with insufficient / without engine cum transmission oil as it will cause serious damage to the engine components.

Excessive oil filling will cause oil leak and other malfunctions. Always use TVS TRU4 FULLY SYNTHETIC oil only (SAE 10W 30 API-SL, JASO MA2).

Make sure that no foreign object gets in the crankcase while topping up the engine oil.

Warning

Correctly recycle or dispose the used engine oil in order to avoid environmental pollution.

CLUTCH ADJUSTMENT

Clutch lever free play is one of the most important adjustment which you may need to check in-between services for better life of the clutch plates.

The free play of the clutch lever should be 8 ~ 13 mm as measured at the clutch lever end at handle bar.

Adjust the clutch lever free play periodically by means of clutch cable adjuster at arm clutch release. If the free play is not within the specified limit.

1. Ensure that the engine is cold (engine oil at room temperature).

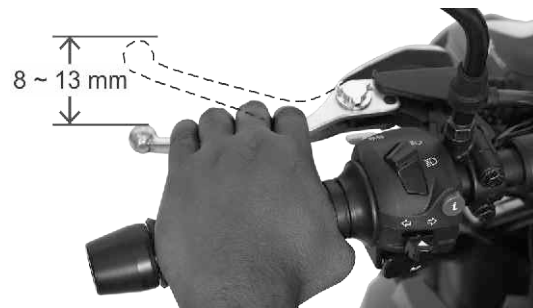

2. Loosen the lock nut (2) while holding the clutch cable adjuster (3).
3. Adjust the clutch cable adjusting nut (1) 'in' or 'out' to give sufficient play in the clutch lever.
4. After adjusting the play, hold the adjuster nut in the same position, tighten the lock nut.



Caution

Too much or too less clutch lever free play will damage the clutch plates, thereby affecting the performance of the vehicle.

Adjust the clutch lever free play only when the engine is cold.

Caution

After adjusting free play properly, if there is a clutch slip or there is difficulty in shifting gear, visit your TVS Motor Company Authorised Distributor or Dealers / Authorised Service Centers for rectification.



REAR SHOCK ABSORBER

TVS Apache RTR 200 Fi 4V is provided with dual rated, 7 step adjustable, gas filled rear shock absorber to meet different road and load.



i Note

During the time of delivery of the motorcycle, the rear suspension is adjusted to the standard configuration.

Rear shock absorber spring stiffness can be set to your convenience. Contact your TVS Motor Company Authorised Distributor or Dealers / Authorised Service Centers for setting the rear shock absorber load.

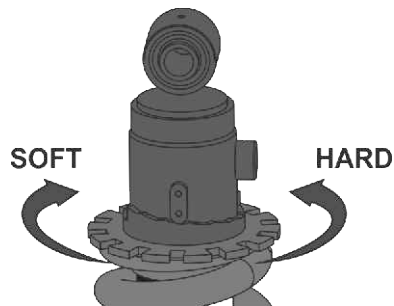

! Warning

The rear shock absorber contains highly compressed gas. Do not try to open or disassemble it in any way.

! Caution

Adjust step by step. Do not go at a stretch as it will damage the cam.

BRAKES

Front brake

You can observe a master cylinder (1) on the right side of the handle bar, a caliper assembly (2) fitted to the fork leg R along with a wheel speed sensor (3), a disc (4) and the toner ring (5) to the front wheel. Also you can observe a high pressure hose connecting the master cylinder to the HECU of ABS system and another hose connecting HECU to the caliper assembly.

1. Check the master cylinder brake fluid level through the view piece glass (A).

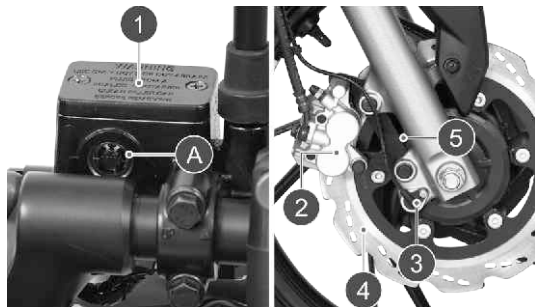

2. Brake fluid level always should be above the 'LOWER' mark (B) on the master cylinder when the master cylinder is parallel to the ground.
3. If the brake fluid level is below the mark or while applying brake if you feel the brake is more spongy or ineffective due to air entry, contact TVS Motor Company Authorised Distributor or Dealers / Authorised service centers for topping-up the brake fluid, air bleeding and other brake related inspections.



i Note

Check the brake fluid level only when the master cylinder is parallel to the ground.

Rear brake

You can observe a master cylinder (1) mounted on the right side pillion foot rest, a reservoir (2) below the cover frame R, a caliper assembly (3) fitted on the rear wheel axle along with wheel speed sensor (4)*, a disc (5) and toner ring (6)* to the rear wheel. Two high pressure hoses connecting the master cylinder to HECU* and HECU* to the caliper (in non ABS version high pressure hose is connected directly to the caliper assembly).

1. Remove the cover frame R (refer page No. 55 for removal procedure).

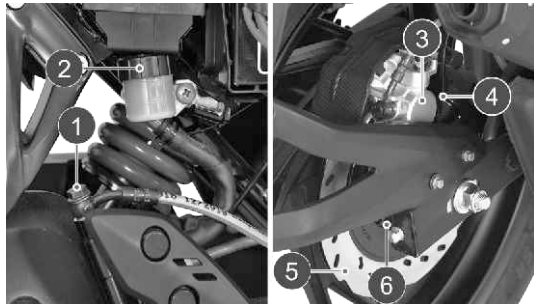

Not applicable of non ABS type rear brake system

2. Check the brake fluid level in the reservoir. It should be between maximum and minimum level.
3. If the brake fluid level is below minimum or while applying brake if you feel the brake is more spongy or ineffective due to air entry, contact TVS Motor Company Authorised Distributor or Dealers / Authorised Service Centers for topping-up the brake fluid, air bleeding and other brake related inspections.



i Note

Check the brake fluid level only when the master cylinder is parallel to the ground.

Brake pad wear indicator

Visually check the brake pads for wear. If the wear is found beyond the wear indicator groove as shown in the figure then, replace the brake pads as a set with a new one.

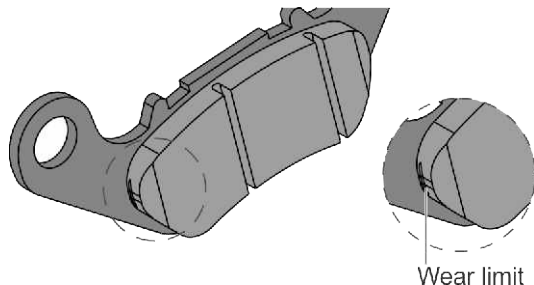

⚠ Warning

Lack of maintenance of the brake system increases the risk of accident. If you notice any malfunction in brake system contact nearest TVS Motor Company Authorised Distributor or Dealers / Authorised Service Centers.

⚠ Caution

Replace the brake pads as a set, if the wear indicator shows beyond the wear limit.

TYRES*

Tyre pressure:

Check the tyre pressure atleast once in a week if not more frequently. Insufficient air pressure in the tyres not only hasten tyre wear, but also seriously affects the stability of the vehicle.

Under-inflated tyres make smooth cornering difficult and over-inflated tyres decreases the tyre contact with the ground which can lead to skidding and loss of control. Be sure that the tyre pressure is within the specified limits at all times.

| | Solo | Pillion |
|-------|----------------------------------|----------------------------------|
| Front | 1.75 kg/cm ² (25 PSI) | 1.75 kg/cm ² (25 PSI) |
| Rear | 2.00 kg/cm ² (28 PSI) | 2.25 kg/cm ² (32 PSI) |

⚠ Warning

The tyre inflation pressure in cold condition and the tyre thread condition are extremely important for the performance and safety of the rider. Check the tyres frequently for inflation pressure as well as the wear pattern on it. Use of a tyre other than the standard will cause instability.

Tyre tread condition

Operating the vehicle with excessively worn tyres will decrease riding stability and can lead to loss of control. It is recommended to replace the tyre when the tyre wears off to the tyre wear indicator level (indicated by TWI on the tyre).



- * **The pneumatic tyres fitted in this vehicle meet the requirements specified by BIS and comply with the requirements under the Central Motor Vehicles Rules (CMVR), 1989.**

Tyre rotation direction

While reassembling the tyre, after removing from wheel rim, ensure that the arrow mark (A) provided on the tyre, faces the direction of wheel rotation.

Tyre puncture

TVS Apache RTR 200 Fi 4V is fitted with a tubeless tyre on both front and rear wheel. In case of any puncture / tyre damage it is advised to visit nearest tyre manufacturer Dealer or the tyre repair shops who know the repairing methods of tubeless tyre. It is not necessary to remove the tyre from wheel rim always to attend the puncture. Even though, if there is a need of tyre removal, it is strongly recommended to use a tyre removal / fitment machine.

Caution

Side walls of the tubeless tyres which are in contact with the wheel rim are only seals the air inside the wheel assembly. Hence, care should be taken not to damage the side walls of the tyres during removal / reassembly.

Wheel balancing to be done every 1 year or every 12000 km. In addition, after every tyre puncture repair or tyre replacement, wheel balancing to be done.

If at all, tyre levers need to be used, the levers should be free from sharp edges and care should be taken not to damage the rim and tyre.

⚠ Warning

Use of a tyre other than the standard may cause instability and improper function of ABS.

Keep the toner ring upwards whenever the wheel is removed in order to avoid damage to the toner ring. Damaged toner ring affects the ABS function.

DRIVE CHAIN

Proper lubrication and adjustment of drive chain gives long service life of the chain. Poor maintenance of the chain causes premature wear or damage to the drive chain and sprockets. The drive chain must be cleaned, checked, lubricated and adjusted at specified intervals mentioned in the maintenance schedule.

Even though the chain is cleaned, lubricated and adjusted during regular service by the Dealers, the user must clean the chain with a dry cloth and apply TRU SPRAY / TRU4 oil as frequently as every 500 km for better chain life and smooth vehicle running.



Check, clean, lubricate and adjust the drive chain in the following manner:

1. Place the vehicle on centre stand with the transmission in neutral.
2. Inspect the drive chain slackness (vertical movement) using the finger as shown in the figure.
3. The slackness of the drive chain should not exceed the limit (20 ~ 25 mm).
4. If the slackness is found more contact TVS Motor Company Authorised Distributor or Dealers / Authorised Service Centers for adjustment.
5. If the slackness is found within the limit, clean the chain with a dry cloth and lubricate using TRU SPRAY/TRU4 oil.

Warning

Riding with improperly adjusted chain / high slackness can cause the chain to come off the sprockets resulting in accident or serious damage to the motorcycle.

Misalignment of rear wheel or sprockets can cause abnormal wear of chain and sprockets and results in unsafe riding condition.

Caution

Lubricate the drive chain after the motorcycle is washed with water or riding in rainy / wet condition.

The chain must be serviced more frequently when the vehicle is operated under severe conditions like dusty, muddy, wet, high speed or frequent starting / stopping.

FRONT WHEEL REMOVAL AND REASSEMBLY

1. Remove the axle nut (1) along with a washer.
2. Pull out the axle (2) along with a washer and remove a spacer from both the sides of the wheel.
3. Place a support below the frame to prevent vehicle from falling and lift the vehicle up.
4. Carefully dislocate the disc from the caliper assembly and slide the wheel out.
5. Reverse the procedure for reassembling.



Warning

Ensure proper seating of disc in the caliper assembly while reassembling the wheel.

Ensure to re-fix the right spacers at both the sides of the wheel.

Keep the toner ring upwards whenever the wheel is removed in order to avoid damages to the toner ring. Damaged toner ring affects ABS function.



REAR WHEEL REMOVAL AND REASSEMBLY

1. Remove the wheel hugger rear.
2. Remove the axle nut (1) and along with the washer and partially pull out the axle (2).
3. Take out the caliper assembly along with the wheel speed sensor* by dislocating it from the disc and the swing arm lug.
4. Carefully hang the caliper assembly in the swing arm itself. Take out the spacer and pull out the axle fully.
5. Remove the wheel assembly by gently tapping it along with the disc and toner ring*.

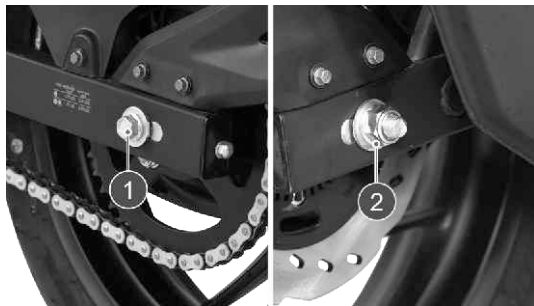

* Not applicable of non ABS type rear brake system

6. During re-assembly, engage the drum sprocket with the wheel along with the drive chain and then assemble the wheel into swing arm.
7. Re-assemble the other parts in the reverse order of removal.

Warning

Keep the toner ring upwards whenever the wheel is removed in order to avoid damages to the toner ring. Damaged toner ring affects ABS function.*

Caution

While assembling the caliper assembly ensure that the slot provided in the caliper is properly located to the lug provided in the swing arm assembly. Always make sure that whenever the wheel is removed, axle nut is properly re-tightened to the specified torque and chain play is re checked and adjusted if required.

Note

During removal of rear wheel axle hold the drum sprocket assembly with the hand as it may fall. Carefully hang the drum sprocket along with chain in the swing arm itself.

STORAGE PROCEDURES

For storage of your motorcycle for longer periods of over a month and above, we recommend to carry out the following steps:

1. Clean the vehicle thoroughly. Park the vehicle on centre stand.
2. Warm up the engine and drain engine cum transmission oil. Store the oil, if new, in a dust free container.
3. Empty the fuel tank.
4. Remove the spark plug and feed in several drop of engine cum transmission oil through spark plug hole. Crank the engine few times and reinstall the spark plug.
5. Remove the battery, store it away from direct sunlight and freezing temperatures.

Caution

Do not park the vehicle on a slope or soft ground or else it may fall.

During storage, the battery must be recharged on a constant current battery charger at recommended amperage at least once in a month.

6. Place a suitable support at the bottom of the frame so that both the tyres are off the ground. This will ensure better tyre life.
7. Cover up the vehicle completely with a clean tarpaulin or any other suitable cover. Store the vehicle inside a garage or similar area to avoid damage due to dust and rain. Make sure that the storage area is well ventilated and free from any source of flame or spark.

TAKING THE VEHICLE OUT OF STORAGE FOR REGULAR USE

1. Take the vehicle out of the garage and clean it thoroughly.
2. Remount the battery after bench charging if required.
3. Fill the engine cum transmission oil (TVS TRU4 FULLY SYNTHETIC - SAE 10W30 API-SL, JASO MA2) and check the oil level using the gauge.
4. Lubricate the parts as instructed in the maintenance schedule.
5. Fill up fresh petrol in the fuel tank.
6. Check and inflate the tyres to the specified tyre pressure.
7. Check and correct the points mentioned in page No. 59.

Caution

Avoid using alkaline solution like detergent soaps for washing. This may damage head lamp and other lamp assemblies.

Turn the ignition switch to 'ON' position. Start the engine and allow it to idle for a few minutes and ride out.

RECOMMENDED TIPS WHEN TAKING A LONG TRIP OF MORE THAN 500 KM

- A) Please keep the following items for use in case of emergency:
1. Complete tool kit / first aid kit
 2. Recommended spark plug one number.
 3. Turn signal lamp bulb one number.
 4. Throttle and clutch cables one number each.
- B) Precautions to be taken for the journey:
1. Ensure engine cum transmission oil and brake oil level are up to the level.
 2. Adequate fuel in fuel tank.
- C) Check your motorcycle for the following:
1. Tightness of all bolts and nuts with correct torque value.
 2. Fitness of tyres / tyre pressure / tread depth.
 3. All bulbs, indicators and horn function.
 4. Balancing of wheel
 5. Check proper functioning of ABS (through ABS warning lamp)
 6. Smooth functioning of all cables and their free plays.

7. Smoothness of steering operation.
8. Slackness and lubrication of chain (page No. 82)
9. Front / rear brake functioning and rear brake lamp switch adjustment.
10. Front fork for any abnormality.
11. Spark plug cleanliness and condition of spark plug.
12. Air filter element cleanliness.
13. Correct idling speed.
14. Lubrication of all items mentioned in the periodic maintenance schedule.
15. Intactness of EVAP system hoses and canister.
16. Any other job as necessary.
17. Have your vehicle checked at any TVS Motor Company Authorised Distributor or Dealers / Authorised Service Centers.

Note

Ensure the first aid equipments are changed periodically based on the expiry.

Caution

Long journey are to be taken only after the running-in period of 1000 km.

SERVICE RECORD

| S.No. | Description | Odometer reading | Job card no. / Date | Servicing Dealer's stamp and sign. |
|-------|--|------------------|---------------------|------------------------------------|
| 1 | 1st service between (a) 500 - 750 km or (b) 1 month from the date of purchase, whichever of the two occurs earlier. | | | |
| 2 | 2nd service between (a) 2500 - 3000 km or (b) 3 months from the date of purchase, whichever of the two occurs earlier. | | | |
| 3 | 3rd service between (a) 5000 - 6000 km or (b) 6 months from the date of purchase, whichever of the two occurs earlier. | | | |
| 4 | 4th service between (a) 8500 - 9000 km or (b) 9 months from the date of purchase, whichever of the two occurs earlier. | | | |

SERVICE RECORD

| S.No. | Description | Odometer reading | Job card no. / Date | Servicing Dealer's stamp and sign. |
|-------|---|------------------|---------------------|------------------------------------|
| 5 | 5th service between (a) 11500 - 12000 km or (b) 12 months from the date of purchase, whichever of the two occurs earlier. | | | |
| 6 | 6th service between (a) 14500 - 15000 km or (b) 15 months from the date of purchase, whichever of the two occurs earlier. | | | |
| 7 | 7th service between (a) 17500 - 18000 km or (b) 18 months from the date of purchase, whichever of the two occurs earlier. | | | |
| 8 | 8th service between (a) 20500 - 21000 km or (b) 21 months from the date of purchase, whichever of the two occurs earlier. | | | |

SERVICE RECORD

| S.No. | Description | Odometer reading | Job card no. / Date | Servicing Dealer's stamp and sign. |
|-------|--|------------------|---------------------|------------------------------------|
| 9 | 9th service between (a) 23500 - 24000 km or (b) 24 months from the date of purchase, whichever of the two occurs earlier. | | | |
| 10 | 10th service between (a) 26500 - 27000 km or (b) 27 months from the date of purchase, whichever of the two occurs earlier. | | | |
| 11 | 11th service between (a) 29500 - 30000 km or (b) 30 months from the date of purchase, whichever of the two occurs earlier. | | | |

MANUFACTURER : TVS MOTOR COMPANY LIMITED
P.B. No1, Bythahalli, Kadakola post, Mysore - 571 311, India.

ENGINE

Type : 4 stroke, Oil cooled, single cylinder OHC, EFI

Cylinder bore : 66 mm

Stroke : 57.8 mm

Piston displacement : 197.75 cc

Compression ratio : 10.0 ± 0.5 : 1

Air filter : Viscous Paper filter

Oil filter : Wire mesh and micronic paper filter

Lubrication system : Forced wet sump

Maximum power in

 Sport mode : 15.32 kW @ 9000 rpm

 Urban and Rain mode : 12.74 kW @ 7800 rpm

Maximum torque in

 Sport mode : 17.25 Nm @ 7250 rpm

 Urban and Rain mode : 16.51 Nm @ 5750 rpm

Maximum speed in

 Sport mode : 127 km/h in 5th gear

 Urban and Rain mode : 105 km/h in 5th gear

ENGINE

Engine idling rpm* in

 Sport mode : 1650 ± 200 rpm

 Urban and Rain mode : 1450 ± 200 rpm

Starting system : Electric starter

Emission norms : BS VI

TRANSMISSION

Clutch : Wet - multiplate type

Gear shift pattern : 1 down and 4 up

Primary transmission : Helical gears

Secondary transmission : Chain and sprockets

GEAR RATIOS

I gear : 2.917

II gear : 1.857

III gear : 1.333

IV gear : 1.050

V gear : 0.880

Primary reduction : 2.818

Final reduction : 3.461

* Under warm condition

CHASSIS

| | |
|---|---|
| Overall length | : 2020 mm (without mud flap) |
| | : 2050 mm (with mud flap) |
| Overall width | : 790 mm |
| Overall height | : 1050 mm |
| Seat height | : 800 mm |
| Ground clearance | : 180 mm |
| Wheel base | : 1353 mm |
| Kerb weight (with toolkit and 90% of fuel) | : 152 kg |
| Pay load | : 130 kg |
| Maximum laden weight | : 282 kg |
| Steering angle | : 35° |
| Caster angle | : 25.8° |
| Frame | : Double Cradle Split Synchro STIFF (DCSSS) |
| Front suspension | : Telescopic oil damped |
| Rear suspension | : Gas charged Mono shock absorber, 7 step adjustable with rectangular swing arm |
| Trail length | : 95.5 mm |

TYRE***Tyre size**

| | |
|-------|--|
| Front | : 90/90 - 17 49P Tubeless |
| Rear | : 130/70 R17 M/C 62P Tubeless (Radial tyre) |

Tyre pressure

| | |
|-------------|------------------------------------|
| Front | : 1.75 kg/cm ² (25 PSI) |
| Rear - solo | : 2.00 kg/cm ² (28 PSI) |
| Rear - dual | : 2.25 kg/cm ² (32 PSI) |

BRAKES

| | |
|-------|---------------------------------------|
| Front | : Hand operated, 270 mm petal disc |
| Rear | : Foot operated, 240 mm petal disc |

* *The pneumatic tyres fitted in this vehicle meet the requirements specified by BIS and comply with the requirements under the Central Motor Vehicles Rules (CMVR), 1989.*

ELECTRICAL

| | |
|-------------------|-----------------------------------|
| Type | : AC generator |
| Ignition system | : ECU -3D Ignition timing map |
| Spark plug | : BOSCH - UR4KE |
| Spark Plug gap | : 0.8 to 0.9 mm |
| Battery type | : VRLA |
| Battery capacity | : 12V, 8Ah |
| Generator | : Fly wheel magneto 12V, 300W |
| Head lamp | : 12V, LED Headlamp |
| Position lamp | : LED lamps (12V, 3Wx2) |
| Tail / brake lamp | : LED lamps (1W max. / 2.5W max.) |
| Turn signal lamp | : 12V, 10W x 4 |
| Number plate lamp | : 12V, 5W x 1 |
| Instrument panel | : LCD / LED indicators |
| Horn | : 12V, DC x 2 |
| Fuse | : 12V, 25A x 1 (main fuse) |
| | : 12V, 20A x 1 (ABS fuse) |
| | : 12V, 15A x 1 (DC load fuse) |
| | : 12V, 10A x 1 (EMS fuse) |

Caution

Using the bulb other than the specified rating can result in overloading of the electrical system or premature failure of the bulb.

CAPACITIES

| | |
|-------------------------|--|
| Fuel tank capacity # | : 12 litres (including reserve) |
| Fuel | : BS VI / Unleaded Petrol with minimum RON 91 |
| Engine cum transmission | : T V S T R U 4 F U L L Y SYNTHETIC oil |
| Oil grade | (SAE 10W30 API-SL, JASO MA2) |
| Engine cum transmission | : 1200 ml (during servicing) |
| oil and capacity | 1400 ml (during engine overhaul) |
| Front fork oil grade | : KYB G10 oil |
| Front fork oil capacity | : 329 ± 2 ml / leg |
| Brake fluid | : TVS Girling DOT 3 / DOT 4 |

Note

Ensure the first aid equipments are changed periodically based on the expiry.

The fuel tank is not a measuring instrument and the capacity of fuel tank may slightly vary from the indicated capacity.