

TVS *Racing*

TVS 



Owner's Manual

Apache
RTR 160 4V
RACING DNA UNLEASHED

1755 PS POWER | DUAL CHANNEL ABS | 3 RIDE MODES



SCAN FOR 24X7
ROADSIDE ASSISTANCE NOW

**WE GO THE DISTANCE
WHEN IT COMES
TO YOUR ASSISTANCE.**

MAKE YOUR RIDES HASSLE-FREE AND STRESS-FREE
WITH SERVICE BEYOND JUST ASSISTANCE.

Sign up for our 24X7 Roadside Assistance and enjoy
quick and efficient service anytime, anywhere.





Drive In.

Drive Out.



**Say bye-bye to waiting time
for servicing your bike.**

Get your vehicle serviced in 1 hour at no additional cost. Contact your nearest Dealership for details.†

† Facility available at selected Dealerships only. Terms and conditions apply





Busy Life? Easy Servicing!

Now, service your bike anywhere, anytime.

- ★ Service the vehicle at your door step.
- ★ Available for regular maintenance or breakdown service only.
- ★ Offered at nominal convenience charges.

Contact your nearest Dealership for details.[†]

[†] Facility available at selected Dealerships only. Terms and conditions apply





Busy Life? Easy Servicing!

Now, service your bike anywhere, anytime.

- ★ Service the vehicle at your door step.
- ★ Available for regular maintenance or breakdown service only.
- ★ Offered at nominal convenience charges.

Contact your nearest Dealership for details.[†]

[†] Facility available at selected Dealerships only. Terms and conditions apply

EXPRESS SERVICE	I
EXPERT ON WHEELS	II
PICKUP AND DROP	III
CONTACT(S) FOR SUPPORT	1
FOREWORD	5
SAFETY INFORMATION	9
NOTICE	10
RUNNING-IN INFORMATION	11
ANTI-LOCK BRAKING SYSTEM	12
SAFE RIDING TIPS	17
KNOW YOUR TVS APACHE RTR 160 4V	21
RIDING YOUR TVS APACHE RTR 160 4V	80
MAINTENANCE	86
WARRANTY AND SERVICES	113
SERVICE INFORMATION	117
TECHNICAL SPECIFICATIONS	120
GENERAL INFORMATION	126

Incase you need any clarification please contact

TVS Motor Company Authorised Main Dealer / Authorised Dealer

Or

TVS Motor Company's Area Offices (flip over for addresses)

Or

Toll Free Number : 1800-258-7111

Email : customercare@tvsmotor.com

Disclaimer : TVS Motor Company or any of its officials / Authorized Main dealer / Authorized Dealer do not ask customers for bank / card / wallet details / authentication. In case you face any such claim, please report to the relevant local authorities immediately.

CONTACT AT OUR AREA OFFICES

TAMILNADU-1 & 3

1. TVS Motor Company Limited

V Floor, Gee Gee Universal,
No. 2, MC Nichols Road,
Chetpet, Chennai - 600 031.
Phone : 044-28361651/28361654
Email : AO.Chennai@tvsmotor.com
AO.Madurai@tvsmotor.com

TAMILNADU-2

2. TVS Motor Company Limited

No. 10, 2nd floor,
Shree Shanmugapriya Towers,
Kannuswamy Street,
Behind Hotel Annapoorna,
R S Puram, Coimbatore - 641 002.
Phone : 0422-4350060/2541035
Email : AO.Coimbatore@tvsmotor.com

KERALA

3. TVS Motor Company Limited

Ambady Towers, Second Floor,
Door No. 27/631, A6,
Edappally-Pookkattupady Road,
Edappally PO., Cochin - 682 024.
Phone : 0484-2544578/2556938
Email : AO.Cochin@tvsmotor.com

KARNATAKA-1 & 2

4. TVS Motor Company Limited

No. 600, Anand Surya, 2nd Floor,
15th Cross, 6th Phase, JP Nagar,
Opp. BMTC Bus Stop,
Bangalore - 560 078.
Phone : 080-26653433
Email : AO.Bangalore@tvsmotor.com

ANDHRAPRADESH & TELANGANA

5. TVS Motor Company Limited

Rukmani Towers, First Floor,
No. 3-11-30, Plot No. 11,
Paigha Colony, Behind Anand Theater,
Secunderabad - 500 003.
Phone : 040-27840590/27844419
Email : AO.Hyderabad@tvsmotor.com

MAHARASHTRA-1 & 2

6. TVS Motor Company Limited

No. 401, 4th Floor, The Chambers,
Plot No. 4/12/3, Near Ganapati Chowk,
Viman Nagar, Pune - 411 014.
Phone : 020-26632112/26632110
Email : Service.pune@tvsmotor.com

MAHARASHTRA-3

7. TVS Motor Company Limited

No. 502B, 6th Floor, B Wing,
Shriram Shyam Towers,
Near LIC Square, Sardar,
Nagpur - 440 001.
Phone : 0712-2569932
Email : Service.Nagpur@tvsmotor.com

CHATTISGARH

8. TVS Motor Company Limited

Office No. 526, 527 & 528,
Magneto Offizo,
5th Floor, Magneto The Mall,
Labhandi, NH-6, Raipur - 492 001.
Phone : 0771-4260006
Email : AO.Raipur@tvsmotor.com

GUJARAT

9. TVS Motor Company Limited

1208-1213, Shivalik Satyamev,
Below Bopal Over Bridge,
Ambli-SP Ring Road Junction, Bopal,
Ahmedabad- 380 058.
Phone : 079-65443748
Email : AO.Ahmedabad@tvsmotor.com

MADHYA PRADESH-1 & 2**10. TVS Motor Company Limited**

No. 211-212, 2nd Floor,
Chinar Incube Business Centre,
Chinar Fortune City,
Near Brindhavan Dhaba,
Hosangabad Road,
Bhopal - 462 026.
Phone : 0755-2499406/2499306
Email : AO.Bhopal@tvsmotor.com
AO.Indore@tvsmotor.com

RAJASTHAN-1 & 2**11. TVS Motor Company Limited**

Plot No. 17-18,
2nd Floor of National Motors Building,
Jhotwara Industrial Area,
Jaipur - 302 012.
Phone : 0141-5150901/5150902
Email : AO.Jaipur@tvsmotor.com
AO.Udaipur@tvsmotor.com

DELHI & HARYANA**12. TVS Motor Company Limited**

D-3 & D-4, 2nd Floor,
Sector - 10, Noida,
Uttar Pradesh - 201 301.
Phone : 011-29834640/29834773
Email : AO.Delhi@tvsmotor.com

PUNJAB & CHANDIGARH**13. TVS Motor Company Limited**

4th Floor, Royal Business Park,
Chandigarh Ambala Highway,
Zirkapur - 140 603.
Phone : 01762-464777/465777
Email : AO.Chandigarh@tvsmotor.com

UTTAR PRADESH WEST & HILLS**14. TVS Motor Company Limited**

D-3 & D-4, 2nd Floor,
Sector - 10, Noida,
Uttar Pradesh - 201 301.
Phone : 011-29834640/29834773
Email : AO.Delhi@tvsmotor.com

UTTAR PRADESH CENTRAL & EAST**15. TVS Motor Company Limited**

1st Floor, Cyber Tower, TC-34/V-2,
Vibhuti Khand, Gomti Nagar,
Lucknow - 226 010.
Phone : 0522-4918300/4918301
Email : AO.Lucknow@tvsmotor.com

WEST BENGAL**16. TVS Motor Company Limited**

Ground Floor & First Floor,
133 A. S. P. Mukherjee Road,
Opp. Tollygunge Police Station,
Kolkatta - 700 026.
Phone : 033-24617096/24617092
Email : AO.Kolkatta@tvsmotor.com

BIHAR**17. TVS Motor Company Limited**

N-Plaza, Jamal Road,
P.S. Kotwali,
Patna - 800 001.
Phone : 0612-2200068/2200069
Email : AO.BNJ@tvsmotor.com

ORISSA**18. TVS Motor Company Limited**

No. 303, 3rd Floor,
Creative Plaza, Rasulgarh,
Bhubaneswar - 751 010.
Phone : 0674-2580019
Email : AO.Bhubaneswar@tvsmotor.com

JHARKHAND

19. TVS Motor Company Limited

Second Floor, Lucas Service Building,
Argora Bypass Road,
Ranchi - 834 002.
Phone : 0651-2244715
Email : AO.Ranchi@tvsmotor.com

NORTH EAST STATES

20. TVS Motor Company Limited

147, Udayan, Ganesh Guri,
Near Hotel D Courtyard,
R G B. Road, Guwahati - 781 005.
Phone : 0361-2202030/2202031
Email : AO.Guwahati@tvsmotor.com

Dear Racer,

Thank you for choosing the TVS Apache RTR 160 4V.

“The TVS Apache RTR 160 4V has constantly pushed the limits of performance with best-in-class 17.55 PS power alongside segment-first features like 3 ride modes (Sport, Urban and Rain) and TVS SmartXonnect technology, which provides features like Call/SMS alerts, Navigation, Low fuel warning and more. Combined with Glide Through Technology (GTT) for smooth low speed control, it delivers superior performance along with unmatched ride & handling, making it a machine engineered to surge to the lead.

Power is nothing without control, the Apache RTR 160 4V, equipped with Dual-Channel ABS, offers sharp braking, and instils the utmost confidence, enabling riders to brake later and attack corners with precision. The race machine now comes with 37 mm Upside Down (USD) Suspension provides quicker response, enhanced handling, and improved ride comfort. The USD suspension delivers greater stability on straights and improved agility in corners, boosting rider confidence.

Complementing its performance enhancements, the new Apache RTR 160 4V also features refreshed and sportier race graphics, premium gold-finished front forks, and coloured alloy wheels, elevating its aesthetic appeal.

Additionally, it is equipped with an LED headlamp and taillamp, a race-inspired digital cluster, and adjustable brake and clutch levers, making it a true race machine ready for any challenge.”

This manual explains the features and operations of your TVS Apache RTR 160 4V. Please read it carefully and follow the instructions to enjoy the ultimate racing experience.

To prolong your journey on the TVS Apache RTR 160 4V, we urge you to get your TVS Apache RTR 160 4V serviced only at TVS Motor Company Dealers or Authorised Dealers.

TVS MOTOR COMPANY LIMITED

Brand Experience

Live the pure performance life.

Since 2005, TVS Apache has been at the helm of performance motorcycling, creating an entirely new breed of racers. And now that you have chosen the ultimate race machine, you are also part of this esteemed legacy. Not just that, you are also standing at the portal to a 360 moto-experience encompassing from out riding your limits at the racetrack to becoming part of a league of riders who share your passion for motorcycling.

Apache Owners Group

Join the league of Apache motor enthusiasts that share your passion for riding. Explore the uncharted, tame every terrain, forge unbreakable bonds, and make unforgettable memories with every journey.

Go on thrilling rides all year round –

Breakfast ride | Overnight ride | Marquee ride | Chapter ride

Apache Racing Experience

If you have the mettle, we have the track. Apache Racing Experience (ARE), a flagship property of TVS Racing & Apache, is the embodiment of our philosophy, **“the bikes we race are the bikes we sell.”** Hone your racing skills and techniques with the INMRC Champion riders from TVS Racing and test the limits of your machine and yourself.

TVS Racing Training School

Founded in 2017, TVS Racing Training School aims at fostering motor sports in India. We believe that all our riders are racers at heart and here, they can unleash that racer and learn the skills under National Champions. And through multiple levels of training, we hope to turn these racing zealots into the podium winners of tomorrow.

Join the AOG community - <https://www.tvsapache.com/assets/pdf/AOG-Regulations.pdf> and also download the TVS Connect app / <https://www.tvsapache.com/aog.aspx>



PERFORMANCE GEAR

When you ride your performance machine, you need to have gear that performs too. That's why we have TVS Racing Performance Gear – an entire range of riding gear designed to offer you the ultimate riding experience. With utmost safety and extreme comfort, it lets you take on every terrain and any weather.

With the range of urban wear, you can wear your passion even off track. And the racing DNA woven in is all you need to get your podium look on.

Riding Jackets & Pants | Helmets | Riding Boots | Riding Gloves
Polo T-Shirts | Caps | Sunglasses | Backpacks

To know more log on to -
<https://accessories.tvsmotor.com/performance-gear.aspx>



OUR RACING HERITAGE IS NOW YOURS TO TAKE FORWARD

Your TVS Apache is born of the legacy of TVS Racing



<p>◀ 1982 ▶</p> <p>Our love of racing began when a TVS 50 Moped clocked 105 km/h.</p>	<p>◀ 1988/89 ▶</p>  <p>AX 100 won the Great Himalayan Desert Rally.</p>	 <p>◀ 2005 - Till date ▶</p> <p>TVS Apache RTR was launched. It started a revolution in racing and continues to dominate with 90% of race wins and multiple national championships.</p>	<p>◀ 2017 ▶</p>  <p>TVS Racing wins their 18th Championship title</p>	 <p>◀ 2018 ▶</p> <p>TVS Racing wins their 7th consecutive INMRC title</p>
 <p>◀ 1992/93 ▶</p> <p>Supra won Indian the National Rally Championship; Special Rally kit 250 numbers were made and sold.</p>	<p>◀ 1993/94 ▶</p>  <p>Shogun kicked off scheme bike racing in India.</p>	 <p>◀ 2011 ▶</p> <p>TVS Racing won SLADA and Sri Lanka National Championship in 2011, 2016 and 2017.</p>	<p>◀ 2007 ▶</p>  <p>Won 12 national championships Supercross, Motocross and Rally.</p>	 <p>◀ 2019 ▶</p> <p>Finished the Dakar Rally in 12th place and won the INMRC, INRC and INSC.</p>
 <p>◀ 1998 ▶</p> <p>Shaolin won the Indian National Rally and Supercross Championships.</p>	 <p>◀ 1998 ▶</p> <p>Fiero won multiple Indian National Rally, Supercross and Road Racing championships.</p>	 <p>◀ 2016 ▶</p> <p>First factory team in India to sign a woman rider and launch a dedicated road racing cup for women.</p>	<p>◀ 2015 ▶</p>  <p>TVS leaves its mark as the 1st Indian Manufacturer in Dakar.</p>	 <p>◀ 2020 ▶</p> <p>Finished on the title and debuted in (250 cc production category)</p>
<p>◀ 2017 ▶</p>  <p>The RTR 160 wins 6 consecutive INMRC titles.</p>				

Keep up with our pace. Follow TVS Racing on -



Operating this vehicle safely is an important responsibility of the rider. To help you make decisions on safety, we have provided necessary operating procedure and other information in the owner's manual. This information alerts you on potential hazards that could hurt you or others. Since it is not possible to warn you about all the hazards associated with operating or maintaining the vehicle, you must use your own judgement.

You will find important safety information in following form in this manual. These words carry the following connotations:

 **Warning**

*Disregarding this message might result in **injury to the rider or deadly accidents.***

 **Caution**

*This message indicates special procedures or precautions to be followed to **avoid damage to the vehicle.***

 **Note**

*This message provides further clarification for **clear understanding of any particular information.***

Take time to familiarize yourself with your TVS APACHE RTR 160 4V and its performance characteristics.

This Owner's Manual contains a host of useful information. Please take the time to read this manual before you ride your new TVS APACHE RTR 160 4V. Get familiarised with the operation of your motorcycle for maximum safety and pleasure. The better you know your vehicle, the more pleasure you will experience riding your new vehicle. Ensure that anyone else riding your TVS APACHE RTR 160 4V does the same.

All information, illustrations, photographs and specifications contained in this owner's manual are based on the latest product information available at the time of this publication. TVS Motor Company Limited may, however, incorporate modifications or improvements on its vehicles at any time without notice, and therefore, in such events it is possible that the relevant part of the owner's manual does not apply to your vehicle.

Prior permission of TVS Motor Company Limited is required for quoting, copying or reproducing any part of this owner's manual.

Note

Accessories shown in the picture may not be a part of standard equipment.

Your motorcycle is provided with a day time running lamp (DRL). The DRL glows automatically once the ignition is turned 'ON' and goes dim on switching on the head lamp while the engine is running.

Since your vehicle is fitted with side stand cut-off system ensure to retract the side stand before starting / moving the vehicle.



The first 1000 km is a crucial part of your motorcycle. Proper running-in operation during this period helps in ensuring a **maximum life** and **smooth performance** of your motorcycle.

The reliability and performance of your motorcycle depends on the special care and restraint exercised during the running-in period. It is especially important that you avoid operating the engine in high speed (RPM), which could expose the engine parts to excessive stress. Recommended speed during the running-in is:

Maximum 50 kmph speed upto 750 km (vary the engine speed for better mating of parts).

The first free service at 500 ~ 750 km is most important. During running-in period all the engine components and other parts will have set in. All adjustments to be restored, all fasteners to be tightened. Engine cum transmission oil to be replaced. Timely performance of the first free service will ensure optimum service life and performance from the engine.



Caution

Replacing the engine cum transmission oil during first service is most important for better life of engine. Always use TVS TRU4 FULLY SYNTHETIC oil (SAE 10W30 API-SL, JASO MA2) for better performance and life.

*Since your motorcycle is fitted with Evaporative Emission Control System, **the motorcycle should not be laid on the floor during water wash.** Else it may lead to difficulty in starting and improper running of the motorcycle.*

ANTI-LOCK BRAKE SYSTEM (ABS)

Your motorcycle is fitted with an **Anti-Lock Braking System (ABS)** which is designed to prevent skidding and help riders to maintain steering control during emergency-stopping situation in dry or wet roads, loose gravels etc. In case of single channel ABS system, the ABS system is provided only on the front brake whereas in dual channel system has the ABS system on both front and rear brakes.

How does ABS work?

When a rider applies the front brake (in single channel system) or any of the brake (in dual channel system) continuously, as he detects a dangerous obstacle in dry or wet roads, loose gravels etc. transmits an excessive brake force to the wheel. This excessive force may cause the wheels to stop spinning and leads to lose of road grip. With no firm contact between the tire's contact patch and the road surface, the bike becomes unstable and a crash is imminent.

The slipping wheels on a riding surface results in losing control of whole motorcycle which usually occurs in fractions of a second. Restoring traction while keeping the bike balanced is only a result of luck, or extreme training, as is the case of professional stunt riders who drift. Preventing the wheels from slipping due to excessive braking force compensates losing control and help the rider to maneuver the vehicle and to avoid accidents.

So what the ABS does is actually limiting the braking force exerted by the rider by either squeezing the lever and keep the wheel spinning. Once the imminence of the locking (and therefore skidding) is avoided, the system re-applies the maximum braking force until the next skid is anticipated. By limiting the max force of the braking maneuver, the ABS systems practically allow the riders to use the greatest stopping force possible without locking the wheels.

How does the ABS understands the wheel locking?

The ABS uses continuous wheel speed monitoring system; wheel speed sensors and toner rings and a Hydraulic Electronic Control Unit (HECU).

During normal operation the ABS works similar to a normal brake. The speed sensors fitted on the both the wheels (in case of dual channel ABS) measures the rotational speed of the wheels, when the wheel speed reduces rapidly i.e. wheel tends to lock, the HECU modulates the pressure in the brake circuit and thereby prevents the wheel from locking.



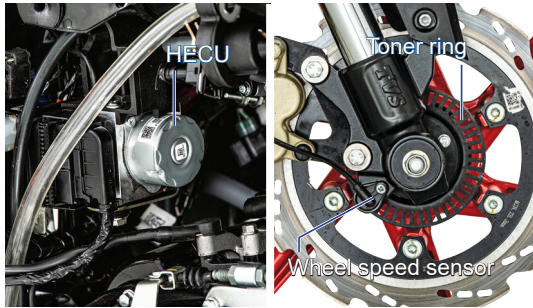

How the irregular road surface affects the braking?

Humps and irregular surfaces of the road can cause the wheels to lose contact temporarily with the road surface; if this happens the braking force that can be transmitted to road surface is zero.

If the brakes are applied under these condition, the ABS has to reduce the braking force to ensure and maintain the directional stability when the wheels regains its contact with the road surface. At this instant the ABS must reduce the traction, so that the wheels will continue to rotate under all imaginable circumstances, because this is the precondition for ensuring directional stability.

As soon as the actual circumstances arises, the system reacts instantly and adjusts braking force accordingly to achieve optimum braking.

Why does brake pedal / lever pulsate during brake application?

Vehicles fitted with ABS uses the conventional brake system during normal operation. **But during hard stop the brake pedal / lever feels different, i.e., a rapid pulsation in the brake pedal / lever; This is absolutely normal.**

It is not necessary to have this pulsation feel every time the brake is applied. Pulsations are felt only during wheel locking tendency, occurs due to the modulation of pressure in the brake circuit by HECU. Pulsation means that the vehicle is in limit. This pulsation feel also depends on the road condition.

Rear wheel lift

Under very severe and sudden deceleration, however, under certain circumstances it is possible that the ABS unit fitted in your vehicle will be unable to prevent the rear wheel from lifting clear of the ground and flip over. Severe braking can cause the rear wheel to lift off the ground.

When you brake, bear in mind that ABS control cannot always be relied on to prevent the rear wheel from lifting clear of ground.

Warning

The ABS can apply and release the pressure in the brake circuit much faster than that rider can do with brake lever / pedal to avoid wheel locking. So there is no need to pump the brake, it requires only continuous application.

Incase of single channel ABS system, only the front brake of your motorcycle is fitted with ABS system and not the rear brake. Applying rear brake alone can cause wheel skidding just like normal braking system incase of single channel ABS system. Always apply both front and rear brake for better performance.

ABS warning lamp

The TVS Apache RTR 160 4V does an automatic self check every time when the ignition switch is turned 'ON'. The ABS warning lamp provided at the speedometer console blinks and informs you that the ABS is under check.

This ABS warning lamp goes 'OFF' once the bike speed reaches 10 km/h and blinks whenever the speed is less than 10 km/h indicating that the ABS is working fine.

If the warning lamp glows continuously even after the bike crossing the specified speed limits. Then the ABS has an error and your bike should be taken to any of our nearest TVS Motor Company Authorised Main Dealer / Authorised Dealer.



DO'S AND DON'TS

Do's

- ◆ Check the ABS warning lamp for any warning before driving the vehicle.
- ◆ Apply both front and rear brake for better performance.
- ◆ Apply continuous brake in ABS mode for better performance. Do not pump.
- ◆ Perform the periodic maintenance as per the schedule.
- ◆ ABS should be serviced only at TVS Motor Company Authorised Main Dealer / Authorised Dealer.
- ◆ Carefully remove the front wheel during puncture / tyre replacement to prevent toner ring damage / bend.
- ◆ **Keep the wheel in such a way that the toner ring is facing upwards.**
- ◆ Always use recommended brake fluid. Use fresh, clean brake fluid.
- ◆ Use only the recommended make, type and size of tyre (ABS tuned with tyre specified by the TVS Motor Company).

Don'ts

- ◆ Do not use **non-standard tyres.**
- ◆ Do not pump the brakes. Apply the brakes continuously.
- ◆ Do not ignore any warning lamp on speedometer.
- ◆ Do not adjust the wheel speed sensor air gap your self.
- ◆ Do not run the engine and ride or rotate the rear wheel alone in gear with vehicle on centre stand, for drive chain lubrication, during water wash etc.,
- ◆ Do not attempt to correct the toner ring teeth by bending manually or by using any other method.

Warning

ABS only helps in improving the vehicle control. It is always good to remember not to exceed the physical limits of the vehicle stability. It is rider's responsibility to ride at a suitable speed, while taking care of conditions and road surface. ABS will not compensate for errors in the judgment or improper brake use in the various situation. ABS never eliminates the danger of falling while turning.

Hard braking during sharp cornering on slippery surface may lead to vehicle instability. Under such circumstances gradual braking is recommended.

- ◆ Do not use different toner ring.
- ◆ Do not insert any metallic parts near wheel speed sensor.
- ◆ Do not test the ABS on road!!, but use ABS (it is already tested).

Note

Incase of ABS failure, the braking system will work like a non ABS braking system and provides normal stopping distance.

This motorcycle is equipped with ABS on front wheel. For repair or replacement of tyres (tubeless) please contact nearest TVS Motor Company Authorised Main Dealer / Authorised Dealer.

As a general riding practice it is advisable to apply more front brake and less of rear brake.

Use of non-genuine brake pads, tyres, disc etc. leads to poor braking performance and unsafe riding conditions.

Never open HECU on your own, it is a very sensitive part of ABS and needs to be handled only by the trained personnel. Contact your nearest TVS Motor Company Authorised Main Dealer / Authorised Dealer.

- ◆ **Do not use non-genuine spares like pads, discs, tyres etc.**
- ◆ Do not try to service HECU or open to separate parts.
- ◆ Do not disengage the ABS by removing the ABS coupler.

Warning

Do not ride the vehicle in conditions like wheelie, stoppie, on-stand engine revving in gear for chain lubrication and during water wash etc... for more than three minutes as it will result in ABS error and ABS warning lamp glowing continuously. In such cases, just switch 'OFF' and switch 'ON' the ignition key once. ABS warning lamp may glow continuously if any ABS error had occurred before.

This error gets cleared automatically and ABS warning lamp goes 'OFF' after riding the vehicle above 6 km/h speed. If the ABS warning lamp is still 'ON', then contact the nearest TVS Motor Company Authorised Main Dealer / Authorised Dealer (applicable only for dual channel ABS system).

SAFE RIDING RECOMMENDATIONS

Any two wheeler riding requires some precautions to be taken to ensure the safety of the rider, pillion and other road users. These precautions are:

Familiarise yourself with new TVS Apache RTR 160 4V

Riding skill and your mechanical knowledge form the foundation of safe riding practices. We suggest you to practice riding TVS Apache RTR 160 4V in a low-traffic condition until you are thoroughly familiar with your vehicle and its controls. Remember practice makes you perfect.

Riding apparel

Loose, fancy clothing can be uncomfortable and unsafe when riding a two-wheeler. Choose good quality two wheeler riding apparel.

Know your limits

Ride within the boundaries of your own skill at all times. Knowing these limits and staying within them will help you to avoid accidents.

Warning

Two wheeler safety starts with wearing a good quality helmet. *One of the most serious injuries that can happen is a head injury. Always wear an ISI approved helmet that should fit your head comfortably and securely. You should also have good quality goggles to protect your eyes and help your vision.*

To prevent or minimize accident, never consume alcohol or drugs before or during the operation of your vehicle. Even minimal consumption of these will affect the rider's ability to control the vehicle.

Posture

Proper vehicle riding starts with proper posture.

1. Sit erect on the seat at the position which you feel most comfortable.
2. Keep your arms relaxed to give extra cushion for body on uneven road surfaces.
3. Keep right arm and foot close to the brake lever and pedal, so as to enable fast action during panic braking.

Warning

One-hand riding is dangerous. *Keep both hands firmly on the handle bar and both feet securely on the foot rest. Under no circumstances should both the hands be removed from the handle bar, as it is very dangerous.*

Avoid use of mobile phones while riding as it could lead to fatal accident.

Do not downshift the gears in the midst of cornering. Slow down to a safe speed before negotiating a corner. If this is the first time that you are riding a vehicle of this type, we suggest that you practice on a safe, open area to thoroughly familiarise with the operation of the vehicle.

4. Look widely instead of gazing at one point.
5. Alter your sitting location / posture slightly at intervals during long rides. This will reduce fatigue.

Cornering

When cornering, centrifugal force works in a direction perpendicular to the direction in which the vehicle is moving. Centrifugal force increases in proportion with speed and the radius of the corner.

During cornering, reduce speed so as to reduce the effects of centrifugal force. By all means, avoid abrupt application of brake or sudden steering.

Braking

For safe riding, it is very important to master the braking techniques.

1. Close / release the throttle.
2. Hold the vehicle upright as you apply the brake.
3. Progressive application of brakes is safer.
4. Never declutch while braking at higher speeds.
5. **Apply both the brakes.**
6. Do not pump the brakes.

- Riding down hills, while cornering and wet roads, close the throttle and down shift the gear to take advantage of gearbox and engine which acts as an additional brake. This will avoid the loss of control over the vehicle due to over speed.

Causes for poor braking

- If the brake shoes / pads or drum / disc are worn out or if there is water or oil on them, sufficient friction does not develop and brakes do not work well.

Warning

As the vehicle speed increases, the stopping distance also increases progressively. Be sure that, you have sufficient distance between you and the vehicle or obstruction ahead of you.

Avoid directing the water jet directly towards brake drum / disc pads during water wash.

*Using only the front or rear brake is dangerous and can cause skidding and loss of control. **Apply both the brakes together and with great care on a wet road or other slippery surfaces.***

Any abrupt braking on slippery or irregular roads can cause loss of rider control.

- Even when the brake works normally, if the road surface is wet or the tyre surface is worn-out, tyres do not take a firm hold on the surface, increasing the stopping distance.
- Approximately 60% braking effect is from front brake. **Non-usage of front brake causes poor braking.**

ACCESSORY INSTALLATION AND SAFETY TIPS

Use extreme caution while selecting and installing the accessories for your motorcycle.

The addition of **unsuitable accessories can lead to unsafe operating conditions.** Your friendly Dealer will assist you in selecting quality accessories and installing them correctly.

While selecting the accessories, make sure the accessories **should not obstruct lighting, steerability, suspension level and ground clearance.** Please ensure that, if the tank cover is used, it is not getting en-trapped between fuel tank and fuel tank cap.

Additional electrical equipments is not acceptable as it will void the warranty terms of the vehicle.

EMISSION CONTROL

All the TVS vehicles are tested in the factory for optimum fuel efficiency and CO levels. If the vehicle needs any adjustments, please consult nearest TVS Motor Company Authorised Main Dealer / Authorised Dealer.

While adequate care is exercised at the factory to ensure that the emissions are within the limits, it is essential for the owner to always maintain the motorcycle in good condition by getting it periodically checked and serviced by TVS Motor Company Authorised Main Dealer / Authorised Dealer so that the emission and fuel consumption levels are maintained as per norms.

Crankcase emission control system

The engine of new TVS Apache RTR 160 4V is equipped with a closed crankcase system to prevent discharging crankcase emissions into the atmosphere. Blow-by gas is returned to the combustion chamber through the air cleaner and fuel system.

Evaporative Emission Control System

The TVS Apache RTR 160 4V is equipped with an evaporative emission control system which consists of a canister and associated piping. This system prevents the escape of fuel vapors from the fuel tank.

Warning

If there is any abnormal jerk, startability issue are felt in the vehicle or noise due to sudden escape of gas during opening of fuel tank cap, immediately report to the TVS Motor Company Authorised Main Dealer / Authorised Dealer.

Note

Your vehicle is tested and certified for emission which meets BS VI emission norms and is valid for initial 12 months from the date of purchase. Get your vehicle certified by the Government authorised emission testing station after initial 12 months of usage. And ensure to get the vehicle certified on expiry of the certificate obtained.

VEHICLE IDENTIFICATION NUMBER

The frame and engine serial numbers are the only means of identifying your vehicle from others of the same model and type. They are also required to assist your Dealer for ordering parts or referring to special information.



Frame serial number is engraved on the right side of the steering head tube as shown.



Engine serial number is engraved on the left side crankcase assembly near the cylinder block as shown.

LOCATION OF PARTS - HANDLE BAR

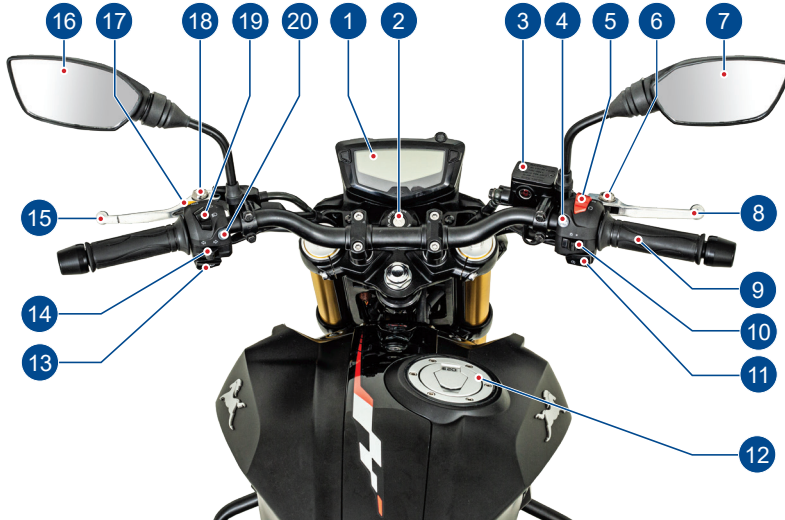

1. Instrument cluster
2. Ignition cum steering lock
3. Master cylinder (front)
4. Mode switch
5. Engine cut off switch
6. Front brake lever adjuster
7. Rear view mirror R
8. Front brake lever
9. Throttle grip
10. Head lamp switch
11. Electric starter switch
12. Fuel tank cap
13. Horn switch
14. Turn signal lamp switch
15. Clutch lever
16. Rear view mirror L
17. Pass by switch
18. Clutch lever adjuster
19. Beam control switch
20. Info switch

LOCATION OF PARTS - VEHICLE LEFT SIDE



1. Wheel hugger rear
2. Saree guard
3. Rear wheel axle
4. Pillion foot rest L
5. Rider foot rest L
6. Side stand
7. Center stand
8. Gear shift lever
9. Front wheel axle
10. Cover frame L

LOCATION OF PARTS - VEHICLE RIGHT SIDE



1. Disc plate front
2. Toner ring
3. Front wheel axle nut
4. Wheel speed sensor front
5. Caliper assembly front
6. Location of spark plug
7. Gauge oil level
8. Rear brake pedal
9. Rider foot rest R
10. Pillion foot rest R
11. Muffler assembly
12. Rear wheel axle nut
13. Disc plate rear
14. Caliper assembly rear
15. Cover frame R
16. Location of ram air duct

LOCATION OF PARTS - VEHICLE FRONT & REAR



FRONT

1. Turn signal lamp front L
2. LED Head lamp assembly with DRL / FPL
3. Oil cooler
4. Crash guard
5. Turn signal lamp front R

REAR

1. Pillion handle
2. Turn signal lamp rear R
3. Reflex reflector
4. Number plate lamp
5. Turn signal lamp rear L
6. Seat lock
7. Tail lamp assembly

License plates are mandatory accessory will be charged extra

CONTROL KEY

TVS Apache RTR 160 4V comes with a pair of identical control keys. These keys are to operate ignition cum steering lock, fuel tank cap and seat lock.

IGNITION CUM STEERING LOCK

The ignition cum steering lock enables and disables the electrical circuit and steering lock. There are three positions in the ignition cum steering lock. They are:

1. 'OFF' position

All electrical circuits are deactivated. The key can be removed from the lock.

2. 'ON' position

All electrical circuits are activated. The instrument cluster and warning lights performs self-diagnostic cycle. Engine can be started. Control key cannot be taken out from the lock.

Note

When the ignition is turned 'ON' with the engine kill switch 'ON', priming noise of pump may be heard which is absolutely normal.

Frequent switch 'OFF & ON' of ignition to be avoided. After ignition key reset, there may be a delay in start of vehicle for couple of seconds.

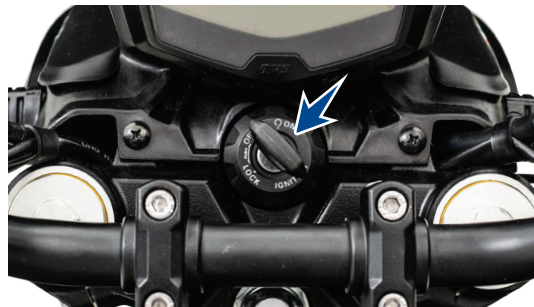

3. 'LOCK' position

TVS Apache RTR 160 4V's steering can be locked in both 'left' and 'right' directions. To lock the steering, turn the handlebar all the way to the 'left' or 'right' direction. Push the key 'IN' and turn it to the 'LOCK' position and take out. All the electrical circuits are turned 'OFF' in this position.

Insert the control key into the lock and push the key 'IN' and turn it to 'OFF' or 'ON' position to unlock the steering.

Warning

Never attempt to move the vehicle when the steering is locked, you may lose balance.

Caution

Before turning the ignition key to 'ON' position, ensure the availability of adequate fuel in the tank **to avoid dry run of fuel pump**. Fuel level always to be maintained above single bar. **Never run the fuel pump dry to avoid failure of fuel pump.**

Leaving the ignition cum steering lock in 'ON' position for a prolonged time will drain the battery when the vehicle is not in use. Switch 'OFF' and take the key out when the vehicle is not in use.

Note

Connected instrument cluster's background illumination, day running lamp (DRL) / front position lamp (FPL), tail lamp and number plate lamp glow automatically once the ignition is turned 'ON' without activating any other switch.

When the ignition switch is turned 'ON', a message 'GEAR UP' followed by a Race flag, Welcome message, Ride mode name and Average speed details will be displayed on the connected instrument cluster's display. Wait till the 'AVG. SPEED' details appears on the display.

Always lock the steering while parking for safety.

HANDLE BAR LEFT SIDE



1. Info switch

Info switch () is used to cancel a incoming call, to clear a notification on cluster display, to start / stop the 'LAP' in the lap timer mode, to accept / reject the nearest fuel location suggestion.

2. Horn switch

Press the switch () to blow horn. It is used to attract the attention of other road users in case of danger.

3. Turn signal lamp switch

Slide the turn signal lamp switch to left '  ' or right side '  ' to operate the respective turn signal lamps (LH/RH). Press the switch to turn 'OFF'.

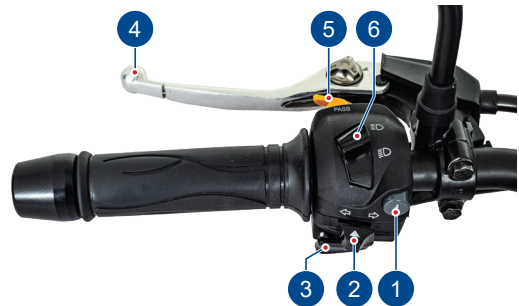

Warning

Failure to switch the turn signal lamp 'ON' or 'OFF' at the right time may lead to an accident.

4. Adjustable clutch lever

Use the clutch lever to disengage the drive to the rear wheel while shifting the gears. Squeezing the lever towards grip disengages the drive.

5. Pass-by switch

Press the switch to flash the head lamp high beam. It is used to give signal to the vehicles coming from the opposite direction while overtaking other vehicles during day.

The pass-by works only when the head lamp is glowing in low beam. If the switch is pressed while the head lamp is switched 'ON' and glowing in high beam, there will be no change in beam of head lamp.

Note

Pass by system will not work if the head lamp is glowing in 'High' beam.

Clutch lever position can be set to your convenience. Refer page no. 78 for details.

6. Beam control switch

The head lamp beam (high/low) can be controlled by pressing the beam control switch.

Press the switch towards '☰' to turn-on the head lamp high beam or press the switch towards '☷' to turn-on the head lamp low beam.

Warning

Use appropriate head lamp beam 'high / low' as per the traffic and road conditions for your safety and to avoid inconvenience to other riders.

Note

The head lamp glows in low beam when the head lamp switch is turned 'ON'. Only after the engine is started the head lamp high beam will work provided if the beam control switch is in high beam position.

HANDLE BAR RIGHT SIDE

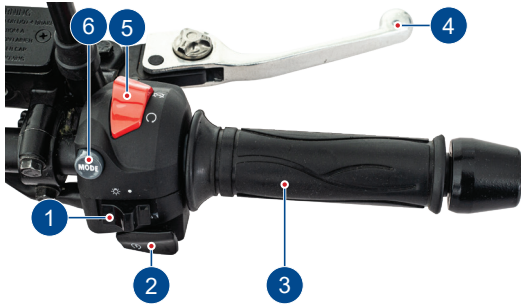

1. Head lamp switch

Head lamp switch has two positions. Working of switch at these positions are as followed:

OFF: The head lamp will be turned 'OFF' but other lamps like DRL, speedometer back illumination, tail lamp and number plate lamp glows when the switch is positioned at '●' position with ignition 'ON'.

ON: The head lamp low beam glows along with all other lamps when the switch is positioned at '☀' position with the ignition 'ON'. The headlamp high beam can be obtained only after starting the engine. The DRL will act as a FPL on switching 'ON' the head lamp.

Note

The DRL will act as a FPL once the headlamp is turned 'ON'.

2. Electric starter switch

Ensure the transmission is in neutral or else press the clutch lever and side stand is retracted before engaging the electric starter switch '⚡'.

3. Throttle grip

It controls the fuel-air mixture supplied to the engine, which regulates the engine speed. Rotate the throttle grip in counter-clockwise from its idle position to increase the engine speed and vice-versa to reduce.

Note

Ensure to turn 'ON' the engine cut-off switch before starting the vehicle. Release the electric starter switch immediately after pressing.

4. Adjustable front brake lever

It controls a hydraulic circuit (ABS) that operates the front brake system. The front brake is applied by pressing the front brake lever gently towards the grip. The brake lamp glows on application of front brake.

5. Engine cut off switch

It is used to switch off the engine but to keep other DC system active. If the switch is positioned at '  ', the ignition circuit will be disabled, preventing the engine from being restarted.

To restart the engine, return the switch to the '  ' position.

6. Mode switch

Press the mode switch to switch between 'Urban', 'Sport' and 'Rain' modes (refer page no. 41 for further details).

Note

When the ignition switch is turned 'ON' with the engine kill switch 'ON' condition, priming noise of fuel pump may be heard which is absolutely normal.

Frequent switch 'OFF' & 'ON' of ignition to be avoided to prevent unnecessary run of fuel pump.

Note

Front brake lever can be set to your convenience. Refer page no. 78 for details.

GEAR SHIFT LEVER

TVS Apache RTR 160 4V is equipped with a 5 speed constant mesh transmission. Neutral (N) position of the transmission is indicated by the warning light on the speedometer.

To shift the transmission from neutral to first gear, push the gear shift lever down.

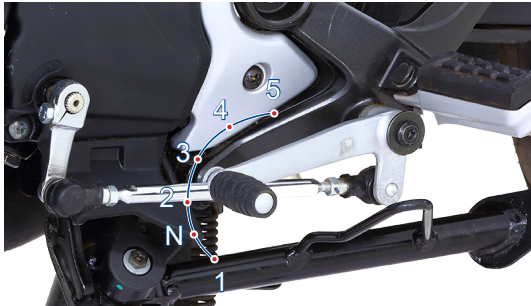

Caution

Never shift gears without disengaging the clutch and releasing the throttle. Failure to comply this will lead to rough shift or jerk while shifting the gears. Remember to return to neutral position before restarting the engine.

To change it to the second gear, lift the lever up. Lifting the lever up repeatedly engages all the gears in succession up to the fifth gear.

Note

Gear shift lever position can be set to your convenience. Contact your TVS Motor Company Authorised Main Dealer / Authorised Dealer for setting the gear shift lever position.

GLIDE THROUGH TECHNOLOGY (GTT)

GTT is a feature for low speed urban riding which enables an extremely smooth and controlled ride. With this feature, you can start moving the vehicle with a slow release of the clutch lever, without the throttle operation. This is a convenient feature while riding in heavy traffic. The requirement of the synchronization of the clutch lever and throttle grip is eliminated & engine stalling can be eliminated.

The maximum RPM with GTT feature without throttle.

Gear position	GTT RPM
1st Gear	1800 rpm
2nd Gear	1800 rpm
3rd Gear	2000 rpm
4th Gear	2400 rpm
5th Gear	2400 rpm



Caution

GTT is provided in all gears. However, GTT feature is mainly to be used in 1st, 2nd and 3rd gear. It is provided to assist the you to crawl in slow speeds. Care must be taken to control the vehicle if the GTT is used in 4th and 5th gear in traffic condition, as the GTT RPM is kept considerably high in 4th and 5th gear to avoid engine stall.



REAR BRAKE PEDAL

The rear brake pedal operates a hydraulic circuit that operates the rear brake system and it is located adjacent to the right side foot rest. To control the speed of your vehicle close the throttle completely and gradually press the brake pedal downwards.

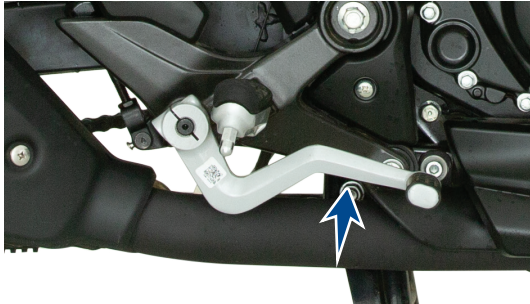

Note

Rear brake pedal position can be set to your convenience. Contact your TVS Motor Company Authorised Main Dealer / Authorised Dealer for setting the brake pedal position.

Caution

Independent use of rear or front brake reduces the overall braking efficiency. In extreme conditions braking with only rear or front brake may lock the wheel which would result in skidding or toppling of vehicle.

Braking performance is affected adversely with wet surfaces, loose surfaces and overheating of brake system due to unnecessary continuous application of brakes. For safety, exercise extreme caution while braking and also at turning. Do not accelerate while turning.

INSTRUMENT CLUSTER

Your TVS Apache RTR 160 4V is provided with a fully digital instrument cluster with lots of features and various modes.

The connected instrument cluster also has a mobile app for 'Smart Phones', navigation assist and voice assist etc. additionally along with other features.

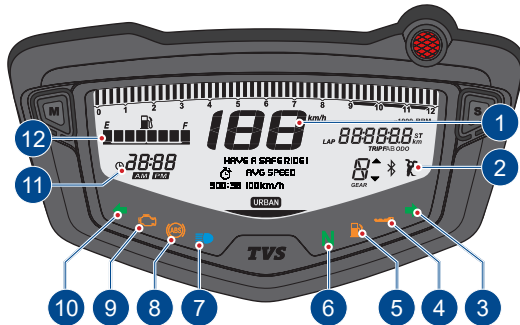

1. Speedometer

100 km/h

Indicates the vehicle speed in kilometer per hour by default whenever the ignition is turned 'ON'.

Note

If you leave the ignition key in 'ON' position and vehicle is kept in gear without moving for more than 3 minutes, an error message 'CHECK SPEED SENSOR' may scroll which is normal.

If you notice an error message 'CHECK SPEED SENSOR' while the vehicle is in move, Contact nearest TVS Motor Company Authorised Main Dealer / Authorised Dealer for rectification.

2. Side stand indicator ()

The side stand warning indicator turns 'ON' to alert you whenever the vehicle's side stand is deployed (vehicle in parked condition).

Note

In geared condition, if the side stand is deployed the vehicle will not start. In neutral condition, if the side stand is deployed the vehicle will start but as soon as the gear is engaged the vehicle will switch off.

If there is error in the side stand sensor the indication will blink and the vehicle will not start. In such a condition, please visit the nearest TVS Motor Company Authorised Main Dealer / Authorised Dealer.

3. Turn signal indicator right ()

Flashes when the right side turn signal indication is activated.

4. Immobilizer indicator ()

-NA-

5. Low fuel indication ()

Blinks when the fuel level reaches to minimum safe level. It glows continuously when the fuel comes down below minimum safe level.

6. Neutral indicator lamp (**N**)

Glows when the vehicle is in neutral and goes 'OFF' if the gear is shifted from neutral.

7. High beam indicator lamp ()

Glows when the head lamp is activated in high beam.

8. ABS warning lamp ()

ABS warning lamp blinks when the ignition key is turned 'ON' and speedometer performing self check. This lamp goes 'OFF' once the vehicle reaches 10 km/h speed and above.

If this lamp glows continuously then have your vehicle checked at TVS Motor Company Authorised Main Dealer / Authorised Dealer (refer page No. 14 for more details).

9. Malfunction indicator lamp ()

Malfunction indicator lamp (MIL) '  ' is activated whenever the ignition is turned 'ON', till the engine is started. It will go 'OFF' once the engine is started. If this lamp glows continuously or blink* even after starting the engine, it indicates that there may be an error in the system. **Immediately contact the nearest TVS Motor Company Authorised Main Dealer or Authorised Dealer.**

10. Turn signal indicator left ()

Flashes when the left side turn signal indication is activated.

11. Digital clock

Indicates the time in 12 or 24 hour time format as per user's preferred setting. Refer page no. 48 for changing the time format between 12 hour and 24 hour.



Note

If the battery is disconnected and reconnected during service, you may need to reset the time as explained in page no. 48.

12. Fuel gauge

Digital bars indicates the approximate quantity of fuel available in the fuel tank. There are eight bars to indicate the quantity of fuel available in the fuel tank. All the eight bars will be displayed when the fuel in the tank reaches above 10.4 liters approximately (full tank).



When the fuel reaches half tank (6.5 liters approx.) the fuel gauge displays only four bars as shown.



The fuel gauge shows only single bar when the fuel reaches safe fuel level (3.5 liters approx.).



Low fuel indication (serial no. 5) starts blinking when the fuel reaches to the minimum safe level 2.5 liters approximately and no bar will be visible. Refill the fuel immediately. Once the fuel level reaches 1.8 liters approximately, no bar will be visible and low fuel indication (serial no. 5) start to glow continuously.



If all the fuel level bars in the cluster are blinking and an error message 'CHECK FUEL SENSOR' blinks at bottom, Contact nearest TVS Motor Company Authorised Main Dealer / Authorised Dealer.

⚠ Caution

Before turning the ignition key to 'ON' position, ensure the availability of adequate fuel in the tank. That is 'LOW FUEL INDICATION' shall not come 'ON', before the start of the vehicle.

To avoid dry run of fuel pump, never run vehicle beyond 5 km, after 'LOW FUEL INDICATION' is tuned 'ON'.

13. Odometer / Trip meter A & B / Lap indicator / High speed indicator / Shortest time indicator

The procedure for setting each mode is given in page no. 45.

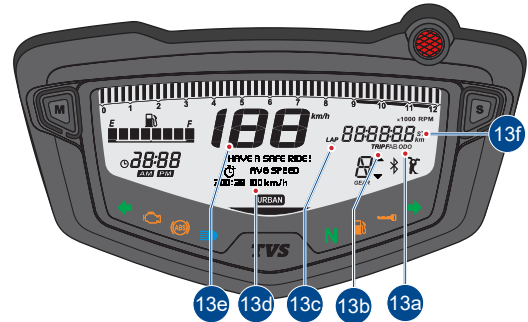

13a.Odometer

Odometer registers the total distance covered by the vehicle in kilometer. The digit after the dot mark denotes one tenth of a kilometer. Set the meter in 'ODO' mode to know the odometer reading.



13b. Trip meter

Trip meter indicates the trip distance travelled in kilometer. The digit after the dot mark denotes the one tenth of a kilometer.

Provision to measure two different distance 'TRIP A' or 'TRIP B' is provided for the users to use as per their convenience.

106.5 km
TRIP A

806 km
TRIP B

13c. Lap timer

Lap timer indicates the time taken to complete a particular lap. On entering the lap timer mode, press the 'Info switch (*i*)' on the handle bar to start a lap timer. The timer starts counting current lap's time and displays in active lap timer as shown (before starting the lap timer, ensure that the timer is reset. Refer page no. 47 for details).

LAP 00:00:15

Press the 'Info switch' again to stop the current lap timer and to start a new lap. Existing lap timings will be displayed as shown below and continue to get updated whenever a new lap is started and stopped. Long press the 'Info switch' for few seconds (more than 1 second and less than 3 seconds) to stop the lap timer count.

LAP 1:00:00:19
LAP 2:00:00:12

To start a lap timer again, after stopping it by pressing the 'Info switch', the lap timer need to be reset as explained page no. 47. You can record any number of laps but last three lap's details only will be displayed in the cluster.

Note

*Lap timer works only when the lap timer mode is active. Once the lap timer is stopped by pressing the 'Info switch', the timer cannot be started again until the timer is reset. **Only last three lap's timing will be displayed in the cluster on entering the lap timer mode.***

13d. Notification area

This is a general purpose notification area where the ride mode information, error information, service due, connectivity information, warnings are displayed.

AVG SPEED
100km/h

13e. High speed indicator

High speed indicator records the maximum speed (top speed) achieved by the rider so far in km/h. You can reset and record the new speed if required. Refer page no. 47 for resetting the high speed data. On entering the high speed mode previously achieved high speed data will be displayed in the instrument cluster as shown.

95 km/h

Whenever the vehicle speed crosses the previously achieved high speed, a message 'ACHIEVED HIGH SPEED' will be popped-up and a trophy symbol will be flashed to cheer your achievement when the vehicle speed comes less than 5 km/h.

If required, these pop-ups can be cancelled by pressing the 'Info switch (**i**)' on the handle bar else it will disappear automatically.



**ACHIEVED
HIGH SPEED**

Note

Maximum speed recorded so far will be displayed whenever the meter is set in 'HIGH SPEED' mode. This display will go off automatically once the vehicle starts moving (>5 km/h) and it will continue the normal operation.

Max speed recorded will be stored until manual reset. If the high speed is reset, the speed value will be shown as '0'.

13f. Shortest time indicator

Shortest time indicator records the minimum time taken so far to reach 60 km/h.

On entering the shortest time mode, the overall best time achieved so far will be displayed for few seconds as shown.

0 - 60 km/h : 9.25

And the last recorded time will be displayed in the shortest time recorder as given below.

9.6ST

This last recorded time can be reset as explained in page no. 47 and a new time can be recorded if required. The overall best time will be replaced automatically by the next overall best time. On achieving the new overall best time, a message 'ACHIEVED SHORTEST TIME' will be popped-up and a trophy symbol will be flashed to cheer your achievement when the vehicle speed comes less than 5 km/h.



**ACHIEVED
SHORTEST TIME**

These pop-ups can be cancelled by pressing the 'Info switch (**i**)' on the handle bar else it will disappear automatically.

Note

Overall best time achieved so far and the last recorded time to reach 60 km/h speed will be displayed when the ignition is turned 'ON' and the cluster is set in 'SHORTEST TIME MODE'.

For recording a new time, the last recorded shortest time need to be reset. On resetting time, the value will be reset to 0.0 (but the default value is 9.9 secs.). Overall best time recorded cannot be reset manually. It will be replaced automatically by next overall best time.

Once the speed reached 60 km/h, then the time will stop at the exact point.

14. Ride Modes

TVS Apache RTR 160 4V has three different ride modes, select the desired ride modes by pressing the mode switch on the right hand switch assembly (refer page no. 30).

The modes are explained in the following pages in the below sequence.

- 14a. URBAN
- 14b. SPORT
- 14c. RAIN

The preferences of mode usage are: Sport mode especially on race tracks and dry roads, Urban mode especially in city on all types of roads and Rain mode especially on wet roads.

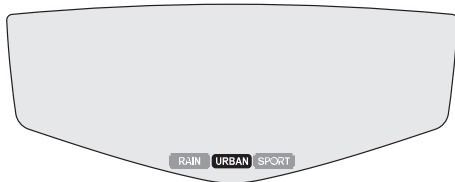

Note

At the end of self-check active ride mode information will be displayed on the LCD segment.

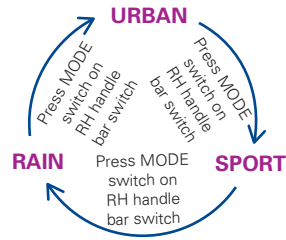

14a. URBAN mode

In 'Urban' mode the engine and ABS braking system is modified to suit city on all types of roads and riding condition. The max speed is limited to 103 Km/h and the ABS braking is optimized.

URBAN

14b. SPORT mode

In 'Sport' mode the engine and ABS braking system is modified to suit highway riding condition. The vehicle's maximum speed in sport mode is 114 km/h and the ABS braking will be aggressive with late ABS intervention however, basic safety is ensured.

SPORT

14c. RAIN mode

In 'Rain' mode the engine and ABS braking system is modified to suit wet or rainy condition. The max speed is limited to 103 Km/h and the ABS intervention is earlier and safe braking will be felt.

RAIN

Note

Mode changes are effected only when the throttle is closed after a mode change request. To guide you to do the same, a message 'CLOSE THROTTLE' will be popped-up in the notification area of the cluster.

CLOSE THROTTLE

Caution

In case any fault is detected with respect to the ride mode change in the EMS or ABS system, then your motorcycle will operate only in the 'Urban' mode after ignition key reset.

Note

If conditions for mode change are not successful 'MODE CHANGE ERROR' appears on display of the cluster.

MODE CHANGE ERROR

15. Shift RPM indicator / 16. Tachometer / 17. Trip F / 18. Gear shift indicator / 19. Service reminder / 20. Low battery indication

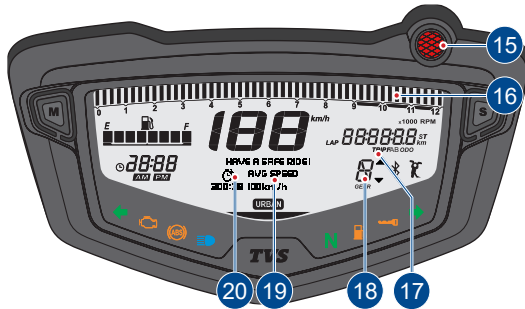

15. Shift RPM indicator

Shift RPM indicator alerts the user to up shift or down shift the gears when engine reaches the specified RPM based on the ride modes. The red indicator in the digital speedometer glows and indicates the user to shift to next higher gear or lowest gear.



UP SHIFT



DOWN SHIFT

Note

Gear shifting suggestion changes in accordance with the different operating mode of the vehicle.

Shift RPM indicator does not work when the vehicle is in neutral and upshift indication does not work when the fifth gear is engaged. Downshift indication does not work when the first gear is engaged.

16. Tachometer

Tachometer indicates the engine speed in multiples of 1000 RPM (Revolutions Per Minute).

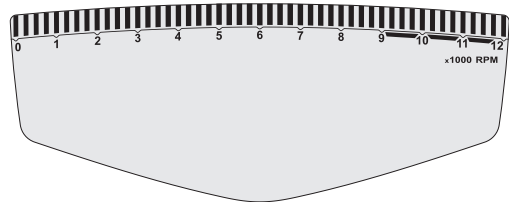

17. Trip F

'TRIP F' function shows the distance travelled after the low fuel indication symbol () starts blinking and fuel gauge shows no bar or the low fuel indication glows continuously with the fuel gauge showing no segment in the display.

At this condition, the display automatically switches to the 'TRIP F' indicator after 0.5 km and 'TRIP F' meter starts counting from 0 km.

If the fuel level continue to remain in minimum safe level, the reading is saved even after the ignition is turned 'OFF'.

The count stops and clears automatically after certain distance covered by the vehicle after the fuel level rises above minimum safe level.

'TRIP F' meter cannot be activated or deactivated manually. It will be enabled automatically until fuel level raises above minimum safe level (2.5 L).



120 km
TRIPF

18. Gear shift indicator

The gear shift indicator in the digital display indicates the position of the gears.



Note

If you notice an error message 'CHECK GEAR SENSOR', Contact nearest TVS Motor Company Authorised Main Dealer / Authorised Dealer for rectification.

19. Service reminder

If the service is due, whenever the ignition lock is turned 'ON', the following message will be popped-up after the speedometer's self diagnostic cycle and continues to pop-up till the vehicle is serviced and the reminder is reset. Get the vehicle serviced at TVS Motor Company Authorised Main Dealer / Authorised Dealer.



Note

Service reminder works only based on the distance (km) covered by the vehicle. This is only a reminder indicator. Customers are advised to keep track and follow the service schedule.

20. Low battery indicator

The following message will be popped-up after the speedometer's self diagnostic cycle when the battery charge is too low. Get the battery checked at TVS Motor Company Authorised Main Dealer / Authorised Dealer.

LOW BATTERY

Note

Service reminder and battery low indicator pop-ups can be cancelled by pressing the 'Info switch (*i*)' on the handle bar.

MODE AND SET BUTTONS

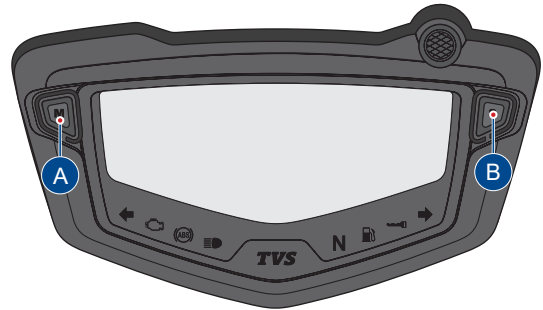

The Mode (A) and Set (B) buttons are provided to change between various modes and to set the some of the digital display functions of the instrument cluster. The sequence of modes and their selections are explained in detail below.

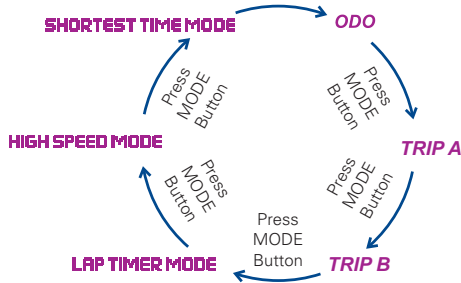

Short press the Mode button to access the following modes:

1. ODO
2. TRIP A
3. TRIP B
4. LAPTIMER
5. HIGH SPEED INDICATOR
6. SHORTEST TIME INDICATOR

Note

Above mode changes are possible only when the vehicle is in static condition for safety.

Trip F comes-in after Trip B once enabled.

On long pressing the Mode button, the following modes can be accessed.

1. CLOCK SETTING MODE
2. BLUETOOTH PAIRING MODE
3. ILLUMINATION MODE

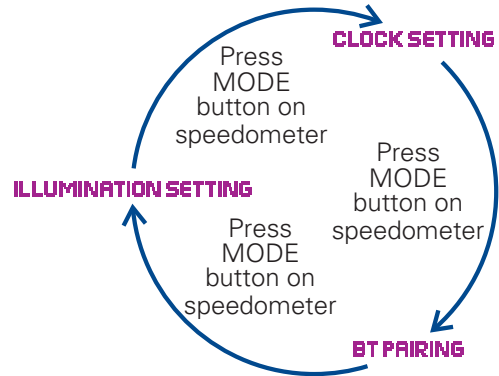

Setting the digital display

Every press of the Mode button changes the display to other mode. Follow the below procedures to change the display to desired mode.

If the ignition is turned 'OFF' while the cluster is in 'ODO' or 'TRIP' mode, then the respective meter will be displayed during next ignition 'ON'. If any other modes other than the above were set while turning the ignition 'OFF', then 'ODO' meter will be displayed by default during next ignition 'ON'.

1. In 'ODO' mode, press the Mode button once or twice to enter '**TRIP A**' and '**TRIP B**' meter respectively.
 - To reset any of the trip meter, while ensuring the display is in 'TRIP A' or 'TRIP B', press and hold the Set button for a few seconds.
2. In 'TRIP B' meter mode, press the Mode button once to enter lap timer mode. On entering the lap timer mode, a message '**LAP TIMER MODE**' and last three laps timing will be displayed in the cluster's display.
 - To reset the lap timer, keep the display in 'LAP TIMER MODE' and wait till the cluster displays the lap timings. Now press and hold the Set button for a few seconds.
3. In 'TRIP B' meter mode, press the Mode button twice to enter high speed mode. On entering this mode, a message '**HIGH SPEED MODE**' and last achieved high speed data will be displayed in the cluster's display.
 - To reset the high speed recorded, keep the display in 'HIGH SPEED MODE', press and hold the Set button for few a seconds.
4. In 'TRIP B' meter mode, press the Mode button thrice to enter shortest time mode. On entering this mode, last achieved shortest time '**95^{sr}**' and overall best time '**0-60 km/h: 9.25**' will be displayed in the cluster's display.
 - To reset the last achieved shortest time, keep the display in 'SHORTEST TIME MODE', press and hold the Set button for few a seconds. Please remember only last / current record will be reset and best time display will remain same until new best time is achieved.
5. Press the Mode button once to change the display to 'ODO' mode again.

Digital clock setting

1. Ensure the display is in 'ODO' mode.
2. Press and hold the Mode button for few seconds till the display enters clock setting mode '**CLOCK SETTING**'.
3. On pressing the Set button, if the clock is in 12 hours format, the hour format 'AM' or 'PM' blinks. Else the clock will be ready for 24 hours format selection.
4. Press the Mode button to change the hour format 'AM' or 'PM' or to change the clock to 24 hours format.
5. If the clock is in 24 hours format press the Mode button once again to set the clock to 12 hours format.
6. Press the Set button again so that the hours digit of the clock blinks.
7. Now, press the Mode button to increase the hours while hour digits are blinking.
8. On pressing the Set button again the hours of the clock is set and the minute digit blinks.
9. Now, press the Mode button to increase the minutes while minute digits are blinking.
10. Press the Set button again to set minutes and to come out from clock setting.

Note

If the display is set to MPH mode, it will switch to Km/h.

Bluetooth pairing mode ' * '

Using the Bluetooth pairing mode the connected instrument cluster of 'TVS Apache RTR 160 4V' can be connected to your Android™ smart phones and iPhone® via Bluetooth® through a TVS CONNECT app which can be download from Google Play and the Apple store®.



TVS CONNECT

Note

If the Set button is pressed when the instrument cluster is in normal operating mode like 'ODO', 'TRIP' etc. following information will be popping out which is not applicable to present model.

NEXT SERVICE

Note

Maximum of Android phones can be auto-paired with the instrument cluster.

Only can be auto-paired with a single instrument cluster at a time. If the user need to connect multiple iPhones with the single instrument cluster, the previous connected iPhone has to be forgotten by clicking, 'Forget This Device' from Bluetooth settings in the iPhone.

If the vehicle battery is reset or fuse is blown, then too 'Forget This Device' from Bluetooth settings in the iPhone has to be done.

Steps to “Forget This Device” in iPhone:

If the user needs to connect multiple iPhones with the single instrument cluster, the previous iPhone has to be forgotten using ‘Forget This Device’ from Bluetooth settings in the following manner:

1. In the previous connected iPhone, open the SETTINGS -> BLUETOOTH.
2. Select the instrument cluster, which was connected previously.
3. Click on the ‘Forget this device’.

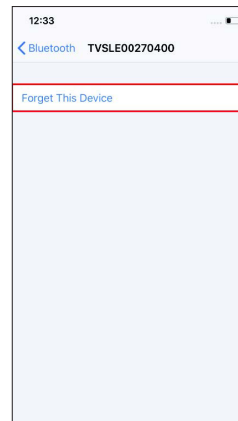
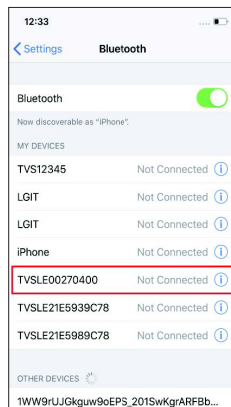

First time Bluetooth pairing:

To pair your Android smart phone or iPhone with your TVS Apache RTR 160 4V motorcycle's connected instrument cluster, via Bluetooth, for the first time, follow the procedure as described below:

1. Ensure the display of the instrument cluster is in 'ODO' mode.
2. Press and hold the Mode button for few seconds till the display enters clock setting mode '**CLOCK SETTING**'.
3. Release and press the Mode button once so that the display enters '**BT PAIRING**'.
4. Now, press the Set button to establish the connection with your smart phone.
5. On pressing the Set button the connected instrument cluster checks for the near by available smart phone and displays the TVSM device name.
6. Now, press the 'Connect icon' of the mobile app to establish the connection with the cluster.

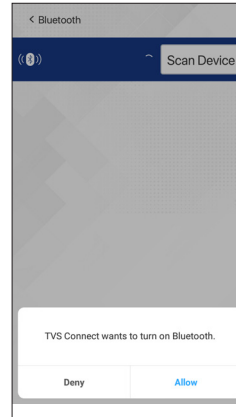

On pressing this icon, the app opens a screen where you will be asked to grant permission to turn 'ON' your smart phone's Bluetooth if it is in 'OFF' condition. Turn 'ON' the Bluetooth. Else, press the 'Scan Device' icon to initiate the search incase the app is not searching automatically. The app searches and lists the available clusters. Just select the listed cluster. The app communicates with the cluster and the cluster generates a pass key.

Enter this pass key in the app screen to complete the connection.

PASS KEY 127542

Note

For the first time pairing, the connected instrument cluster should be in 'BLUETOOTH PAIRING MODE'.

During the course of pairing process, there is any occurrence of error, the connected instrument cluster should be turned 'OFF' and 'ON', and the application also need to be restarted.

Please remember that, all the smart phones are not compatible for pairing with the TVS Apache RTR 160 4V motorcycle's connected instrument cluster.

During the search of Bluetooth devices in app, if the vehicle's connected instrument cluster Bluetooth device ID is not visible, try for one or two more iterations.

If the phone enters battery saver mode, auto-pairing might not happen. It takes maximum of five minutes for auto-pairing and it can happen in vehicle running below 10 km/h speed or engine at idling or engine off condition.

If the pass key entered wrongly then the instrument cluster displays the following message.

PASS KEY WRONG

On connecting with the smart phone successfully, the instrument cluster displays the user name which is fetched from the smart phone as shown.

CONNECTED TO SUNIL

Note

Auto-pairing happens only if the application is locked in the RAM in multitasking screen of the phone with manufacturer's customised OS (Ex. : MI, Vivo etc.).

In case of Android phones with Android OS version above 8.0 for App to work seamlessly, any battery optimisation setting to be removed in the TVS Connect app and GPS shall be allowed to run in background in high accuracy mode.

Even if your phone's Bluetooth is already paired to other gadgets like smart watch, health band or helmet, the auto-pairing works with your TVS Apache RTR 160 4V motorcycle's connected instrument cluster.

Note

In Android and IOS smart phones, if the Bluetooth is 'ON', and if the app is already paired with the cluster, when the user opens the app with the ignition turned 'ON', the app connects automatically with the cluster once the user takes his phone to near by the vehicle (if the auto connect setting of your smart phone is turned 'ON'). This feature can be disabled if required. Auto connect will only work with the last paired mobile phone.

If the application unfortunately stops due to unfrozen circumstances. Close and reopen the application and do the manual pairing for the first time, then auto-pairing will happen subsequently.

For first time pairing, logout from the app, login again with your login credential and press 'Connect' icon.

Customer window

This is the default window when the connected instrument cluster of your TVS Apache RTR 160 4V is connected with your smart phone using Bluetooth '❄':

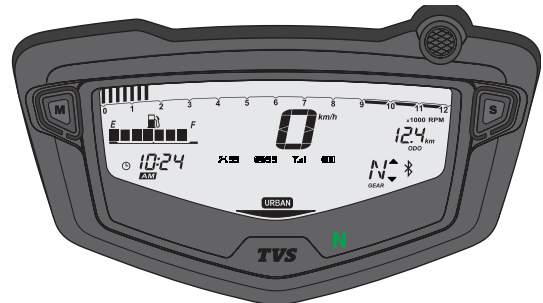

Once the cluster is connected with the smart phone, the cluster displays the signal strength of the network provider '📶' and the battery level '🔋' of the smart phone. Number of unread messages '📧' and number of missed calls '📞'.

 **Note**

Incase multiple SIM cards are used in smart phone, by default, SIM 1's network provider's signal strength is shown in the display of connected instrument cluster.

Signal strength displayed in connected instrument cluster might vary from the display in smart phone as the former is referred from telephonic standards.

Incoming call alert display (📞➤)

The connected instrument cluster will display the incoming calls alerts from the smart phone via Bluetooth. Ex. 'AKASH', will be displayed if the contact is stored in the smart phone otherwise number will be displayed. Ex. '9897712345' (**in IOS only "Incoming call" will be displayed**).

📞➤ SUNIL

📞➤ +919897712345

Missed call alert display 'X01'

The connected instrument cluster displays the total number of missed calls from the smart phone via Bluetooth.

5 MISSED CALLS**SMS alert display '📧01'**

The connected instrument cluster displays the incoming SMS from the smart phone via Bluetooth and the SMS count will be updated on the instrument cluster.

 **Note**

Incoming calls, missed calls and SMS alerts can be cancelled by pressing the 'Info switch ()' on the handle bar (in IOS, pressing the switch only clears the notification but the call will not be cancelled in the phone).

Navigation window

Once the navigation assist is turned 'ON', the display of your TVS Apache RTR 160 4V motorcycle's connected instrument cluster enters into navigation window and displays the turn by turn navigation instruction with a simple and elegant graphical representation.

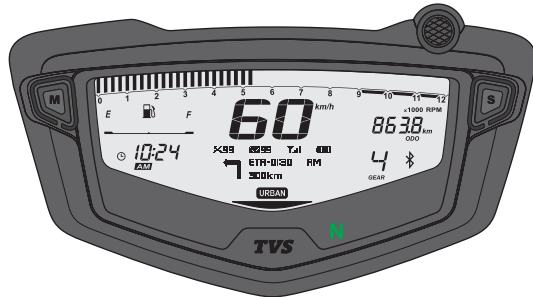

Note

Please remember that the Navigation License has to be renewed after 5 years of vehicle purchase and renewal can be done by contacting nearest Dealer.

Low fuel alert

When the fuel level in the vehicle reaches below reserve level, the app sends a low fuel alert to the connected instrument cluster to give notification of the fuel level. The same alert will be also shown in the app.

Low fuel assist \ Nearest location alert

When the fuel level is low, the app sends a fuel assist message to the instrument cluster. You can either accept or reject the assist request.

If you accept the request (by pressing the 'Info switch' on handle bar about 3 secs.) the app will automatically provide navigation to the nearest fuel pump.

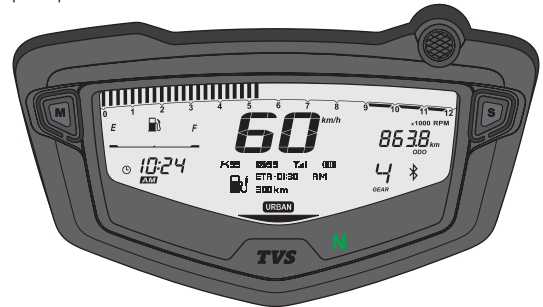

The customer also can choose to reject the request (by pressing the 'Info switch' on the handle bar for about 1 sec.). In that case, the previous display will remain in the cluster.

Clock auto sync

Whenever the app is connected to the connected instrument cluster the clock of instrument cluster gets synchronised with the clock of the phone.

G-force measurement

G-force measurement provides an approximate G-force measure wherein the vehicle is operated. The G-force will be measured during both acceleration and deceleration of the vehicle.

Note

The G-force is measured based only on the vehicle speed and not with an on-board measurement unit. So there might be a variation between the actual and the measured values. The G-force value displayed is only an estimate of the actual value.



Caution

The value of G-Force is indicated in the mobile application to understand the braking force applied or driving behavior of rider. We recommend the customer to drive safe and keep sufficient distance with respect to vehicle at front and also recommend to drive within the recommended safe limit of driving.

TVS CONNECT APP*



Dedicated smart phone app is available in the Google Play and the Apple store for your TVS Apache RTR 160 4V and it can be installed in your Android smart phones and iPhones. To access the features of your TVS Apache RTR 160 4V's connected instrument cluster like:

1. Incoming call alerts in connected instrument cluster.
2. Incoming SMS alerts in connected instrument cluster (applicable only for Android smart phones).
3. Number of missed call alerts in connected instrument cluster.
4. Battery status of your smart phone in connected instrument cluster.
5. To send auto reply SMS to the callers via smart phone (applicable only for Android smart phones).
6. 'Do Not Disturb' mode during the ride (applicable only for Android smart phones).
7. To send navigational assist instructions inputs to the connected instrument cluster from your smart phone.
8. To save the last traveled route.

9. To locate the last parked location of your TVS Apache RTR 160 4V.
10. To know the signal strength of your mobile network in connected instrument cluster.
11. To generate and store Ride reports.
12. To sync the connected instrument cluster clock with smart phone clock.
13. To access voice assist and voice feedback functionality during connected rides.
14. To receive personalized messages and vehicle alerts during connected rides.

This dedicated mobile app of your TVS Apache RTR 160 4V can be downloaded from the Google Play and the Apple store by searching the key word 'TVS CONNECT' else by scanning the below QR code.



Android



iOS

Note

This smart phone app is compatible only for the smart phones with Android OS version 8.0 and above, iOS version 11 and above and the BLUETOOTH version 4.0 and above. **Android and Google Play are trademarks of Google LLC. App Store® and iOS are trademark of Apple. The smart phone app is updated time to time to capture upgrades to the mobile operating system. Though these updates are tested on the majority of the mobile phones in the market before release, it may lead to disablement of few functions on some of the operating system.**

Warning

TVS Motor Company Limited does not recommend usage of any type of Mobile Hand Held Devices, and applications / features whether installed or associated with the vehicle which deprives the rider's attention and focus while riding the Two Wheeler. The customers and riders are strictly advised to understand the applicable laws, road safety Rules and the local laws on usage of electronic devices while operating the vehicle. Usage of any Mobile or hand held devices, and / or applications / features while riding the vehicle is totally at customer's / rider's risk. The product and features have technical limitations and are for general overview only.

How to login

On opening the **TVS CONNECT** app the following introductory screens will be displayed.

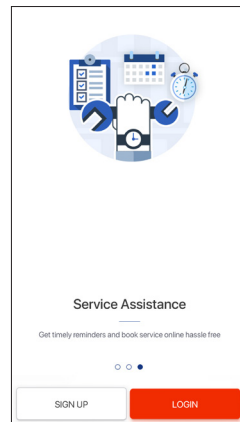

Move to the last screen where you will find the 'SIGN UP' and 'LOGIN' tab. If you are having login already then press login tab. A screen with various login options opens-up as shown.

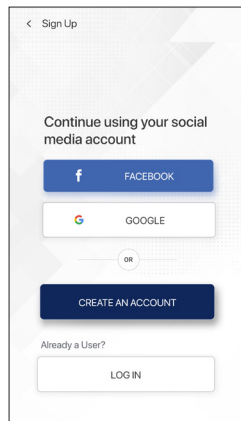
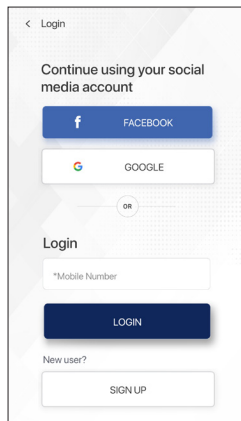

You can login using your social media logins like FACEBOOK and GOOGLE or using your mobile number which has been registered already.

If you are a new user then press the sign up tab where you will find various options for registering using your social media logins like FACEBOOK and GOOGLE or a tab for creating new account.

Using your social media logins you can create new login else press the 'CREATE AN ACCOUNT' tab.

On pressing the 'CREATE AN ACCOUNT' tab, a screen opens with various input details. Feed in your details and submit. On submitting the details a screen opens with one time password (OTP) entry.

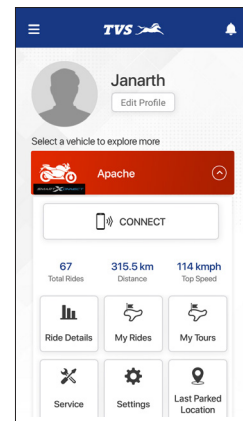
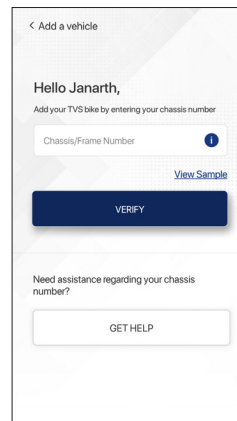

Enter the OTP which is received from TVS Motor Company Limited and submit. On submitting the OTP, another screen opens where you have to enter your vehicle's chassis number for verification.

< Sign Up

Fill in your details

*Full Name

*Mobile Number

*Email ID

*City

*mandatory fields

I accept [Terms & Conditions](#)

SUBMIT

< Verify OTP

An OTP has been sent to your mobile number

Enter OTP

SUBMIT

[RESEND OTP](#)

Waiting for OTP: 23

After successful verification of your chassis number, the Home screen of the app opens.

Note

Please remember that the navigation License has to be renewed after 5 years of vehicle purchase and renewal can be done by contacting nearest Dealer.

Add vehicle

Add vehicle tab allows you to add any of your TVS bikes by entering its chassis number. You can have sample view of the frame number and also you can get help by chatting with us or by E-mailing to us or by calling us.

< Add a vehicle

Hello Janarth,

Add your TVS bike by entering your chassis number

Chassis/Frame Number

[View Sample](#)

VERIFY

Need assistance regarding your chassis number?

GET HELP

< Get Help

Need assistance with updating your phone details? Get in touch

Chassis No*:

Name*:

Upload RC copy*: Upload

Maximum size of 5 mb allowed

Upload Driving License*: Upload

Maximum size of 5 mb allowed

Number to be updated*: Mobile

Comments:

Add your comments

Voice assist

The connected functionality has come with an additional feature - Voice assistant. With help of the voice assist feature, the rider will be able to access mobile application and instrument cluster through speech. Once the mobile application is connected to the instrument cluster, voice assist feature can be used

There are two ways to invoke voice assist in your vehicle:

1. By long press of the info switch, when the notification area is displaying customer window.
2. By pressing the voice assist icon in the app live dashboard or in other mobile application screens.

After invoking voice assist through either of the two ways, "Listening" will appear on the screen and a "speak now" will be heard on the headset.

Wait for a second and start speaking/providing the command, once you hear "Speak now".

The following are the list of intents recognized by

Note

Voice assist will work with screen lock condition / app background condition (depending upon smart phone's OS restrictions). Use Wired / Wireless earphones for listening and talking. Voice feedback will work only if a wired / wireless headphone is connected. Option to enable/disable voice assistant and voice feedback is available in App settings.

voice assist. You can refer page no. 62 for sample commands of each intent:

- Greeting command
- Navigation command
- Reset trip meters
- Nearest POI command
- Current location
- Last call
- Enable / Disable High Speed Alert
- Ride start time
- Volume increase / decrease
- Brightness increase / decrease

Voice assist commands and key words

S. No.	Intent	Commands	Voice Feedback
1	GREETING	Hi buddie	Hello '____'
		How are you doing	
		Hi buddie	
		Hey buddie	
		Hello friend	
		How u doing	
2	NAVIGATION	Go to	Taking you to '____'
		Take me to	
		Let's go to	
		Navigate to	
		Navigate me to	
		Guide me to	
		Show me	
		Take to	
		Directions to	
		Show me Directions to	

S. No.	Intent	Commands	Voice Feedback
3	RESET TRIP A MODE	Reset TRIP A	Trip A Mode Reset Complete
		Reset TRIP A Data	
		Reset Trip A Info	
		Erase Trip A	
		Clear Trip A	
		Clear Trip A Data	
4	RESET TRIP B MODE	Reset TRIP B	Trip B Mode Reset Complete
		Reset TRIP B Data	
		Reset Trip B Info	
		Erase Trip B	
		Clear Trip B	
		Clear Trip B Data	
5	POI	Near	Taking you to nearest '____'
		Near by	
		Near to	
		Nearest	

S. No.	Intent	Commands	Voice Feedback
6	CURRENT LOCATION	My location	You are around ' ____ '
		What is the name of this place	
		Where am i now	
		What is my current location	
		Show my location	
		Show my current location	
		Show current location	
		Show location	
		Where are we right now	
7	CALL LAST	Last call	You have last call from ' ____ '
		Who called me last	
		Who called recently	
		Last caller	
		Show my last caller	
		Who is my last caller	

S. No.	Intent	Commands	Voice Feedback
8	RIDE START TIME	When did I start my ride	Ride Time '____'
		What time I start ride	
		When did we start from home / work	
		Ride start time	
		Show start time	
		Show ride start time	
9	VOLUME INCREASE	Increase volume	Volume Increased
		Volume up	
		Increase sound	
10	VOLUME DECREASE	Decrease volume	Volume Decreased
		Volume down	
		Decrease sound	
		Reduce volume	
11	SETTING HIGH SPEED ALERT ENABLE	Enable high speed alert	High speed alert setting enabled
12	SETTING HIGH SPEED ALERT DISABLE	Disable high speed alert	High speed alert setting disabled

S. No.	Intent	Commands	Voice Feedback
13	END NAVIGATION	Cancel navigation	Navigation ended
		End navigation	
		Exit navigation	
		Stop navigation	
14	BRIGHTNESS INCREASE	Brightness Increase	Brightness increased / Maximum brightness
		Brightness up	
		Brightness high	
		Increase brightness	
		Increase the speedo brightness	
		Increase the brightness	
		Turn up the brightness	
Increase the brightness			
15	BRIGHTNESS DECREASE	Brightness decreased	Brightness decreased / Minimum brightness
		Brightness down	
		Brightness low	
		Decrease brightness	
		Decrease the speedo brightness	
		Turn down the brightness	
		Decrease the brightness	

 **Note**

The list of commands and intent will be updated periodically. Please refer to the command list mentioned in the mobile application to stay updated.

Things to do while using voice assistant:

1. We recommend to use ANC (Active Noise Canceling) Bluetooth devices for better performance
2. Ensure Microphone is kept near to your mouth while giving out commands
3. Please ensure that it is not exposed to outside environmental noise such as wind noise, other vehicles' noise etc.
4. We recommend you to go through the sample command list before trying your intent.
5. Kindly refer to the voice feedback of the detected place name when you provide voice command for navigation.
6. Make sure you have the information tray of cluster displaying customer window when voice assist is invoked through vehicle switch.
7. Ensure your safety while using voice assist functionality

Things not to do while using voice assistant:

1. We recommend you not to use the method of invoking voice assist through mobile App while riding.
2. Please do not use voice assist functionality during heavy traffic condition.

Voice feedback

Apache RTR 160 4V also has feature of voice feedbacks along with voice assist functionality.

Voice feedback feature communicates from vehicle to customer of either critical parameters like fuel level or rider warnings like direction indicators and side stand alert chimes. Some of the features in voice feedback like Turn on Mobile data, GPS signal low will work only in Voice assist mode as shown below:

Sl. No.	Feature	Voice feedback	Display in cluster
1	If the signal strength is poor	Poor network	POOR NETWORK
2	If the GPS signal is poor	Low GPS signal	GPS SIGNAL LOW
3	Fuel low warning	Check fuel low	WARNING FUEL LOW
4	If mobile data is required for a particular feature but if mobile data is not ON	Turn on mobile data	TURN ON MOBILE DATA
5	If Location access is not provided	Need GPS permission	NEED GPS PERMISSION
6	If location access is required for a particular function but if GPS is OFF	Turn on GPS	TURN ON GPS
7	If ride is not started	Please start ride	PLEASE START RIDE
8	If phone battery is low	Phone battery low, Please connect to vehicle mobile charger	PHONE BATTERY LOW



Sl. No.	Feature	Voice feedback	Display in cluster
9	If side stand is in stand down condition	Alert chime	-No change-
10	If direction indicators is turned ON	Alert chime	-No change-
11	If the engine temperature is greater than threshold value	Take a Break, your bike is running hot	HIGH ENGINE TEMP
12	If the connected ride is for longer duration	Break Time	BREAK TIME
13	If the brightness of the cluster is maximum and increase brightness command is given	Maximum brightness	BRIGHTNESS XX%
14	If the brightness of the cluster is minimum and decrease brightness command is given	Minimum brightness	BRIGHTNESS XX%
15	If the volume of the mobile phone is maximum and increase volume command is given	Maximum volume	MAXIMUM VOLUME
16	If the volume of the mobile phone is minimum and decrease volume command is given	Minimum volume	MINIMUM VOLUME

RAM AIR DUCT

TVS Apache RTR 160 4V is designed with a ram air duct on the right side of the fuel tank. This ram air duct throws air exactly above the spark plug while the vehicle is in move.

The air thrown above the spark plug cools the plug and maintains its temperature in optimum level. Which in-turn results in better heat management without any compromise on the engine performance and improves the engine's durability.



Caution

Care should be taken not to block the ram air duct and air passage by cover or any other means. Else it will lead to over heating of engine or seizure.

DAYTIME RUNNING LAMP (DRL)

TVS Apache RTR 160 4V comes with a day time running LED lamp which glows when the headlamp switch is 'OFF'.

After switching 'ON' the head lamp, the DRL continue to glow with reduced intensity of illumination (becomes Front Position Lamps) along with low beam. Refer page no. 29 for the control switch position details.



LED HEAD LAMP

TVS Apache RTR 160 4V comes with a LED head lamp which glows in 'low beam' after switching 'ON' the head lamp switch even if the engine is in 'OFF' condition and 'high beam' glows based on the beam control switch position and engine running condition. The head lamp beam (high/low) can be controlled by pressing the beam control switch refer page no. 28.



FUEL TANK# CAP

Flush type fuel tank cap (1) is provided in TVS Apache RTR 160 4V. To open the fuel tank cap, lift the protection lid (2) and insert the control key into the lock. Turn the key in clockwise and lift the cap. Press the cap back to close. Rotate the key in anti-clockwise direction and take out. Close the lid.

To avoid accumulation of water in the fuel tank, a small drain hole and a pipe is provided in the fuel tank lid cavity so that the water entering through the lid is drained out through the hose.



The fuel tank is not a measuring instrument and the capacity of the fuel tank may slightly vary from the indicated capacity.

Warning

Do not smoke while refueling. Do not use cell phones while refueling. Avoid spilling of fuel on the hot engine. Refill petrol in well ventilated area.

Switch off the engine while refueling as petrol is highly inflammable. After refilling close the cap properly.

EVAPORATIVE EMISSION CONTROL SYSTEM

This vehicle is fitted with Evaporative Emission Control System (EVAP).

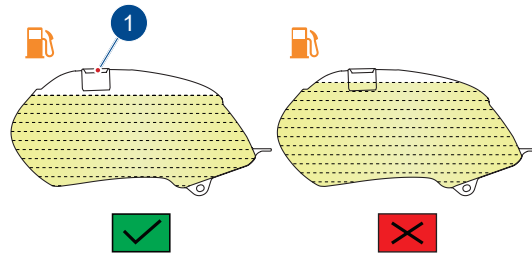

If there is any abnormal jerk, startability issue are felt in the vehicle or noise due to sudden escape of gas during opening of fuel tank cap, immediately report to the TVS Motor Company Authorised Main Dealer / Authorised Dealer.

Caution

Never fill fuel beyond the fuel tank inlet (1). Filling above the inlet may result in improper breathing of fuel tank which leads to difficulty in starting as well as improper running of the vehicle.

Whenever refueling the bike fill only the recommended quantity of fuel (10 liter including reserve).

Do not clean the vehicle by laying down on floor, to avoid fuel entry into EVAP system.

STANDS

TVS Apache RTR 160 4V is equipped with a centre (1) and side stand (2).

To place the vehicle on the centre stand, hold the handle bar left grip with left hand and pillion handle with right hand. Place your foot firmly on the centre stand extension (1a) and press with adequate effort. Ensure both the legs of centre stand are touching the ground before placing the vehicle on the stand.

Side stand can be operated by sitting on the vehicle with your left foot by pushing it away from the vehicle to its extreme end.

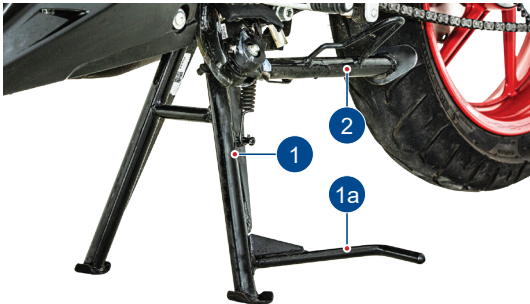

Warning

Park the motorcycle safely on a solid ground. On slopes, engage the first gear and park the vehicle in such a way that the front wheel faces uphill.

Always retract the side stand to its full up position before moving the vehicle. Else, the vehicle will get 'Switched OFF'.

Caution

Do not sit on the vehicle when it is parked on the side stand / centre stand, as your full weight would rest on the vehicle's only support.

SEAT ASSEMBLY

The seat lock (1) is located at the rear end of the vehicle below the tail lamp assembly.

Seat removal

To remove the seat assembly, insert the ignition key into the seat lock and turn it in clockwise direction. Take out the seat assembly by lifting it from the rear end and gently tapping it on the front end.



Caution

Make sure that the seat assembly is locked securely in position after reassembly.

Seat re-assembly

Locate the seat assembly into the frame. Push it little foreword and press at rear end till you hear the 'click' sound.

TOOL KIT AND FIRST AID KIT

To assist you in performing certain aspects of periodic maintenance and emergency repairs, a tool kit is supplied along with the vehicle. A first aid kit is also available along with the tool kit.

Both tool kit and first aid kit are located under the seat. To access the tool kit / first aid kit, remove the seat assembly as explained in page no. 75.

Tool kit consists of one number each of the following.

1. Grip driver
2. Bit (+) (-)
3. 12 x 14 open end spanner
4. Tool bag



Warning

Do not remove the tool kit and first aid kit from the vehicle. Always ensure to keep them along with the vehicle. Ensure the first aid equipments are changed periodically based on the date of expiry.

Caution

It is recommended to use the tool kit in case of any emergency only. It is always advisable to take your vehicle to TVS Motor Company Authorised Main Dealer / Authorised Dealer.

COVER FRAME R



Removal

Cover frame R is to be removed to access the battery and rear disc brake master cylinder. Follow the procedure to open the cover frame:

1. Remove the seat assembly as explained in page no. 75.
2. Remove the mounting screws fixed at the locations (1), (2) and (3).
3. Gently dislocate and take out the cover frame from the vehicle.

Re-install

1. Locate the lugs of the cover frame at the holes provided on the frame carefully while ensuring the availability of cushions.
2. Install and tighten the mounting screws (1), (2) and (3).
3. Reassemble the seat assembly.



Caution

Make sure that the cover frame is locked securely in position after installation.

ADJUSTMENTS

CLUTCH LEVER - ADJUSTMENT*

TVS Apache RTR 160 4V comes with an adjustable clutch lever. There are three positions provided for you to adjust the lever to suit your palm size. The lever can be adjusted by adjusting the position adjuster (A) provided in the knob itself. 'Position-1' is the closest position of the lever to the handle bar grip and 'Position-3' is the farthest.

To adjust the lever position, push the lever forward and rotate the position adjuster to any of the three positions by aligning the 'arrow mark' on the lever to the position number provided on the adjuster.

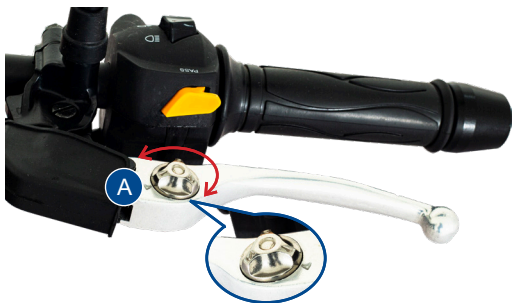

FRONT BRAKE LEVER - ADJUSTMENT*

TVS Apache RTR 160 4V comes with an adjustable front brake lever. There are three positions provided for you to adjust the lever to suit your palm size. The lever can be adjusted by adjusting the position adjuster (B) provided in the knob itself. 'Position-1' is the closest of the lever to the handle bar grip and 'Position-3' is the farthest.

To adjust the lever position, push the lever forward and rotate the position adjuster to any of the three positions by aligning the 'arrow mark' on the lever to the position number provided on the adjuster.

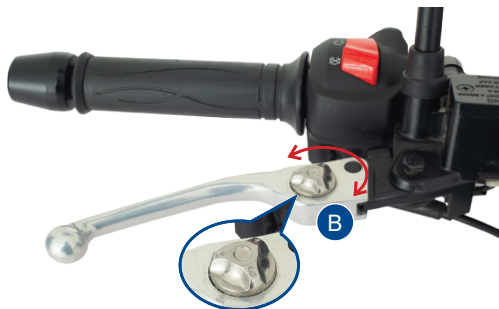

* Adjustable lever is applicable for select variants only

**Caution**

Do not try doing any adjustment while riding as it may lead to fatal accident.

Do not use any tool or objects to turn the position adjuster. Do it by hand only.

**Note**

While adjusting the lever position, ensure the proper aligning of position adjuster number with the arrow mark on the lever.

Check and ensure the proper free play of both clutch and front brake after adjusting the lever position.

PRE RIDE INSPECTION

Check the following items before riding

ITEM	WHAT TO CHECK FOR
Engine cum transmission oil	Availability of oil upto the level (page no. 97)
Fuel	Enough fuel for the planned distance of running
Tyres	Correct pressure (page no. 103) Adequate tread depth / No cracks or cuts.
Battery	Proper working of all lamps, horn and pass by switch. Low battery indication Battery charge (page no. 92)
Digital instrument cluster	Performing self check / Proper working of warning lamps (page no. 34)
Malfunction indicator	Turned 'OFF' after starting the engine (page no. 36)
Steering	Smooth movement / No play or looseness
Throttle	Correct free play of cable / Smooth operation
Clutch	Correct free play of cable (page no. 98) / Smooth and progressive action
Brakes	Availability of brake fluid and proper working of brakes (page no. 101)
Wheels	Free rotation
Drive chain	Slackness and lubrication of chain (page no. 107)

Caution

Do not switch 'ON' the ignition without minimum level fuel in tank. It will cause damage to the fuel pump.

STARTING THE ENGINE

As you turn the ignition switch to the 'ON' position, the instrument cluster and the warning lights will go through the self-diagnostic cycle. During this phase, make sure that all the warning lights on the cluster comes on.

The following conditions must be verified before starting the engine.

- ❑ The engine cut off switch is in 'O' position.
- ❑ Side stand is in retracted condition.
- ❑ The gear is in neutral.
- ❑ If gears are engaged, the clutch lever must be pulled.

Press the start button without applying the throttle. As soon as the engine starts, release the start button. The engine will not start if the throttle is opened full.



Caution

Do not keep the engine in idling rpm for long.

Do not open excessive throttle when the vehicle is parked. It leads to overheating of engine and damage to the internal components.

SETTING THE VEHICLE IN MOTION

1. Press the clutch lever and engage first gear by pressing the gearshift lever down.
2. Open the throttle slowly and simultaneously release the clutch lever gently & gradually. The vehicle starts moving forward.
3. As the vehicle picks up speed, shift to the next higher gear by closing the throttle, applying the clutch and lifting the gear shift lever up.
4. Release the clutch lever and open the throttle smoothly. Select the required gears in a similar manner.

Using the transmission

The transmission is provided to keep the engine to run smoothly in its normal operating speed range.

The gear ratios have been carefully chosen to meet the characteristics of the engine. The rider should always select the most suitable gear to achieve the necessary speed and pulling power smoothly.

Riding on hills/gradients

When climbing steep hills, the motorcycle may begin to slow down and show lack of power. At this point, the rider should shift to a lower gear so that the engine will again be operating in its normal power range. Shift gears rapidly to prevent the motorcycle from losing momentum.

When riding down a hill, the engine may be used as brake by shifting to a lower gear.

STOPPING AND PARKING

1. Close the throttle completely and apply both the brakes simultaneously.
2. Down shift the gears with clutch lever pressed / disengaged as the road speed decreases. Bring the engine to neutral position just before the vehicle stops.
3. Turn the ignition 'OFF'.
4. Park the vehicle on a firm, flat surface.
5. Lock the steering.

Warning

Reduce speed to a safe limit before turning/cornering. Do not apply brake while turning/cornering. Do not disengage clutch before braking.

Warning

Since the engine and exhaust system becomes very hot, make sure to park the vehicle in a place where pedestrians or children are not likely to touch the hot surface. Do not park near dry grass or any other flammable resources which might catch fire.

To avoid deterioration of paint gloss due to ultra violet rays and heat of sunlight, always park your motorcycle in a covered parking.

FUEL RECOMMENDATION

Use only BS VI petrol with minimum RON 91.

BS VI petrol containing upto 20% of ethanol by volume can be used.

Higher ethanol content in petrol can lead to

- degrade plastic and rubber components of fuel system and vehicle parts
- cause corrosion damage to metal parts like fuel tank, etc
- result in startability & drivability issues
- decrease fuel economy

Ethanol absorbs water very easily, resulting fuel separation. Extra care shall be taken to prevent moisture entry into fuel tank while filling ethanol blended petrol and water washing of vehicle. Painted parts (viz. panels, covers) shall not come in contact with ethanol blended fuels.

Manufacturer is not responsible for any warranty issues that results from using ethanol blend in excess of 20% by volume.

In case of any abnormalities observed due to use of ethanol blended fuels, customers are advised to use a different fuel station / brand for standard E20 fuel or contact authorised service centres.



Caution

Never mix oil and petrol in the fuel tank. Always fill fuel from reputed and reliable fuel stations.

CHECKS AND TIPS FOR IMPROVING FUEL ECONOMY

Regular checks

Carry out the periodic maintenance checks as specified in this manual (refer page no. 87).

Regular maintenance checks will save fuel ensuring trouble-free, enjoyable and safe riding besides keeping the environment clean.

Spark plug

A dirty or defective spark plug leads to wastage of fuel due to incomplete combustion. Inspect and clean the spark plug if necessary. Visually inspect the spark plug gap. If the gap is found more replace the plug with a new one.

However the spark plug need to be replaced every 12000 kms or 1 year whichever is earlier. Always use recommended spark plug only.

Air cleaner element

A dirty air cleaner element restricts airflow and increases fuel consumption. **Replace the element every 12000 kms.**

Since paper filter is used in your motorcycle, it is not advised to clean the filter. Replace the filter in case of any abnormalities.

 **Caution**

Do not remove the spark plug when the engine is hot.

Please ensure that the ram air duct is not getting damaged during removal / reassembly of spark plug.

Clutch

Increase in engine speed during acceleration and constant speed running, without increase in vehicle speed indicates clutch slip. The clutch slip will cause high fuel consumption, poor acceleration and overheating of engine.

If the condition persists even after adjusting the clutch lever play, immediately have the clutch checked by TVS Motor Company Authorised Main Dealer / Authorised Dealer.

Engine cum transmission oil

Dirty or less engine cum transmission oil increases the friction between various parts of the engine and reduces the engine life, thereby increases fuel consumption.

Regularly inspect the engine cum transmission oil for correct level and top-up if necessary. Get it replaced at regular intervals as per the maintenance schedule. Always use TVS TRU4 FULLY SYNTHETIC oil only (SAE 10W 30 API-SL, JASO MA2).

Fuel leak

If any fuel leak from tank is suspected, tow the vehicle to the nearest TVS Motor Company Authorised Main Dealer / Authorised Dealer.

Tyres

Low tyre pressure has adverse effects on the vehicle. The **drag on the vehicle** increases resulting in decreased fuel economy. Further more, handling may be affected adversely.

 **Caution**

Never drive the vehicle with the clutch lever pressed. This will reduce the life of clutch and affect the vehicle performance and fuel economy.

Do not attempt to do any rectification, as fuel lines are normally pressurized upto 3.5 bar and any activity by any untrained personnel, may lead to un-safe condition.

Check the tyre pressure regularly (weekly) and inflate them to the recommended pressure (refer page no. 103). Never use tyres which are worn out beyond the permissible limit.

Chain slackness

Check and ensure drive chain slackness. Excess slackness leads to higher fuel consumption (refer page no. 107).

Wheels free movement

Check and ensure the free movement of wheels by rotating the them at least once in a week to avoid wastage of fuel.

Fast starting from rest wastes fuel

A racing start from rest at full throttle will waste fuel and damage the engine. It also creates a potentially dangerous traffic situation. Fuel is wasted whenever the rider suddenly accelerate or apply brake.

Avoid unnecessary idling

While waiting for someone or stopping in signals for long time, if the engine is kept running at idle speed, it causes unnecessary wastage of fuel.

Avoid frequent braking

Anticipate corners and slopes as well as the traffic conditions. **Unnecessary and frequent braking reduces the fuel economy.**

Note

The on-road mileage of TVS Apache RTR 160 4V is dependent on several factors like road condition, quality of fuel, riding speed, operation of clutch and brake, tyre inflation, maintenance / timely servicing of vehicle, load etc. and hence will differ from the mileage given under standard test conditions such as made in recognised institutes.

MAINTENANCE SCHEDULE

The maintenance schedule indicates the intervals between periodic services. At the end of each interval, be sure to inspect, check, replace, adjust, lubricate and service as instructed. If the maintenance is not done periodically, it will result in rapid wear and severe damage to the vehicle. If the vehicle is used under high stress conditions such as continuous full throttle operation or is operated in dusty area, certain jobs should be performed more often to ensure reliability of the vehicle. Cylinder head, steering components, suspension, chain and wheel components etc., are key items and require very special and careful servicing. TVS Motor Company Limited strongly recommends that the jobs as per the maintenance schedule be performed by your TVS Motor Company Authorised Main Dealer / Authorised Dealer.

Periodic inspections may reveal one or more parts that may need replacement. Whenever replacing parts on TVS Apache RTR 160 4V, it is recommended that you use only the TVS Motor Company Genuine parts.



Caution

Proper running-in and maintenance are mandatory for making certain that your vehicle is reliable and gives optimum performance at all times. Make sure that the periodic maintenance is performed thoroughly in accordance with the instructions given in this owner's manual.

In more dusty areas, the air filter element required early replacement than the mentioned kilometers to avoid costly damages to the engine.

PERIODIC MAINTENANCE SCHEDULE (months or km whichever occurs earlier)

Item	Service km	In free service					After free service		Remarks
		1st	2nd	3rd	4th	5th	Every	Every	
		500 - 750 1 month	2500 - 3000 3 months	5000 - 6000 6 months	8500 - 9000 9 months	11500 - 12000 12 months	3000 km 3 months	6000 km 6 months	
Engine cum transmission oil		R	I&T	R	I&T	R	I&T	R	
Oil filter (strainer)		C	-	C	-	C	-	C	
Oil filter (paper filter)		R	-	R	-	R	-	R	
Spark plug ¹		I	-	-	-	R	-	-	Inspect and clean if required. Replace every 12000 km
Air cleaner element		I	-	-	-	R	-	-	Replace every 12000 km
SAI hose connections		I	-	-	-	-	-	-	
Tappet clearance		I	-	I & A	-	I & A	-	I & A	Inspect for any noise / starting trouble and adjust if required
Clutch plates		-	-	-	-	-	-	-	Inspect and replace if required every 21000 km
Oil cooler fins		-	-	I & C	I & C	I & C	I & C	-	
Oil cooler pipes		-	I	I	I	I	I	-	Inspect and replace if required every 15000 km
Engine breather hose		I	I	I	I	I	I	-	Replace every 21000 km if required
Fuel filter		I	I	I	I	I	I	-	
Hose fuel with respective clamps		I	I	I	I	I	I	-	Replace every 21000 km if required

¹ Replace every 12000 km or 1 year whichever is earlier

Contd...

Item	Service km Period from the date of sale	In free service					After free service		Remarks
		1st	2nd	3rd	4th	5th	Every	Every	
		500 - 750 1 month	2500 - 3000 3 months	5000 - 6000 6 months	8500 - 9000 9 months	11500 - 12000 12 months	3000 km 3 months	6000 km 6 months	
Throttle grip	-	-	L	-	L	-	L	Lubricate using grease	
Clutch and throttle cable play ²	I, A & L	I, A & L	I, A & L	I, A & L	I, A & L	I, A & L	-		
Steering smooth operation/ play ³	I & A	-	-	-	C, L & A	-	-	C & L with fresh Bechem premium grade 3 grease every 12000 km	
Front fork oil	-	-	-	-	-	-	-	Replace every 18000 km	
Front and rear suspension ⁴	I	I	I	I	I	I	-		
All fasteners	I & TI	I & TI	I & TI	I & TI	I & TI	I & TI	-	Tighten if necessary	
Drive chain**	C, L & A	C, L & A	C, L & A	C, L & A	C, L & A	C, L & A	-	Adjust if necessary	
All bulbs, horn and switches	I	I	I	I	I	I	-	Inspect for proper functioning	
Head lamp beam	I & A	I & A	I & A	I & A	I & A	I & A	-		
Battery voltage ⁵	I	I	I	I	I	I	-		

² Inspect for proper operation and adjust play. Lubricate ends using grease.

³ Inspect for smooth steering rotation, steering shake / noise. Adjust the steering if necessary.

⁴ Inspect for smooth and proper function of front and rear suspension. Also inspect for any visual damage and oil leakage.

⁵ Recharge if necessary

** Clean the drive chain with TVS TRU SPRAY Chain Cleaner and apply TRU SPRAY Chain Lube as frequently as every 500 km for better chain life and smooth vehicle running (refer page 107 for details). Check drive chain, rear sprocket and engine sprocket for wear. If any part is worn, replace the same. Always replace the engine sprocket, rear sprocket and chain together.

Contd...

Item	Service km Period from the date of sale	In free service					After free service		Remarks
		1st 500 - 750 1 month	2nd 2500 - 3000 3 months	3rd 5000 - 6000 6 months	4th 8500 - 9000 9 months	5th 11500 - 12000 12 months	Every 3000 km 3 months	Every 6000 km 6 months	
Brake effectiveness		I	I	I	I	I	I	-	
Brake pedal shaft		L	L	L	L	L	L	-	Lubricate using TRU4 oil
Brake shoe [#] / pad wear		I	I	I	I	I	I	-	Replace if necessary
Brake fluid ⁶		I & T	I & T	I & T	I & T	I & T	I & T	-	
WSS / toner ring		I & C	I & C	I & C	I & C	I & C	I & C	-	Replace if damaged
WSS cable clamps		I	I	I	I	I	I	-	Fix new clamp if found missing
WSS cable		I	I	I	I	I	I	-	Replace if damage
Brake hose / bundy tubes		I	I	I	I	I	-	I	Replace every 30000 km
Bundy tube mounting (all joints)		I & TI	I & TI	I & TI	I & TI	I & TI	I & TI	-	Inspect for leak
HECU mounting cushions		-	-	I	-	I	-	I	Replace every 30000 km
Toner rings teeth damage		I	I	I	I	I	I	-	Replace if necessary
Malfunction indicator lamp		I	I	I	I	I	I	-	Check and resolve the errors using diagnostic tool if the lamp is 'ON' even after starting the engine
Master cylinder cups		-	-	-	-	-	-	-	Replace every 21000 km
Wheel freeness		I	I	I	I	I	I	-	

[#] Applicable for rear drum brake model

⁶ Replace every 21000 km or 2 years whichever is earlier

Contd....

Item	Service km Period from the date of sale	In free service					After free service		Remarks
		1st	2nd	3rd	4th	5th	Every	Every	
		500 - 750 1 month	2500 - 3000 3 months	5000 - 6000 6 months	8500 - 9000 9 months	11500 - 12000 12 months	3000 km 3 months	6000 km 6 months	
Tyre pressure at cold condition		I & S	I & S	I & S	I & S	I & S	I & S	-	
Ball joint gear shift lever		-	-	L	-	L	-	L	Lubricate using grease
Centre / side stand pivot		L	L	L	L	L	L	-	Lubricate using TRU4 oil
Swing arm bearings		-	-	-	-	-	-	-	C & L with fresh Bechem premium grade 3 grease every two years
Wheel balancing ⁷		-	-	-	-	I	-	-	Inspect every 12000 km
Evaporative emission control system		I	I	I	I	I	I	-	Check for intactness of hoses and canister
Fuel tank assembly**		I & C	I & C	I & C	I & C	I & C	I & C	-	

R - Replace; I - Inspect; T - Top up; C - Clean; A - Adjust; DR - Drain; L - Lubricate; TI - Tighten; S - Set

⁷ It is advisable to balance the wheels every 1 year or 12000km and also after every tyre puncture repair or tyre replacement to have better high speed performance.

** Check for abnormal vehicle jerk / noise while opening the cap / leak. If found any, contact TVS Motor Company Authorised Main Dealer or Authorised Dealer.

RECOMMENDED LUBRICANTS

APPLICATION	QTY	MANUFACTURER	BRAND
Engine cum transmission oil	1200 ml (during regular service) 1400 ml (incase of disassembly)	TVS Motor Company	TVS TRU4 FULLY SYNTHETIC oil (SAE 10W30 API-SL, JASO MA2)
Front fork oil	Fork leg LH - 340 ± 3 cc Fork leg RH - 390 ± 3 cc	IOC / HPCL	Front fork fluid
Disc brake fluid	–	TVS Girling	DOT 3 / DOT 4
Grease	–	Bharat petroleum IOC Bechem	MP Grease no. 3 Servo Gem no. 3 Bechem premium grade 3
Chain cleaner	–	TVS Motor Company	TRU SPRAY chain cleaner
Chain lubricant	–	TVS Motor Company	TRU SPRAY

SELF - MAINTENANCE PROCEDURES

BATTERY

To ensure better performance and long life of battery, you are requested to follow the steps given below:

1. Remove the cover frame R (refer page no. 77).
2. Check the battery voltage. If the voltage measured is less than 12.4V, charge the battery using TVS Motor Company Limited recommended battery charger only at TVS Motor Company Authorised Main Dealer / Authorised Dealer.
3. Adding any additional electrical accessories other than TVS Motor Company recommended ones, may lead to disqualification of warranty coverage.

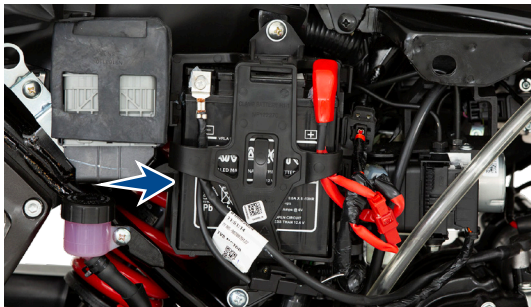

4. While connecting the terminals, observe the correct polarity. Connect the red wire to the '+' terminal and black wire to the '-' terminal of the battery.
5. Apply petroleum jelly to the terminals to avoid corrosion.

In case of any abnormality or for removal of battery from the vehicle, contact TVS Motor Company Main Dealer / Authorised Dealer.

Caution

Never check the battery charge by shorting the terminals. Always connect the positive terminal first (red wire) and then negative (black wire) to avoid sparking.

The inversion of the battery wires can damage the battery and the recharging system.

If the motorcycle is to remain unused for a long time (a month or longer), it is advisable to disconnect the battery cables or have the battery removed by skilled personnel.

Recommendations to maintain battery health during prolonged parking conditions

While your vehicle is parked for prolonged duration, battery continues to discharge and if left unattended can get completely discharged. It is recommended to ride the vehicle for minimum 60 km every week to keep the battery in healthy condition. This could be at a stretch in one ride or several rides during the week.

The vehicle speed will vary during the ride but an average speed of minimum 30 kmph will be helpful to ensure proper battery charging. Use kick-starting, if available, to conserve battery charge during such period. This is only a recommendation to maintain battery charge and regular service schedules must be followed to maintain your vehicle in good running condition.

The following are the recommendations to the users regarding battery maintenance before, during and after long storage of battery:

1. Before Storage

- a. Store the battery only after fully charging it.
- b. Battery fuse to be disconnected and stored safely. This will reduce the sleep mode current and hence enhance storage life of battery.*

- c. Alternatively, battery connecting wires (positive and negative wires) can be disconnected and fasteners can be secured with battery terminals.*

2. During Storage

- a. Store it at room temperature or lower.
- b. Store the vehicle in the shade and protected from rain and cover the vehicle to prevent rodents from entering and damaging the wires.

3. After Storage

- a. Connect the wires and fuse, if disconnected earlier, with ignition switch in 'OFF' position*
- b. Start the vehicle by kick starting.

(Above recommendations do not consider storage effects on other systems such as induction and fuel systems and wheels).

Periodic Maintenance of Batteries:

- Keep top of battery clean.
- Check cables, clamps, and case for obvious damage or loose connections.
- Clean terminals and connectors as necessary.

** To be done by skilled personnel*

- Recharge battery if voltage is below 12.4 Volts.
- Valve Regulate Lead Acid (VRLA) / Lead Acid batteries are prone to water damage. Any water entry, through vents or otherwise; will result in irreparable damage to the battery or the vehicle.

Warning

Battery develop explosive gases. Keep it away from heat sources. If charging is required the battery must be charged in well ventilated area.

Unusable battery must be disposed in environment friendly manner. Do not discard it with household trash. Handover the battery to the battery dealers or to a recycle center that accept used battery.

Caution

Never operate the vehicle with discharged battery as it may damage electrical components.

Do not push start the vehicle, use a good battery to start the vehicle.

FUSE REPLACEMENT

The electrical components of your motorcycle are protected by four fuses. Out of which three fuses are housed inside a fuse box and located below the seat assembly (at left side). One fuse is located below the cover frame near the battery.

To access the fuses located below the passenger seat:

1. Turn 'OFF' the ignition.
2. Park the motorcycle on a flat firm surface and remove the seat assembly as explained in page no. 75.
3. Open the fuse box lid.

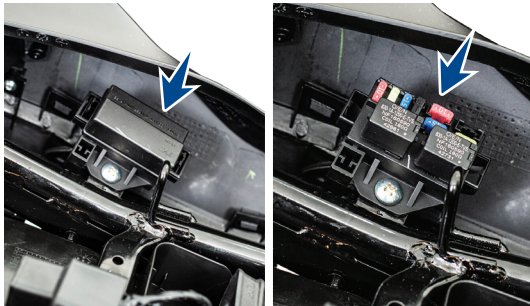

Good Fuse

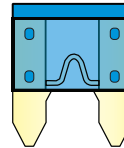

Blown Fuse

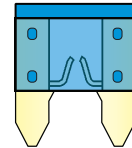

4. The fuse box contains two 15A fuses and one 10A fuse. One 15A fuse is used for ABS system while the other one is used for DC loads. 10A fuse is used for EMS system. Use the fuse puller placed near the fuse box to pull out the blown fuse.
5. Replace the blown fuse with a new one with same rating (extra fuses are provided inside the fuse case itself).
6. Close the fuse box lid and fix back the seat assembly.

To access the fuse located below cover frame:

1. Remove the cover frame R as explained in page no. 77.
2. Open the fuse holder and pull out the blown fuse (Main fuse - 25A).

SPARK PLUG

1. Wipe and clean the dust and mud around the spark plug mounting to avoid their entry inside the cylinder.
2. Pullout the suppressor cap from spark plug.
3. Remove the spark plug using a plug spanner.

A spark plug with heavy carbon deposits will not produce strong sparks. Hence, only if necessary, remove the carbon deposits from the spark plug with a small wire brush or spark plug cleaning tool.

Inspect the spark plug electrodes (A) and (B) for any corrosion. If found any replace the spark plug with a new one.

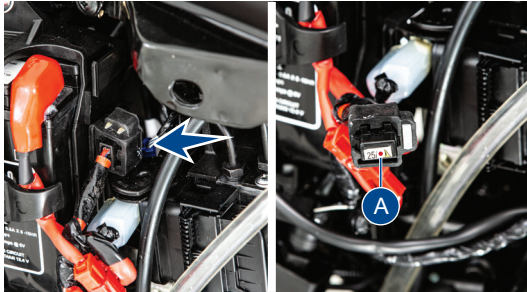

3. Replace the blown fuse with a new one with the same rating (extra fuse (A) is provided in the fuse holder itself).
4. Turn 'ON' the ignition and check for proper functioning of electrical and ABS system. In case if the fuse fails again, consult the nearest TVS Motor Company Authorised Main Dealer / Authorised Dealer.

Caution

Do not use vehicle by **shorting the wires without fuse**. This may result in overheating of electrical items / wiring and may result in fire. Never replace a fuse with a rating other than that prescribed in order to avoid damage to the electrical equipment.

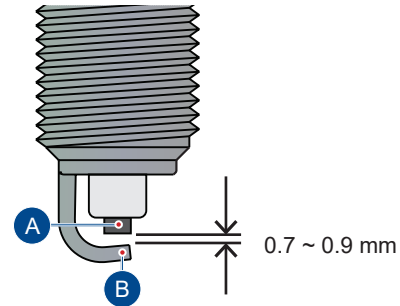

Inspect the spark plug gap visually (0.7 ~0.9 mm). If the gap is found to be more, replace the spark plug with a new one.

After cleaning and inspecting the gap, reinstall the spark plug and tighten by hand to avoid cross threading. Finally tighten using the spanner. Do not over tight or cross thread the spark plug. After reassembling the plug fix back the suppressor cap and ensure its proper fitment.



Caution

*Always use only recommended make and type of spark plug. Since the hook type spark plug is used, it is not advised to adjust the plug electrodes as it may damage the electrodes. **Replace spark plug every 12000 km or 1 year whichever is earlier.***

Cover the spark plug hole with a cloth when the plug is removed to prevent entry of dust / water.

Do not remove the spark plug when the engine is hot. It is advisable to tight the new spark plug by hand till the end and then loose. Again re-tight the spark plug by 1/8 of rotation after sealing by using only the hand tool. Care should be taken not to damage the spark plug cooling duct (ram air duct) during dismantling / assembling the spark plug.

ENGINE CUM TRANSMISSION OIL

Check the engine cum transmission oil level periodically. The gauge oil level is provided at the right-hand side crankcase cover. The check must be performed when engine is in cold condition, after placing the motorcycle in center stand with front wheel touching the ground.



1. Place the motorcycle in an upright position on a horizontal and firm surface.
2. Wipe-off the surroundings of gauge oil level.
3. Remove the gauge oil level and wipe it clean.
4. Re-insert the gauge oil level by completely screwing it in.
5. Once again remove the gauge and check the oil level.

6. The oil level should be between the minimum and maximum level marks on the gauge as shown in the figure.
7. If the oil level is below the minimum level, top up with TVS TRU4 FULLY SYNTHETIC oil (SAE 10W30 API-SL, JASO MA2) upto the maximum level mark. Do not overfill.
8. Wipe out the oil traces with a clean cloth to prevent dust accumulation and re-fix the gauge.

Caution

Do not run the vehicle with insufficient / without engine cum transmission oil as it will cause serious damage to the engine components.

Excessive oil filling will cause oil leak and other malfunctions. Always use TVS TRU4 FULLY SYNTHETIC oil (SAE 10W30 API-SL, JASO MA2) only.

Make sure that no foreign object gets in the crankcase while topping up the engine oil.

Warning

Correctly recycle or dispose the used engine oil in order to avoid environmental pollution.

CLUTCH ADJUSTMENT

Clutch lever free play is one of the most important adjustment which you may need to check in-between services for better life of the clutch plates. The free play of the clutch lever should be 8 ~ 13 mm as measured at the clutch lever end at handle bar before the clutch begins to disengage.

Adjust the clutch lever free play periodically by means of clutch cable adjuster at arm clutch release if the free play is found more.



1. Ensure that the engine is cold (engine oil at room temperature).
2. Loosen the lock nut (2) while holding the clutch cable adjusting nut (1). Adjust the clutch cable adjusting nut (1) 'in' or 'out' to give sufficient play in the clutch lever.
3. After adjusting the play, hold the adjuster nut in the same position, tighten the lock nut (2).



 **Caution**

Too much or too less clutch lever free play will damage the clutch plates, thereby affecting the performance of the vehicle.

Adjust the clutch lever free play only when the engine is cold.

After adjusting free play properly, if there is a clutch slip or there is a difficulty in shifting gear, visit your TVS Motor Company Authorised Main Dealer / Authorised Dealer for rectification.

REAR SHOCK ABSORBER

TVS Apache RTR 160 4V is provided with dual rated, 7 step adjustable, gas filled rear shock absorber to meet different road and load.

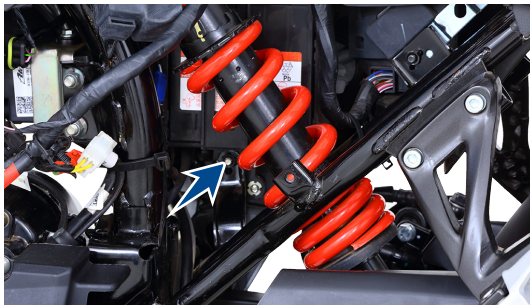

Warning

The rear shock absorber contains highly compressed gas. Do not try to open or disassemble it in any way.

Caution

Adjust step by step. Do not go at a stretch as it will damage the cam.

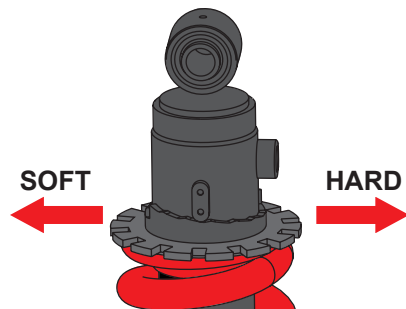

Note

During the time of delivery of the motorcycle, the rear suspension is adjusted to the standard configuration.

Rear shock absorber spring stiffness can be set to your convenience. Contact your TVS Motor Company Authorised Main Dealer / Authorised Dealer for setting the rear shock absorber load.

BRAKES

Front brake

You can observe a master cylinder (1) on the right side of the handle bar, a caliper assembly (2) fitted to the fork leg R along with a wheel speed sensor (3), a disc (4) and the toner ring (5) to the front wheel. Also you can observe a high pressure hose connecting the master cylinder to the HECU of ABS system and another hose connecting HECU to the caliper assembly.

1. Check the master cylinder brake fluid level through the view piece glass (A).

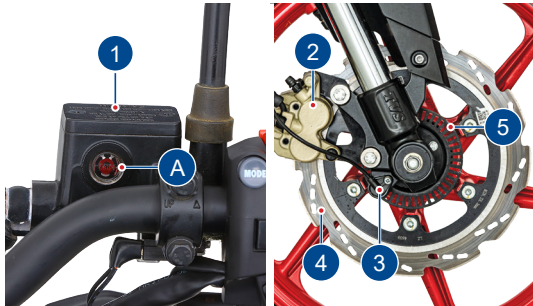

2. Brake fluid level always should be above the 'LOWER' mark (B) on the master cylinder when the master cylinder is parallel to the ground.
3. If the brake fluid level is below the mark or while applying brake or if you feel the brake is more spongy or ineffective due to air entry, contact TVS Motor Company Authorised Main Dealer / Authorised Dealer for topping-up the brake fluid, air bleeding and other brake related inspections.



Note

Check the brake fluid level only when the master cylinder is parallel to the ground.

Rear brake

You can observe a master cylinder (1) mounted on the right side pillion foot rest, a reservoir (2) below the cover frame R, a caliper assembly (3) fitted on the rear wheel axle, a disc (4) to the rear wheel and a high pressure hose (5) connecting the master cylinder to the caliper.

1. Remove the cover frame R (refer page no. 77 for removal procedure).
2. Check the brake fluid level in the reservoir. It should be between maximum and minimum level.

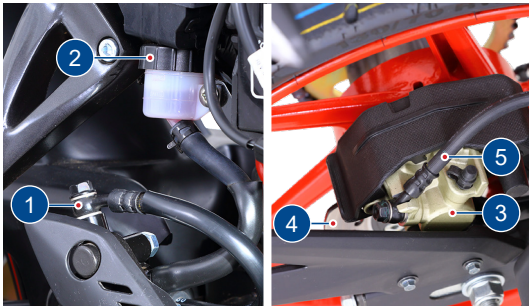

3. If the brake fluid level is below minimum or while applying brake if you feel the brake is more spongy or ineffective due to air entry, contact TVS Motor Company Authorised Main Dealer / Authorised Dealer for topping-up the brake fluid, air bleeding and other brake related inspections.

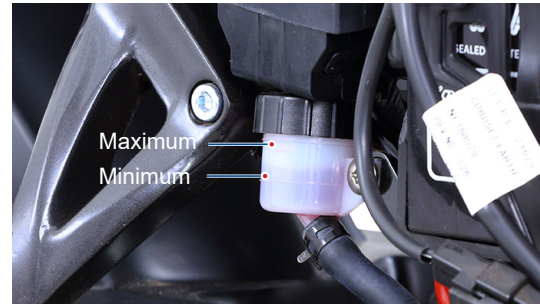

Note

Check the brake fluid level only when the master cylinder is parallel to the ground.

Brake pad wear indicator

Visually check the brake pads for wear. If the wear is found beyond the wear indicator groove as shown in the figure then, replace the brake pads as a set with a new one.

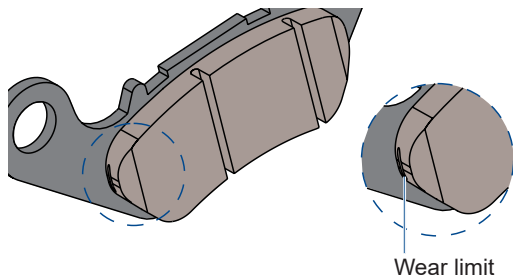

Warning

Lack of maintenance of the brake system increases the risk of accident. If you notice any malfunction in brake system contact nearest TVS Motor Company Authorised Main Dealer / Authorised Dealer.

Caution

Replace the brake pads as a set, if the wear indicator shows beyond the wear limit.

TYRES*

Tyre pressure:

Check the tyre pressure atleast once in a week if not more frequently. Insufficient air pressure in the tyres not only hasten tyre wear, but also seriously affects the stability of the vehicle.

Under-inflated tyres make smooth cornering difficult and over inflated tyres decreases the tyre contact with the ground which can lead to skidding and loss of control. **Lower tyre pressure consumes more fuel.** Be sure that the tyre pressure is within the specified limits at all times.

	Solo	Pillion
Front	1.75 kg/cm ² (25 psi)	1.75 kg/cm ² (25 psi)
Rear	2.00 kg/cm ² (28 psi)	2.25 kg/cm ² (32 psi)

Warning

*The tyre inflation pressure in cold condition and the tyre thread condition are extremely important for the performance and safety of the rider. Check the tyres frequently for inflation pressure as well as the wear pattern on it. **Use of a tyre other than the standard will cause instability.***

Tyre tread condition

Operating the vehicle with excessively worn tyres will decrease riding stability and can lead to loss of control. It is recommended to replace the tyre when the tyre wears off to the tyre wear indicator level (indicated by TWI on the tyre).

Tyre rotation direction

While reassembling the tyre, after removing from wheel rim, ensure that the arrow mark (A) provided on the tyre, faces the direction of wheel rotation.

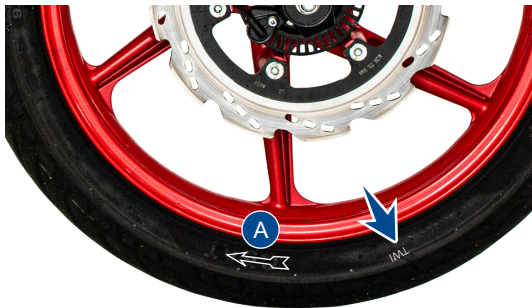

* The pneumatic tyres fitted in this vehicle meet the requirements specified by BIS and comply with the requirements under the Central Motor Vehicles Rules (CMVR), 1989.

Tyre puncture

TVS Apache RTR 160 4V is fitted with a tubeless tyre on both front and rear wheel. In case of any puncture / tyre damage, it is advised to visit nearest tyre manufacturer Dealer or the tyre repair shops who know the repairing methods of tubeless tyre.

It is not necessary to remove the tyre from wheel rim always to attend the puncture, even though if there is a need of tyre removal, it is strongly recommended to use a tyre removal / fitment machine.

If at all, tyre levers need to be used, the levers should be free from sharp edges. Care should be taken not to damage the rims and tyres.

Caution

Side walls of the tubeless tyres which are in contact with the wheel rim are only seals the air inside the wheel assembly. Hence, care should be taken not to damage the side walls of the tyres during removal / reassembly.

It is advisable to balance the wheels every 1 year or 12000 km and also after every tyre puncture repair or tyre replacement to have better high speed performance.

 **Warning**

Use of a tyre other than the standard may cause instability and improper function of ABS.

Keep the toner ring upwards whenever the wheel is removed in order to avoid damage to the toner ring. Damaged toner ring affects the ABS function.

Tyre maintenance tips

Inflation Pressure Check - Condition



Within
1 km



Within
5 km

 Note

If vehicle is in hold condition for long time

- *Need movement of vehicle to avoid particular spot of tyre not to touch the ground for more than week time.*
- *Inflation pressure should check on cold condition maximum travel time should not exceed more than 1 km.*
- *Weekly basis inflation pressure check helps to improve 10% of tread life and fuel efficiency.*

DRIVE CHAIN

Proper lubrication and adjustment of drive chain gives long service life of the chain. Poor maintenance of the chain causes premature wear or damage to the drive chain and sprockets. **Poor chain maintenance also affects mileage of the vehicle.**

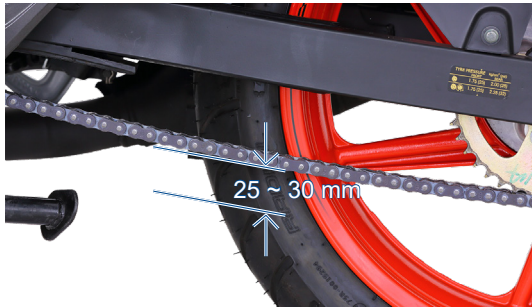

Warning

Riding with improperly adjusted chain / high slackness can cause the chain to come off the sprockets resulting in accident or serious damage to the motorcycle. Misalignment of rear wheel or sprockets can cause abnormal wear of chain and sprockets and results in unsafe riding condition.

The drive chain must be cleaned, checked, lubricated and adjusted at specified intervals mentioned in the maintenance schedule.

Even though the chain is cleaned, lubricated and adjusted during regular service by the Dealers, the user must clean the chain with TRU SPRAY Chain Cleaner and lubricate using TRU SPRAY Chain Lube as frequently as every 500 km for better chain life and smooth vehicle running.

Check, clean and lubricate the drive chain in the following manner:

1. Place the vehicle on centre stand with the transmission in neutral.
2. Clean the chain in the as explained below:
 - Turn OFF the engine.
 - Shake the TVS TRU SPRAY chain cleaner bottle well.
 - Rotate the rear tyre so as the chain, front and rear sprockets rotate along with it. Apply TVS TRU SPRAY chain cleaner front and sideways.
 - Clean the chain using soft brush.
 - Repeat the steps if needed until the dust is removed completely.
 - Let the vehicle be parked for 10 ~15 mins to ensure the chain is dry.

3. After the chain is completely dry, apply TVS TRU4 Chain Lub by rotating the rear wheel by hand in forward direction.
4. Now, check the slackness of the drive chain (as shown). The slackness of the drive chain should not exceed the limit (maximum 25 ~ 30 mm).
Excess slackness consumes more fuel.
5. If the slackness is found more contact TVS Motor Company Authorised Main Dealer / Authorised Dealer for adjustment.

 **Caution**

Lubricate the drive chain after the motorcycle is washed with water or riding in rainy / wet condition.

The chain must be serviced more frequently when the vehicle is operated under severe conditions like dusty, muddy, wet, high speed or frequent starting / stopping.

FRONT WHEEL REMOVAL AND REASSEMBLY

1. Remove the axle nut (1) along with a washer.
2. Pull out the axle (2) along with a washer and remove a spacer from both the sides of the wheel.
3. Place a support below the frame to prevent vehicle from falling and lift the vehicle up.
4. Carefully dislocate the disc from the caliper assembly and slide the wheel out.
5. Reverse the procedure for reassembling.

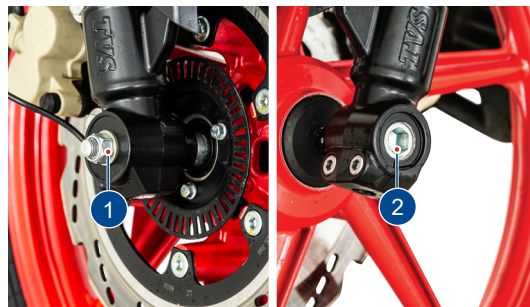

Warning

Ensure proper seating of disc in the caliper assembly while reassembling the wheel. Ensure to re-fix the right spacers at both the sides of the wheel.

Keep the toner ring upwards whenever the wheel is removed in order to avoid damages to the toner ring. Damaged toner ring affects ABS function.

REAR WHEEL REMOVAL AND REASSEMBLY

1. Remove the wheel hugger rear. Remove the axle nut (1) and along with the washer and partially pull out the axle (2).

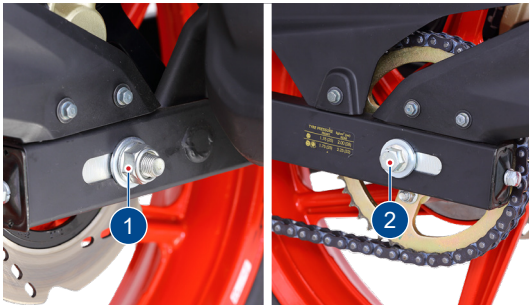

2. Take out the caliper assembly by dislocating it from the disc and the swing arm lug.
3. Carefully hang the caliper assembly in the swing arm itself. Take out the spacer and pull out the axle fully.
4. Remove the wheel assembly by gently tapping it along with the disc.
5. Re-assemble the other parts in the reverse order of removal. During re-assembly, engage the drum sprocket with the wheel along with the drive chain and then assemble the wheel into swing arm.

Caution

While assembling the caliper assembly, ensure that the slot provided in the caliper is properly located to the lug provided in the swing arm assembly. Always make sure that whenever the wheel is removed, axle nut is properly re-tightened to the specified torque and chain play is re checked and adjusted if required.

Note

During removal of rear wheel axle hold the drum sprocket assembly with the hand as it may fall. Carefully hang the drum sprocket along with chain in the swing arm itself.

STORAGE PROCEDURES

For storage of your motorcycle for longer periods of over a month and above, we recommend to carry out the following steps:

1. Clean the vehicle thoroughly. Park the vehicle on centre stand.
2. Warm up the engine and drain engine cum transmission oil. Store the oil, if new, in a dust free container.
3. Empty the fuel tank.
4. Remove the spark plug and feed in several drop of engine cum transmission oil through spark plug hole. Crank the engine few times and reinstall the spark plug.
5. Remove the battery, store it away from direct sunlight and freezing temperatures.
6. Place a suitable support at the bottom of the frame so that both the tyres are off the ground. This will ensure better tyre life.

Warning

The exhaust system becomes hot after a run. Park the vehicle in a place where pedestrians or children are not likely to touch the vehicle.

7. Cover up the vehicle completely with a clean tarpaulin or any other suitable cover. Store the vehicle inside a garage or similar area to avoid damage due to dust and rain. Make sure that the storage area is well ventilated and free from any source of flame or spark.

Caution

Do not park the vehicle on a slope or soft ground or else it may fall.

During storage, the battery must be recharged on a TVS Motor Company recommended battery charger at least once in a month.

TAKING THE VEHICLE OUT OF STORAGE FOR REGULAR USE

1. Take the vehicle out of the garage and clean it thoroughly.
2. Remount the battery after bench charging if required.
3. Fill the engine cum transmission oil (TVS TRU4 FULLY SYNTHETIC - SAE 10W30 API-SL, JASO MA2) and check the oil level using the gauge.
4. Lubricate the parts as instructed in the periodic maintenance schedule.
5. Fill up fresh petrol in the fuel tank.
6. Check and inflate the tyres to the specified tyre pressure.
7. Check and correct the points mentioned in page no. 80.
8. Turn the ignition switch to 'ON' position. Retract the side stand if the vehicle is parked on side stand. Start the engine and allow it to idle for a few minutes and ride out.



Caution

Avoid using alkaline solution like detergent soaps for washing. This may damage head lamp and other lamp assemblies.

RECOMMENDED TIPS WHEN TAKING A LONG TRIP OF MORE THAN 500 KM

- A) Please keep the following items for use in case of emergency:
 1. Complete tool kit / first aid kit
 2. Recommended spark plug one number.
 3. Turn signal lamp bulb one number.
 4. Throttle and clutch cables one number each.
- B) Precautions to be taken for the journey:
 1. Ensure engine cum transmission oil and brake oil level are up to the level.
 2. Adequate fuel in fuel tank.
- C) Check your motorcycle for the following:
 1. Tightness of all bolts and nuts with correct torque value.
 2. Fitness of tyres / tyre pressure / tread depth.
 3. All bulbs, indicators and horn function.
 4. Balancing of wheel
 5. Check for the proper functioning of ABS (through ABS warning lamp)
 6. Smooth functioning of all cables and their free plays.
 7. Smoothness of steering operation.

8. Slackness and lubrication of chain (page no. 107).
9. Front / rear brake functioning and rear brake lamp switch adjustment.
10. Front fork for any abnormality.
11. Spark plug cleanliness and condition of spark plug.
12. Air filter element cleanliness.
13. Correct idling speed.
14. Lubrication of all items mentioned in the periodic maintenance schedule.
15. Intactness of EVAP system hoses and canister.
16. Any other job as necessary.
17. Have your vehicle checked at any TVS Motor Company Authorised Main Dealer / Authorised Dealer.

 **Note**

Ensure the first aid equipments are changed periodically based on the expiry.

 **Caution**

Long journey are to be taken only after the running-in period of 1000 km.

TVS Motor Company Limited ('the Company') give this warranty with respect to the TVS Apache RTR 160 4V manufactured by the Company.

While the Company has taken every care to maintain quality in the manufacture of the TVS Apache RTR 160 4V, the above said warranty is subject to other terms of warranty:

During 5 Years from the date of purchase or during the first 60,000 km of run for the vehicle in the hands of original retail purchaser, whichever is earlier, the parts of the vehicle covered under warranty which prove to the satisfaction of the Company to have a manufacturing defect will be repaired or replaced free of cost.

The Company's obligation under this warranty is limited to repairing or replacing, free of cost, those parts of the vehicle which upon examination by the Company may prove to the Company's satisfaction to have a manufacturing defect, and in such cases the Company's decision either to repair or replace the affected parts will be final. In the event of replacement of parts, the Company also reserves the right to use parts of the same brand as the affected parts or any other brand which is used by the Company in the course of manufacture. All parts replaced under this warranty will become the property of the Company and must be returned to the company.

Limitations of Warranty:

This warranty shall not apply to following condition:

1. Any natural wear and tear, including without limitation, aging.
2. Warranty claims on proprietary items such as tyres, tubes and batteries etc., should be preferred by the user directly on the respective manufacturer, as per their warranty terms and the Company shall not be liable in any manner in respect to the same.
 - Battery warranty for "MF type (Maintenance Free)" is applicable for a period of 21 months from the date of charging or 18 months from the date of sale or 20,000 kms, whichever is earlier.
 - Battery warranty for "Lead Acid type" is applicable for a period of 15 months from date of charging or 12 months from date of sale or 10000 kms whichever is earlier.
3. Parts repaired or replaced under this warranty are warranted only throughout the remainder of the original warranty period.

4. The Company is not liable for any delay in servicing due to reasons beyond the control of the Company or any of its Authorised Main Dealers / Authorised Dealers.
5. In any event, the Company is not liable for indirect, remote, incidental or consequential damages.
6. The Company may make any modification or improvement to vehicles in future production at any time without prior notice and without any obligation to install the same on vehicles previously dispatched for sale.
7. Any claim under this warranty will lie only when the customer:
 - takes his vehicle to an Authorised Main Dealer / Authorised Dealer of the Company and reports the problem he / she felt in the vehicle to enable the Authorised Main Dealer / Authorised Dealer to inspect the same and assess the cause for the reported problems.
 - produces to such Authorised Main Dealer / Authorised Dealer the Service Handbook for the concerned vehicle for verification of relevant details.
8. This is the only warranty given by the Company for the TVS Apache RTR 160 4V. No employee, Dealer or other person is authorised to extend or enlarge this warranty.

 **Warning**

Modifications to this vehicle not approved by the TVS Motor Company may cause loss of performance and render it unsafe for use and disqualifies for warranty coverage also.

Following Toll Free numbers can be contacted for battery related queries if any.

Incase of EXIDE battery, call :- 1800 103 5454

Incase of AMCO battery, call :- 1800 425 0096

Incase of TATA GREEN battery, call :- 1800 419 8888

Incase of AMARON battery, call :- 1800 425 5858

Following Toll Free numbers can be contacted for Tyre related queries if any.

Incase of TVS Srichakra, call :- 04522443300

Incase of JK tyre, call :- 18002581100

Incase of Maxxis tyre, call :- 1800 532 2888

List of parts not covered under warranty

ITEM	WHAT TO CHECK FOR
Normal Maintenance Operations	Engine tune-up, decarbonizing, fuel system cleaning, oil changes, head light focusing, fastener retightening, ignition timing, clutch and brakes as well as other normal adjustments.
Wear and Tear Items	Chain, sprockets, clutch and brake linings, fasteners, shims, washers, oil seals, gaskets, 'O' rings and spokes etc.
Electrical	Bulbs, fuse, AHO, DRL etc.
Service Maintenance Parts	Oil filters, spark plug, air filter, oil and brake fluid
Rubber, Rexine and Plastic Items	All hoses, pipes and plastic aesthetics
Proprietary Items	<p>Battery, tyres and tubes (the warranty terms are subject to our agreement with proprietary OEM)</p> <p>(Battery warranty for "MF type (Maintenance Free)" is applicable for a period of 21 months from the date of charging or 18 months from the date of sale or 20,000 kms, whichever is earlier).</p> <p>(Battery warranty for "Lead Acid type" is applicable for a period of 15 months from date of charging or 12 months from date of sale or 10000 kms whichever is earlier).</p>
Others Factors	Parts of the vehicle getting affected due to atmospheric effect / environmental factors (rusting, paint peel off etc.). However, depending on the vehicle usage condition, warranty would be accepted up to 2 years from the date of purchase.
	Parts of the vehicle which have been tampered with, altered, repaired or replaced by persons not authorised by the Company and which in the sole judgement of the Company affect the performance of the vehicle.

List of parts not covered under warranty

ITEM	WHAT TO CHECK FOR
Others Factors	Parts which are used in conjunction with parts not made or recommended by the Company.
	Parts suffering damage or resultant damage by accident, misuse, negligent treatment, use of bad quality lubricants or impure fuel or by omission to follow the guidance and instructions contained in this owner's manual.
	Vehicles on which engine number or chassis number is deleted, defaced or altered.
	Vehicles on which any warranty service including scheduled paid service is not availed when it falls due (at TVS Motor Company Authorised Main Dealer / Authorised Dealer).
	Vehicles sold or transferred by original retail purchaser. Vehicles used for racing or any competition or used otherwise than for ordinary personal transportation. Vehicles which have been taken out of India. Vehicles affected by natural calamities like flood, earthquake, tsunami, storm etc.,.
	If the vehicle has been used for commercial purpose like taxi or used for rental or hiring or any other purpose other than regular personal transportation.

SERVICE INFORMATION

There are twenty one services for TVS Apache RTR 160 4V during warranty period. Of these, the first five are free services for which labour charges are free. In addition to these five free services, we have a scheme of sixteen pay services. For keeping the maintenance track of your vehicle, free and pay service record sheets are attached in the Service Handbook given to you during the time of your vehicle purchase. Please have the relevant record sheet filled by the Dealer who is carrying out the maintenance service.

For availing any of the twenty one warranty services, please take your vehicle and your Service Handbook to any of our Authorised Main Dealers or any of our Authorised Dealer. After effecting the service, the Authorised Main Dealer or the Authorised Dealer will affix their stamp on the last column of free or pay service record sheet of Service Handbook for your record and reference. An OTP would be sent to customer's registered mobile number. The same to be shared with the servicing Dealer on or before vehicle delivery.

Periodic maintenance always helps good performance of an automobile and our services are planned to keep your TVS Apache RTR 160 4V performing good. **Please note that carrying out the service for your vehicle at scheduled intervals at any of the TVS Motor Company Authorised Main Dealer / Authorised Dealer is necessary for availing of warranty.** And please also remember that, after the services are over, periodic servicing of your vehicle at appropriate intervals, depending upon its extent of use, will keep your vehicle at its best level of performance.

In case you need any clarification or assistance, please feel free to write to us mentioning the frame number, engine number and the date of purchase of your vehicle also the name and place of the Authorised Main Dealer / Authorised Dealer from whom you bought the vehicle and getting it serviced.

Service Department

TVS MOTOR COMPANY LIMITED

P.O.Box No. 4, Harita, Hosur - 635 109,

TAMILNADU, INDIA.

Toll free no. :- 1800-258-7111

PLANNED SERVICE SCHEDULE (kms or month whichever of the two occurs early)

SI. No.	SERVICE	TYPE	Kms	MONTHS
1	1st service	Free	500 ~750	1 month
2	2nd service		2500 ~ 3000	3 months
3	3rd service		5000 ~ 6000	6 months
4	4th service		8500 ~ 9000	9 months
5	5th service		11500 ~ 12000	12 months
6	6th service	Pay	14500 ~ 15000	15 months
7	7th service		17500 ~ 18000	18 months
8	8th service		20500 ~ 21000	21 months
9	9th service		23500 ~ 24000	24 months
10	10th service		26500 ~ 27000	27 months
11	11th service		29500 ~ 30000	30 months
12	12th service		32500 ~ 33000	33 months
13	13th service		35500 ~ 36000	36 months
14	14th service		38500 ~ 39000	39 months
15	15th service		41500 ~ 42000	42 months
16	16th service		44500 ~ 45000	45 months

Sl. No.	SERVICE	TYPE	Kms	MONTHS
17	17th service	Pay	47500 ~ 48000	48 months
18	18th service		50500 ~ 51000	51 months
19	19th service		53500 ~ 54000	54 months
20	20th service		56500 ~ 57000	57 months
21	21st service		59500 ~ 60000	60 months

Note

Free services enables the customer to avail the service at free of labour charges. Charges for the pay service should be borne by the customer. Cost of engine oil, periodic maintenance parts, filter, brake fluids, all types of greases, petroleum jelly, distilled water, chain cleaner, lubricants, coolants, cleaning cloths for both free and paid services are chargeable to the customer.

Please remember that, after the above schedule, periodic servicing of your vehicle at appropriate intervals, depending upon its extent of use, will keep your vehicle at its best level of performance.

DESCRIPTION	TVS APACHE RTR 160 4V (Ride Mode with Dual Channel ABS)
MANUFACTURER	TVS MOTOR COMPANY LIMITED P.B. No1, Bythahalli, Kadakola post, Mysore - 571 311, India.
ENGINE	
Type	Single cylinder, 4 stroke, air cooled, SOHC, fuel injection
Cylinder bore	62 mm
Stroke	52.9 mm
Piston displacement	159.7 cm ³
Compression ratio	10.15 ± 0.3 : 1
Maximum power in kW	12.91 kW @ 9250 rpm (in Sport Mode) 11.5 kW @ 8650 rpm (in Urban and Rain Mode)
Maximum torque in Nm	14.73 Nm @ 7500 rpm (in Sport Mode) 14.14 Nm @ 7000 rpm (in Urban and Rain Mode)
Maximum speed	114 km/h in 5th gear (in Sport Mode) 103 km/h in 5th gear (in Urban and Rain mode)
Engine idling rpm (under warm condition)	1650 ± 200 rpm (in Sport Mode) 1500 ± 200 rpm (in Urban and Rain Mode)
Air filter	Viscous Paper filter
Oil filter	Wire mesh and micronic paper filter
Lubrication system	Forced wet sump
Starting system	Electric starter
Emission norms	BS VI



DESCRIPTION	TVS APACHE RTR 160 4V (Ride Mode with Dual Channel ABS)
TRANSMISSION	
Clutch	Wet - multiplate type
Gear shift pattern	1 down and 4 up
Primary transmission	Helical gears
Secondary transmission	Chain and sprockets
GEAR RATIO	
I gear	2.917
II gear	1.857
III gear	1.333
IV gear	1.050
V gear	0.880
Primary reduction	3.095
Final reduction	3.461
CHASSIS	
Overall length	2035 mm
Overall width	819 mm
Overall height	1111 mm (with visor) / 1050 mm (without visor)
Seat height	800 mm
Ground clearance (unladen)	180 mm (unladen)
Wheel base	1357 mm

DESCRIPTION	TVS APACHE RTR 160 4V (Ride Mode with Dual Channel ABS)
CHASSIS	
Kerb weight (with toolkit and 90% of fuel)	146 kg
Pay load	130 kg
Maximum laden weight	276 kg
Steering angle	35° (both sides)
Caster angle	26 °
Frame	Double Cradle Split Synchro STIFF (DCSSS)
Front suspension	Upside down forks with 37D
Rear suspension	Gas charged mono shock absorber, 7 step adjustable with rectangular swing arm
Trail length	95.8 mm
BRAKES	
Front	Hand operated, 270 mm petal disc
Rear	Foot operated, 240 mm petal disc

DESCRIPTION	TVS APACHE RTR 160 4V (Ride Mode with Dual Channel ABS)
TYRE*	
Front	90/90-17 49P (Tubeless)
Rear	130/70-17 M/C 62P (Tubeless) / 130/70 R17 M/C 62P (Tubeless) / 110/80-17-57P (Tubeless)
Front tyre pressure**	1.75 kg/cm ² (25 psi)
Rear tyre pressure - Solo**	2.00 kg/cm ² (28 psi)
Rear tyre pressure - Dual**	2.25 kg/cm ² (32 psi)
ELECTRICAL	
Type	AC generator
Ignition system	ECU - 3D Ignition timing map
Spark plug	BOSCH - UR4KE
Spark plug gap	0.8 ± 0.1 mm
Battery type	VRLA or Flooded
Battery capacity	12V, 6 Ah
Generator	Fly wheel magneto 12V, 300W / 12V, 180W
Head lamp	12V, LED lamp
DRL / FPL	LED Strip x 1

* The pneumatic tyres fitted in this vehicle meet the requirements specified by BIS and comply with the requirements under the Central Motor Vehicles Rules (CMVR), 1989.

** In cold condition

DESCRIPTION		TVS APACHE RTR 160 4V (Ride Mode with Dual Channel ABS)
ELECTRICAL		
Tail / brake lamp		LED lamps (1W max / 2.5W max)
Turn signal lamp		12V, 10W x 4
Number plate lamp		12V, 5W x 1
Instrument panel		LCD / LED indicators
Horn		12V, DC x 2
Fuse	Main	12V, 25A x 1
	ABS	12V, 20A x 1
	Load	12V, 15A x 1
	EMS	12V, 10A x 1



Caution

Using the bulb other than the specified rating can result in overloading of the electrical system or premature failure of the bulb.

DESCRIPTION	TVS APACHE RTR 160 4V (Ride Mode with Dual Channel ABS)
CAPACITIES	
Fuel tank capacity [#]	12 l
Fuel	BS VI petrol with minimum RON 91 (containing upto 20% of ethanol by volume)
Engine cum transmission oil grade	TVS TRU4 FULLY SYNTHETIC OIL (SAE 10W30 API-SL, JASO MA2)
Engine cum transmission oil qty	1200 ml (during regular service) 1400 ml (incase of disassembly)
Front fork oil grade	IOC / HPCL - Front fork fluid
Front fork oil capacity	Fork leg LH - 340 ± 3 cc Fork leg RH - 390 ± 3 cc
Brake fluid grade	TVS Girling DOT 3 / DOT 4

 **Note**

Specifications are subject to change without notice.

[#] The fuel tank is not a measuring instrument and the capacity of fuel tank may slightly vary from the indicated capacity.

Dear Customer,

It is mandatory under the Motor Vehicles Act to insure all motor vehicles. No motor vehicle can be used in a public place without a valid policy of insurance issued by an authorised insurer. Driving a motor vehicle without any such insurance is an offense under Motor Vehicles Act.

To assist our Customers on their insurance requirements such as the prompt issue and renewal of policies as well as expeditious settlement of claims if any, our preferred insurers are:





ALWAYS USE TVS-M GENUINE PARTS



TVS MOTOR COMPANY LIMITED. P.B. No.4, Harita, Hosur, 635109, Tamil Nadu, India.
Telephone: +91 (4344) 276780. Fax: +91 (4344) 276878 / 277311 www.tvsapache.com