



Owner's Manual

38PS POWER | AERODYNAMIC WINGLETS | RTDSC | BI-DIRECTIONAL QUICK SHIFTER

CRAFTED
BY CHAMPIONS.
CRAFTED
TO CONQUER.

-PRESENTING THE NEW 2024-

Apache
RTR
310

RACING DNA UNLEASHED

#PureRaceCraft

Dear Racer,

Thank you for choosing the TVS Apache RR 310. The most powerful and technologically advanced Apache yet.

The precision racer has been shaped in the wind tunnel, honed on the dyno and perfected over countless laps on the racetrack. The flagship racer is the culmination of the TVS Racing heritage since its inception in 1982. The racing prowess reflects in every straight line and every corner of the track. The Apache RR 310 has been crafted to be the ultimate racer.

This manual explains the features and operations of your TVS Apache RR 310. Please read it carefully and follow the instructions to enjoy the racing experience.

To prolong your journey on the TVS Apache RR 310, we urge you to get your TVS Apache RR 310 services only at TVS Motor Company Authorized Dealers.

Here's to breaking lap records on your Apache RR 310.

TVS Motor Company Limited

A LEGACY OF CRAFTING CHAMPIONS

1982



Our love of racing began when a TVS 50 Moped clocked 105 km/h.

1988/89



AX 100 won the Great Himalayan Desert Rally.

1992/93



Supra won Indian National Rally Championship; Special Rally kit 250 numbers were made and sold.

1993/94



Shogun kicked off scheme bike racing in India.

1998



Shaolin won the Indian National Rally and Supercross Championships.

2000-2005



Fiero won multiple Indian National Rally, Supercross and Road Racing championships.

2005 - TILL DATE



TVS Apache RTR was launched. It started a revolution in racing and continues to dominate with 90% of race wins and multiple national championships.

2007



Won 12 national championships Supercross, Motocross and Rally.

A LEGACY OF CRAFTING CHAMPIONS

2011



TVS Racing won SLADA and Srilanka National Championship in 2011, 2016 and 2017.

2015



TVS leaves its mark as the 1st Indian Manufacturer in Dakar.

2016



First factory team in India to sign a woman rider and launch a dedicated road racing cup for women.

2019



The Apache RR 310 wins Premium category INMRC PS 301 to 400cc. Winner of Baja Aragon.

2020



TVS Racing Enters Asia Road Racing Championship AP 250.

2021



Won 12th INMRC Title Pro stock up to 165cc

2022



TVS Racing partners with PETRONAS. TVS Racing OMC launched in Asia.

THE JOURNEY OF CRAFTING RACING DNA



2005 - Apache 150



2007 - Apache RTR 160



2009 - Apache RTR 180



2016 - Apache RTR 200 4V



2018 - Apache RTR 160 4V



2017 - Apache RR 310



2021 - TVS Built To Order



2023 - Apache RTR 310

A LEGACY OF CRAFTING HISTORY

- 2017-** The TVS Apache Series entered the India book of records for the longest stunting record with 6 hours non-stop stunting.
- 2019-** The TVS Apache RTR series got into the Asia book of records for stunting at highest altitude for the longest time - 14800 feet above MSL for 1 hour 31 minutes non stop.
- 2022-** TVS Apache RR 310 DR-T completed the fastest-in class quarter mile drag race in 11.523 secs.
- 2023-** TVS Apache RR 310 Asia OMC race bike achieved the top speed of 215.9 km/h breaking the top speed record at the Chang Circuit Thailand and 210 km/h at Sugo Circuit Japan. While also setting the lap record in its class at Sugo Circuit Japan with a lap time of 01:37:06.
- 2023-** TVS Apache RR 310 stock production bike created a Indian National Endurance Speed Record completing 3657.92 kms in 24 hours with an average speed of 152 km/h and a top speed of 173 km/h.



TVS
Racing

Apache
RTR 310

TVS
Racing

Apache
RTR 310

CRAFTED BY CHAMPIONS, CRAFTED TO CONQUER.

A machine that's shaped by the wind, honed on the dyno, and perfected on the racetrack.

A track weapon that has shattered records, is now crafted to redefine excellence. The new Apache RR310 is the epitome of #PureRacecraft.

THE WORLD OF APACHE



Every Apachean can register and be a part of the Apache Owners Group, a motorcycling community consisting of over 3,00,000 members. With chapters across the globe, the group embarks on motorcycling adventures of all kinds. From breakfast rides that satisfy your desire to hit the road to weekend rides that build the bond of biking brotherhood and marquee rides that take you to the remotest corners of the world.



Wheelines pop and jaws drop. The Apache Pro Performance is a series of stunt shows like no other. Featuring the most skilled riders in the country, known for breaking records as well as the laws of physics.



To be a part of this brotherhood scan the QR Code.



The Apache Racing Experience brings you closer to the racetrack than ever before. With mentorship from championship winning riders from TVS Racing, this includes classroom sessions as well as training on the racetrack. This is the best arena to hone and perfect your racing skills. It is also the gateway to the prestigious TVS One Make Championship.



Revision:- Rev. 0, 16 September 2024 onwards

Incase you need any Clarification please contact above Dealer

Or

TVS Motor Company's Area Offices (flip over for addresses)

Or

Toll Free Number : 1800-258-7111

Email : customercare@tvsmotor.com

Disclaimer : TVS Motor Company or any of its officials / Authorized Main dealer / Authorized Dealer do not ask customers for bank / card / wallet details / authentication. In case you face any such claim, please report to the relevant local authorities immediately.



CONTACT AT OUR AREA OFFICES

TAMILNADU-1 & 3

1. TVS Motor Company Limited

V Floor, Gee Gee Universal,
No. 2, MC Nichols Road,
Chetpet, Chennai - 600 031.
Phone : 044-28361651/28361654
Email : AO.Chennai@tvs motor.com
AO.Madurai@tvs motor.com

TAMILNADU-2

2. TVS Motor Company Limited

No. 10, 2nd floor,
Shree Shanmugapriya Towers,
Kannuswamy Street,
Behind Hotel Annapoorna,
R S Puram, Coimbatore - 641 002.
Phone : 0422-4350060/2541035
Email : AO.Coimbatore@tvs motor.com

KERALA

3. TVS Motor Company Limited

Ambady Towers, Second Floor,
Door No. 27/631, A6,
Edappally-Pookkattupady Road,
Edappally PO., Cochin - 682 024.
Phone : 0484-2544578/2556938
Email : AO.Cochin@tvs motor.com

KARNATAKA-1 & 2

4. TVS Motor Company Limited

No. 600, Anand Surya, 2nd Floor,
15th Cross, 6th Phase, JP Nagar,
Opp. BMTC Bus Stop,
Bangalore - 560 078.
Phone : 080-26653433
Email : AO.Bangalore@tvs motor.com

ANDHRAPRADESH & TELANGANA

5. TVS Motor Company Limited

Rukumani Towers, First Floor,
No. 3-11-30, Plot No. 11,
Paigha Colony, Behind Anand Theater,
Secunderabad - 500 003.
Phone : 040-27840590/27844419
Email : AO.Hyderabad@tvs motor.com

MAHARASHTRA-1 & 2

6. TVS Motor Company Limited

No. 401, 4th Floor, The Chambers,
Plot No. 4/12/3, Near Ganapati Chowk,
Viman Nagar, Pune - 411 014.
Phone : 020-26632112/26632110
Email : Service.pune@tvs motor.com

MAHARASHTRA-3

7. TVS Motor Company Limited

No. 502B, 6th Floor, B Wing,
Shriram Shyam Towers,
Near LIC Square, Sardar,
Nagpur - 440 001.
Phone : 0712-2569932
Email : Service.Nagpur@tvs motor.com

CHATTISGARH

8. TVS Motor Company Limited

Office No. 526, 527 & 528,
Magneto Offizo,
5th Floor, Magneto The Mall,
Labhandi, NH-6, Raipur - 492 001.
Phone : 0771-4260006
Email : AO.Raipur@tvs motor.com

GUJARAT

9. TVS Motor Company Limited

1208-1213, Shivalik Satyamev,
Below Bopal Over Bridge,
Ambli-SP Ring Road Junction, Bopal,
Ahmedabad- 380 058.
Phone : 079-65443748
Email : AO.Ahmedabad@tvs motor.com

MADHYA PRADESH-1 & 2**10. TVS Motor Company Limited**

No. 211-212, 2nd Floor,
Chinar Incube Business Centre,
Chinar Fortune City,
Near Brindhavan Dhaba,
Hosangabad Road,
Bhopal - 462 026.
Phone : 0755-2499406/2499306
Email : AO.Bhopal@tvsmotor.com
AO.Indore@tvsmotor.com

RAJASTHAN-1 & 2**11. TVS Motor Company Limited**

Plot No. 17-18,
2nd Floor of National Motors Building,
Jhotwara Industrial Area,
Jaipur - 302 012.
Phone : 0141-5150901/5150902
Email : AO.Jaipur@tvsmotor.com
AO.Udaipur@tvsmotor.com

DELHI & HARYANA**12. TVS Motor Company Limited**

D-3 & D-4, 2nd Floor,
Sector - 10, Noida,
Uttar Pradesh - 201 301.
Phone : 011-29834640/29834773
Email : AO.Delhi@tvsmotor.com

PUNJAB & CHANDIGARH**13. TVS Motor Company Limited**

4th Floor, Royal Business Park,
Chandigarh Ambala Highway,
Zirkapur - 140 603.
Phone : 01762-464777/465777
Email : AO.Chandigarh@tvsmotor.com

UTTAR PRADESH WEST & HILLS**14. TVS Motor Company Limited**

D-3 & D-4, 2nd Floor,
Sector - 10, Noida,
Uttar Pradesh - 201 301.
Phone : 011-29834640/29834773
Email : AO.Delhi@tvsmotor.com

UTTAR PRADESH CENTRAL & EAST**15. TVS Motor Company Limited**

1st Floor, Cyber Tower, TC-34/V-2,
Vibhuti Khand, Gomti Nagar,
Lucknow - 226 010.
Phone : 0522-4918300/4918301
Email : AO.Lucknow@tvsmotor.com

WEST BENGAL**16. TVS Motor Company Limited**

Ground Floor & First Floor,
133 A. S. P. Mukherjee Road,
Opp. Tollygunge Police Station,
Kolkatta - 700 026.
Phone : 033-24617096/24617092
Email : AO.Kolkatta@tvsmotor.com

BIHAR**17. TVS Motor Company Limited**

N-Plaza, Jamal Road,
P.S. Kotwali,
Patna - 800 001.
Phone : 0612-2200068/2200069
Email : AO.BNJ@tvsmotor.com

ORISSA**18. TVS Motor Company Limited**

No. 303, 3rd Floor,
Creative Plaza, Rasulgarh,
Bhubaneshwar - 751 010.
Phone : 0674-2580019
Email : AO.Bhubaneshwar@tvsmotor.com

JHARKHAND

19. TVS Motor Company Limited

2nd Floor,
Lucas Service Building,
Argora Bypass Road,
Ranchi - 834 002.
Phone : 0651-2244715
Email : AO.Ranchi@tvsmotor.com

NORTH EAST STATES

20. TVS Motor Company Limited

147, Udayan, Ganesh Guri,
Near Hotel D Courtyard,
R G B. Road, Guwahati - 781 005.
Phone : 0361-2202030/2202031
Email : AO.Guwahati@tvsmotor.com

TVS Motor Company Limited advises you to read this manual carefully in order to familiarise yourself with your motorcycle. In case of any clarification, please contact any of our Authorised Main Dealer.

This manual contains important information about controls and operation, technical features, maintenance and care to be taken to keep your vehicle reliable and safe. We recommend that you strictly follow the instructions in this manual, especially those regarding the running-in period and periodic maintenance.

TVS Motor Company Limited declines any liability whatsoever for any mistakes incurred during the development of this manual. All the information in this manual is valid at the time of publication.

TVS Motor Company Limited reserves the right to make any modifications required due to the ongoing development of their products. In such events it is possible that the relevant part of this Owner's Manual does not apply to your vehicle.

Prior permission of TVS Motor Company Limited is required for quoting, copying or reproducing any part of this Owner's Manual.

This Owner's manual uses a set of symbols with special meanings. They are:

 **Warning**

*Disregarding this message might result in **injury to the rider or deadly accidents.***

 **Caution**

*This message indicates special procedures or precautions to be followed to **avoid damage to the vehicle.***

 **Note**

*This message provides further clarification for **clear understanding of any particular information.***

The terms 'LH' and 'RH' are referred to the motorcycle viewed from the riding position.

Accessories shown in the picture may not be the part of standard equipment.

For your safety, as well as to preserve warranty, reliability and road worthy of your motorcycle, use original TVS Motor Company Limited spare parts only.

In order to ensure the reliability of your product, you are strongly advised to refer our Authorised Main Dealers for any service requiring particular technical expertise.

Skilled personals of our Dealer have the tools required to perform any servicing job to the highest professional standards to ensure smooth running and long life of your motorcycle.

DESCRIPTION	PAGE No.
Running-in Recommendations	1
SAFE RIDING TIPS	2
Safe Riding Recommendations	2
Maximum Permissible Load	5
ACCESSORY INSTALLATION TIPS	6
KNOW YOUR MOTORCYCLE	7
Anti-Lock Brake System (ABS)	7
EMS a Glance	9
Emission Control	10
VEHICLE IDENTIFICATION NUMBER	11
Control Key	12
Location of Parts -	
Vehicle RH Side View	13
Vehicle LH Side View	14
Controls	15
Special Features of TVS Apache RR 310	16
Ride by wire	16
Quick shifter	16
RT slipper clutch	16
TPMS	17
Glide Through Technology (GTT)	17

RTLSC	18
Straight line ABS system	18
Traction control system	18
Cruise control system	18
Wheelie mitigation	19
RTDSC	19
Cornering ABS	19
Cornering cruise control	20
Cornering traction control	20
Slope dependent control	21
Wheelie control	21
Rear lift protection	22

CONTROLS & ITS OPERATIONS	23
Ignition cum Steering Lock	23
Adjustable clutch Lever	24
Switch Assembly LH	25
Rear Brake Pedal	38
Switch Assembly RH	39
Throttle Twist Grip	40
Adjustable front Brake Lever	41

DESCRIPTION	PAGE No.		
Connected TFT Instrument Cluster	42		
Warning and indicator lights	45		
TFT Multifunction display	47		
Menu indication	48		
Ride Mode	49		
Trip Details	64		
My Vehicle	66		
Preferences	73		
TVS CONNECT APP	94		
How to login	95		
First time Bluetooth pairing:	98		
Steps to “Forget This Device” in iPhone	101		
Auto pairing	102		
Digi Docs	104		
Voice Assist	106		
RIDING YOUR MOTORCYCLE	121		
Before Riding	121		
While Riding	123		
Starting the Engine	124		
Moving the Vehicle	125		
Braking	126		
Stopping the motorcycle	126		
		Parking	126
		Fuel Recommendation	127
		Checks and Tips for Better Fuel Economy	128
		GENERAL ADJUSTMENTS	129
		Rear View Mirrors LH & RH	129
		Clutch Lever - Adjustment	130
		Front Brake Lever - Adjustment	130
		ADJUSTABLE SUSPENSION	131
		Front fork adjustment	131
		Rear shock absorber adjustment	134
		Head Lamp Aiming	138
		MAINTENANCE	140
		Maintenance Schedule	140
		PM Schedule - Free service	141
		PM Schedule - pay service	144
		Safety Precautions	147
		Engine Oil Level	148
		Clutch Free Play	150
		Brake Fluid Level	152
		Brake Pad Wear	153
		Rims and Tubeless Tyres	155
		Tyre pressure	155

DESCRIPTION	PAGE No.		
Tyre tread condition	156	Warranty and service	184
Tyre replacement	157	Limitations of Warranty:	184
Tyre repair	158	Service Information	190
Drive Chain	159	Pre-Delivery Inspection	191
Slackness inspection	159	Planned Service Schedule	192
Adjustment	159	PICKUP AND DROP	193
Cleaning	161	TECHNICAL SPECIFICATIONS	194
Lubrication	161	INSURANCE	205
Front Wheel	162		
Rear Wheel	165		
Fuses	171		
Mirror Assembly	174		
Diagnostic Connector	175		
Cleaning your Motorcycle	176		
Storage Procedures	177		
Restoring the Motorcycle to use	178		
Taking Long Trips	179		
GENERAL INFORMATION	180		
Tool Kit	180		
Auxiliary Stand (Paddock Stand)	181		

Running-in Recommendations

Running-in is essential to preserve engine life and performance over time. Twisty roads and gradients are ideal to run in the engine, brakes and suspension effectively. The first 1000 km is a running-in period for your motorcycle.

Maximum engine speed during running-in 0 to 1000 km - below 7000 rpm

During the first 1000 km, avoid the full throttle starts and rapid acceleration, which could expose the engine parts to excessive stress. It is advisable to run the engine at varying load and rpm, though still within recommended rpm limit. Avoid riding at constant engine rpm for prolonged periods.

During initial running, use brakes gently. Do not brake hard or keep brake applied for too long to enable a correct break-in of brake pad friction material against the brake discs.

To allow all the mechanical parts of motorcycle to adapt each another, and to avoid reduction of engine components life, it is advisable to avoid sudden acceleration and running the engine at high rpm for too long, especially uphill.

Check the drive chain frequently and if required adjust it. Also ensure that the chain is lubricated as required to increase its service life.



Caution

On completion of running -in period, scheduled maintenance service should be observed carefully without fail. Failure to comply with this will result in damage to the engine parts and other key parts of the vehicle or shorter engine life.

Keeping to the running-in recommendations will ensures longer engine life and reduce the need for overhauls and re-tuning.



Note

During running-in period, only 'Urban' and 'Rain' ride modes will be available for the rider to select. The other three ride modes like 'Sport' and 'Track' will be available for selection only after the completion of running-in period and enabled by the TVS Motor Company Authorised Service personal.

Safe Riding Recommendations

The following points are applicable for every day usage of your motorcycle and should be observed carefully for safe riding of your motorcycle.

Riding skills and your mechanical knowledge forms the foundation of safe riding practices. We suggest you to practice riding your TVS Apache RR 310 in a low-traffic condition until you are thoroughly familiar with your motorcycle and its controls.

Most of the accidents are the result of inexperience of rider. You must have a valid license that enables you to ride a motorcycle of this kind. Always make sure you are carrying your driving license with you. Avoid lending your motorcycle to the persons who are inexperienced and not holding a valid driving license.

A motorcycle is not designed to provide impact protection, so defensive riding in addition to wearing of protective apparel is very important.

Please do not let the protective apparels give you a false sense of security.

Both the rider and the pillion should always wear an ISI approved, comfortable and **good quality safety helmet** before riding the vehicle. Because, one of the most serious injury that can happen is an head injury. You should also have a good quality goggles to protect your eyes and help your vision.

Avoid wearing loose clothes or accessories that could become tangled in the controls or limit your field of vision.

Riding at proper speed and avoiding sudden acceleration are not only important for safety and low fuel consumption. It is also important for longer life of vehicle and smoother operation.

Avoid use of mobile phones while riding as it could lead to fatal accident.

To prevent or minimise accident, **never consume alcohol or drugs** before or during the operation of your vehicle. Even minimal consumption of these will affect the rider's ability to control the vehicle.

Ride within the law and observe national and local rules. Always respect speed limits. However, adjust your speed according to the visibility, road and traffic conditions.

Be sure about your visibility and do not ride with the blind spot of vehicles or obstruction ahead you.

Take additional care at road junctions, exits of private land, car parks and on the service roads to highways.

Before changing the lanes or take a turn, look over your shoulder and make sure that your way is clear. Do not completely rely on the rear view mirrors; you may misjudge a vehicle's distance and speed, or you may not see it at all.

Always use turn signal lamps when you intend to change lanes or take a turn. Be sure to switch it off after changing the lane or negotiating the corner.

The rider should keep his/her foot on the footrests while riding the motorcycle.

Always hold the handlebars firmly with both hands in order to be ready for sudden changes of direction or in the road surface.

Under no circumstances should both the hands be removed from the handle bar, as it is very dangerous.

While riding in wet conditions, on loose gravels, the ability to maneuver the vehicle will be reduced. Ride smoothly on this conditions. Sudden acceleration, braking or turning may cause loss of control.

On the wet roads, rely more on the throttle to control vehicle speed and less on the front and rear brakes.

Use the throttle judiciously to avoid skidding the rear wheel from too rapid acceleration or deceleration.

On the rough roads, exercise caution, slow down and grip the fuel tank with your knees for better stability.

To get quick acceleration during overtakes, shift to a lower gear to obtain the necessary power.

Do not downshift the gear abruptly at high rpm to avoid damage to the engine due to overrevving.

Avoid unnecessary weaving for the safety of both the rider and other motorists.

While riding on uphill, shift to a lower gears so that there is plenty of power to spare rather than overloading the engine.

Do not downshift the gears in the midst of cornering. Slow down to a safe speed before negotiating a corner.

Hold the vehicle upright as you apply the brake. Progressive application of brake is safer. Never depress the clutch lever while braking at higher speeds.

Riding down hills, while cornering, close throttle and down shift the gear to take advantage of gear box and engine which acts as additional brake. This will avoid loss of control over the vehicle due to over speed.

Do not ride the vehicle with two hands off from the handlebar considering the safety of the rider and the vehicle.

As the vehicle speed increases, the stopping distance also increases. Progressive application of brake is safer.

Fuel (petrol) is extremely flammable and is explosive under certain conditions. Refuel in a well ventilated area with engine stopped and ignition key turned off.

Do not smoke or use cell phones or allow open flame or sparks when re-fueling or servicing the fuel system.

While re-fueling, there may be a chance of fuel drops getting spilled on your skin or cloths. Wash your skin with soap or change your cloths immediately if you come in contact with the fuel.

Always take out the key when you leave your motorcycle unattended.

Do not park the vehicle on a uneven surface or a slope or a soft ground or else the vehicle may fall.

The exhaust system becomes hot after a run even if the engine is turned 'OFF'. Care should be taken not to touch the exhaust system with any part of your body. Park the vehicle in a place where pedestrians or children are not likely to touch the vehicle. Do not park the motorcycle near inflammable material like wood, dry leaves etc.

 **Warning**

This vehicle is designed for use only on streets and other smooth, paved surfaces. Do not use this motorcycle on unpaved surfaces. Such use could lead to skid or other accident.

Do not ride the motorcycle with helmets attached to the hook; the helmets could cause an accident by distracting the rider or interfering with normal vehicle operation.

 **Caution**

Do not place any combustible material like cloth, paper, vinyl bag etc. near the engine area.

Riding the Vehicle with Maximum Permissible Load

Your motorcycle is designed to travel safely over long distances with maximum permissible load. Even weight distribution of loads is critical for preserving the safety features of the vehicle and to avoid trouble when performing sudden maneuvers.

Information on Maximum Load

The total weight of the motorcycle during running including rider, pillion, luggage and additional accessories should not exceed:

299.5 kg.

Arrange your luggage and other accessories in the lowest possible portion (should not affect the ground clearance) and close to the centre of the motorcycle.

Secure your luggage firmly with the motorcycle. Improperly secured luggage may affect the stability. Never attach bulky or heavy objects to the steering head or front mudguard, as this can cause dangerous instability.

Do not insert any material into the gaps of the frame, where they could interfere with the moving parts.

Ensure that the tyres are inflated to the specified pressure (**ref. page 155**) and they are in good condition.

ACCESSORY INSTALLATION TIPS

Use only TVS Motor Company Limited approved accessories.

Take extreme caution while selecting and installing the accessories for your motorcycle.

The addition of unsuitable accessories can lead to unsafe operating conditions. Your friendly dealer will assist you in selecting quality accessories and installing them correctly.

While selecting the accessories, make sure the accessories should not obstruct lighting, steering, suspension and ground clearance.



Caution

This motorcycle was not intended to be equipped with a sidecar or to be used to tow any trailer or other vehicle.

TVS Motor Company Limited does not produce any of those things and not sure about the effects of those accessories on handling or stability. But we can warn that the effects will be adverse and any damage caused to motorcycle and its components by the use of such accessories will not be covered under warranty.

TVS *Racing*

Additional electrical equipments and controls should not exceed the specified electrical system load of the vehicle (capacity of battery and magneto).

Do not change / add any lighting loads. Use only accessories listed by TVS Motor Company Limited.



Caution

Care should taken not to damage the wiring harness of the vehicle to fit additional electrical accessories; which in-turn affects the 'CAN bus' system of the vehicle.

Anti-Lock Brake System (ABS)

Your motorcycle is fitted with an Anti-lock braking system (ABS) which is designed to prevent skidding and help riders to maintain steering control during emergency-stopping situation in dry or wet roads, loose gravels etc.

How does ABS work?

When a rider applies the brakes continuously as he detects a dangerous obstacle in dry or wet roads, loose gravels etc. thus transmitting excessive brake force to the wheel. This excessive force may cause the wheel to stop spinning and leads to loss of grip. With no firm contact between the tire's contact patch and the road surface, the bike becomes unstable and a crash is imminent.

The slipping wheels on a riding surface results in losing control of whole motorcycle which usually occurs in fraction of a second. Restoring traction while keeping the bike balanced is only a result of luck, or extreme training, as is the case of professional stunt riders who drift. Preventing the wheels from slipping due to excessive braking force compensates losing control and help the rider to maneuver the vehicle and to avoid accidents.

So what the ABS does is actually limiting the braking force exerted by the rider by regulating the brake pressure and keep the wheel spinning. Once the imminence of the locking (and therefore skidding) is avoided, the system re-applies the maximum braking force until the next skid is anticipated. By limiting the max force of the braking maneuver, the ABS systems practically allow riders to use the greatest stopping force possible without locking the wheels.

How does the ABS understands the wheel locking?

The ABS uses continuous wheel speed monitoring system; wheel speed sensors and toner rings (pulsar rings) and a Hydraulic Electronic Control Unit (HECU).

During normal operation the ABS works similar to a normal brake, but functions only when the wheel tends to lock up. The speed sensors fitted on both the wheels measures the rotational speed of the wheel, when the wheel speed reduces rapidly i.e. wheel tends to lock, the HECU modulates the pressure in the brake circuit and thereby prevents the wheel from locking.

How the irregular road surface affects the braking?

Humps and irregular surfaces of the road can cause the wheels to lose contact temporarily with the road surface; if this happens the braking force that can be transmitted to road surface is zero.

If the brakes are applied under these condition, the ABS has to reduce the braking force to ensure and maintain the directional stability when the wheels regains its contact with the road surface. At this instant the ABS must reduce the traction, so that the wheels will continue to rotate under all imaginable circumstances, because this is the precondition for ensuring directional stability. As soon as the actual circumstances arises, the system reacts instantly and adjusts braking force accordingly to achieve optimum braking.

Why does brake pedal / lever pulsate during brake application?

Vehicles fitted with ABS uses the conventional brake system during normal operation. But during hard stop the brake pedal / lever feels different, i.e., a rapid pulsation in the brake pedal / lever; This is absolutely normal.

It is not necessary to have this pulsation feel every time the brake is applied. Pulsations are felt only during wheel locking tendency, occurs due to the modulation of pressure in the brake circuit by HECU. Pulsation means that the vehicle is in limit. This pulsation feel also depends on the road condition.

Rear wheel lift

Under very severe and sudden deceleration, however, under certain circumstances it is possible that the ABS unit fitted in your vehicle will be unable to prevent the rear wheel from lifting clear of the ground and flip over.

Severe braking can cause the rear wheel to lift off the ground. When you brake, bear in mind that ABS control cannot always be relied on to prevent the rear wheel from lifting clear of the ground.

Warning

The ABS can apply and release the pressure in the brake circuit much faster than that rider can do with brake pedal / lever to avoid wheel locking, so there is no need to pump the brake, it requires only continuous application.

EMS a Glance

Engine Management System (EMS) of your motorcycle is a self-manipulative system that checks and regulates the proper functioning of all the operations carried out by the engine.

The EMS checks all the factors related to engine operations, i.e. speed of the engine, load, temperature, fuel consumption, etc. There are two major functions performed by the EMS, they are:-

- Provide a spark at the right time
- To meter fuel to the engine in the right quantity.

The EMS is comprised of several sensors and signals required for injection and ignition spark occurrence, and a sensor for information about the oxygen content in the exhaust. Further more, there is an idle speed motor for adjusting and stabilising the idle speed.

The Engine Control Unit or Electronic Control Unit (ECU) is a central part of the EMS, which is virtually the 'Brain' of an engine. It plays an important role of collecting, processing, analyzing and executing the data it receives from various sub-systems (sensors).

Furthermore, an ECU comprises of a computer which uses a microprocessor to process the inputs from various engine sensors in real-time.

Based on the data input, the ECU precisely calculates and delivers the ideal air-fuel mixture. It also regulates the idle speed of the engine and controls the correct delivery of both fuel and spark to the vehicle under various driving conditions.

Optimum functioning of the EMS assures maximum engine power, with lowest amount of exhaust emissions and the lowest fuel consumption. The EMS is also responsible for the smooth and efficient running of the motorcycle.

Emission Control

Source of Emissions

The combustion process of an engine produces carbon monoxide and hydrocarbons. Control of hydrocarbons is very important because under certain conditions, they react to form photochemical smog when subjected to sunlight.

Carbon monoxide does not react in the same way, but is toxic. TVS Motor Company Limited used various components to reduce carbon monoxide and hydrocarbons.

Exhaust emission control system

All the TVS motorcycles are tested in the factory for optimum fuel efficiency and lowest possible CO levels.

While adequate care is exercised at the factory to ensure that the emissions are within the limits, it is essential for the owner to always maintain the motorcycle in good condition by getting it periodically checked and serviced by TVS Motor Company Authorised Main Dealer so that the emission and fuel consumption levels are maintained as per norms.

Factors that may affect motorcycle emission

If the following symptoms are noticed in your motorcycle, have the vehicle inspected by TVS Motor Company Authorised Main Dealers.

- Abnormal jerk
- Difficult to start or engine gets off after starting. Improper idling
- Misfiring or backfiring during acceleration
- After-burning (back firing)
- Poor driveability and poor fuel economy.
- Noise due to sudden escape of gas during opening of fuel tank cap.

Crankcase emission control system

The engine of TVS Apache RR 310 is equipped with a closed crankcase ventilation system to prevent discharging crankcase emissions into the atmosphere. Blow-by gas is returned to the combustion chamber through the air cleaner and the throttle body.

Evaporative Emission Control System

The TVS Apache RR 310 is equipped with an evaporative emission control system which consists of a canister and associated piping. This system prevents the escape of fuel vapors from the throttle body and fuel tank.

VEHICLE IDENTIFICATION NUMBER

All TVS motorcycles are provided with identification numbers for frame and engine. They are the only means of identifying your vehicle from others of the same model and type.

The frame identification number is engraved on the right of the steering head tube as shown (ref. Fig. 01).



Fig. 01

The engine identification number is engraved on the right side of engine as shown (ref. Fig. 02).

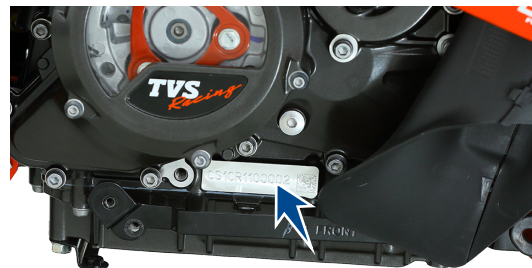

Fig. 02

Note

Do not remove the rust protection cover of the frame identification number from frame

Control Key

Your TVS Apache RR 310 comes with a pair of identical control keys. These keys are to operate ignition cum steering lock, fuel tank cap and seat lock.

A sticker ID (1) attached with keys has the identification number of keys. Please note down the identification number below for future reference. (ref. Fig. 03)

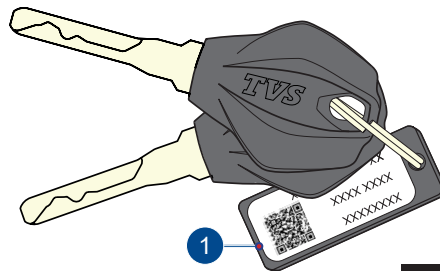
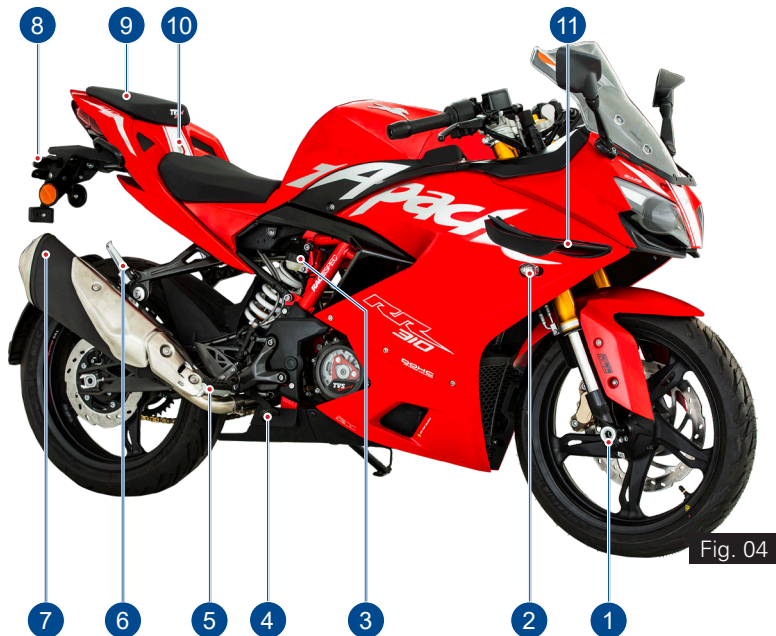

Fig. 03

Location of Parts - Vehicle RH Side View (Ref. Fig. 04)



- 1) Front wheel axle
- 2) Turn signal lamp RH front
- 3) Reservoir, rear brake fluid
(ref. page 152)
- 4) Rear brake pedal **(ref. page 38)**
- 5) Rider foot rest RH
- 6) Pillion foot rest assembly RH
- 7) Muffler assembly
- 8) Turn signal lamp RH rear
- 9) Pillion handle
- 10) Seat lock **(ref. page 119)**
- 11) Winglet R

Location of Parts - Vehicle LH Side View (Ref. Fig. 05)

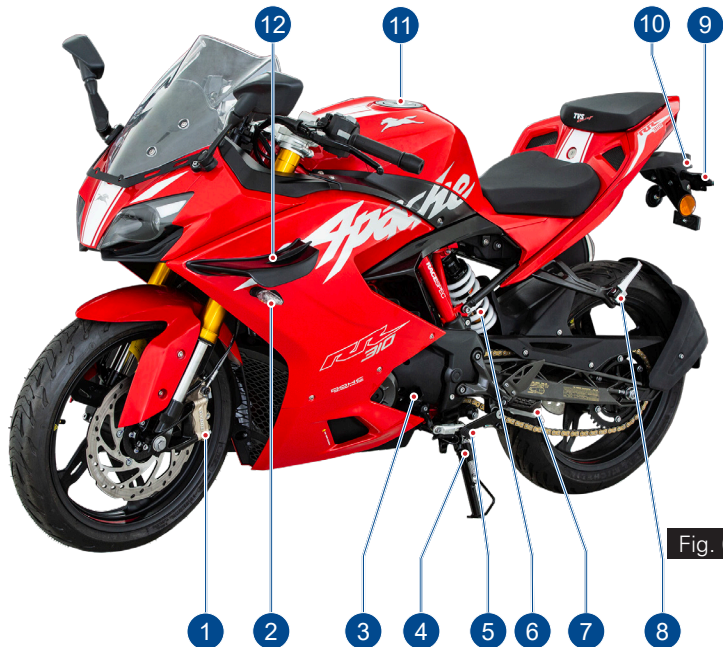

Fig. 05

1. Caliper assembly front
2. Turn signal lamp LH front
3. Gauge oil level (dipstick)
(ref. page 148)
4. Side stand
5. Gear shift pedal **(ref. page 35)**
6. Rear shock absorber
(ref. page 131)
7. Rider foot rest LH
8. Pillion foot rest assembly LH
9. Turn signal lamp LH rear
10. License plate lamp
11. Fuel tank cap assembly
(ref. page 116)
12. Winglet L

Warning

This section shows the position and function of the controls used to ride your motorcycle. Read this section carefully before riding the motorcycle.

Controls (ref. Fig. 06)

- 1) Instrument cluster (ref. page 42)
- 2) Ignition cum steering lock (ref. page 23)
- 3) Adjustable clutch lever (ref. page 24)
- 4) Switch assembly LH (ref. page 25)
- 5) Gear shift pedal (ref. page 35)
- 6) Rear brake pedal (ref. page 38)
- 7) Switch assembly RH (ref. page 39)
- 8) Throttle twist grip (ref. page 40)
- 9) Adjustable front brake lever (ref. page 41)

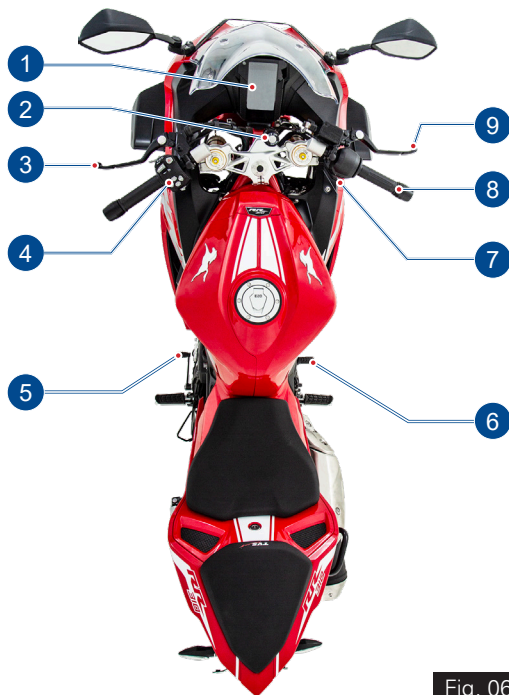

Fig. 06

Special Features of TVS Apache RR 310

Ride by wire

Rider twists the accelerator, actuators in the electronic throttle body senses this movement and change the throttle opening accordingly. The movement of throttle alters air supply to the engine.

Throttle position sensor recognizes this change and sends a signal to ECU. Based on this signal, ECU calculates the exact amount of fuel required and fuel injection system injects fuel accordingly. Hence, engine receives correct amount of air-fuel mixture in every situation.

Quick shifter

Quick shifter helps in vehicle seamless clutch less gear shifting even in city speeds and traffic condition. Quick shifter is tuned to enable seamless up and down shifts without clutch and throttle modulation.

Refer **page 36** for the details of the quick shifter system and its operation.

RT slipper clutch

The 'RT (Race tuned) Slipper Clutch' technology, accentuates the motorcycle's performance and with reduction in clutch force for quicker up shifts, enabling the rider to achieve better lap times. The technology also aims at ensuring rider safety in high speed downshifts, avoids wheel-hopping while cornering, and improves vehicle stability with the back-balance torque limiter effect.

Advantages of RT slipper clutch

- Avoids wheel hopping and provides increase in safety in high-speed downshifts and cornering, improved vehicle stability and balance - back torque limiter effect. Downshifts on muddy, dusty, snowy and wet surfaces is safe.
- Lower clutch operating force.
- Smooth downshifts operation and reduced gear shift force.
- Less bumpy ride in cornering- Slipper clutch absorbs engine braking force.
- No judder noise during sudden clutch launch.
- Reduced gearbox wear and less maintenance.

Tyre Pressure Monitoring Sensor (TPMS)**

The TPMS fitted on both front and rear tyres advertises the pressure value of the tyres to the connected TFT instrument cluster and the cluster will display the corresponding values on the widget if the widget is enabled.

There are four warning levels that will be displayed on the cluster's widget based the pressure level of the wheels.

Refer **page 73 & 89** for enabling the tyre pressure display widget and the details about pressure levels.

Note

TPMS is applicable for select TVS Apache RR 310 BTO versions only. It can be installed as an accessory on payment basis. Contact any of our Authorised Premium Bike Dealers for installing the same.

If the TPMS is replaced by any chance, it should be configured to the instrument cluster of your vehicle to get the tyre pressure indication. Contact any of our Authorised Premium Bike Dealers for doing the needful.

** Applicable for specific Apache RR 310 BTO versions only

Glide Through Technology (GTT)

GTT is a feature for low speed urban riding which enables an extremely smooth and controlled ride.

With this feature, you can start moving the vehicle with a slow release of the clutch lever, without the throttle operation. This is a convenient feature while riding in heavy traffic. The requirement of the synchronization of the clutch lever and throttle grip is eliminated & engine stalling can be eliminated.

The maximum RPM with GTT feature without throttle.

Gear position	GTT rpm	Speed
1st gear	2400 rpm	11 km/h
2nd gear	2500 rpm	16 km/h
3rd gear	2500 rpm	21 km/h
4th gear	2550 rpm	26 km/h
5th gear	2700 rpm	33 km/h
6th gear	2700 rpm	38 km/h

Note

GTT works only in Urban and Rain mode and will not work in Sport and Track mode.

RTLSC (Race Tuned Linear Stability Control)

Straight line ABS system

The ABS has electronic sensors that detects the wheel locking before it happens. Therefore, when you apply brakes, ABS comes into action and alters the braking pressure to prevent the wheel locking. This process helps in maximising the braking performance of your bike.

Traction control system

A traction control system (TC / TCS) is designed to prevent loss of traction (i.e., wheel spin) in the rear wheel especially in low friction surfaces. It controls the engine torque and ensure optimal driving force on the road. It prevents the rear wheel from spinning during hard acceleration, and counteract the front wheel from leaving the ground.

Refer [page 91](#) for the details of the traction control system and its operation.

Key features of traction control system:

- Provides best acceleration without losing stability by rear wheel longitudinal slip control.
- Reduces the risk of uncontrollable large wheelie.
- It can be turned 'ON / OFF' and is adapted to the vehicle ride mode.

Cruise control system

Cruise control (CC) is a comfort function used to control vehicle speed and helps the rider to relax while riding on a open highway.

The rider is responsible for vehicle guidance, in particular lane guidance, adjusting the speed and driving style to match the traffic conditions. The rider can intervene at any time and takeover full control of vehicle operation.

Key features of cruise control system:

While touring or riding for long distances or cruising on highway, riders often like to maintain a constant speed and ride with comfort. However, changes in the road gradient, wind and other factors can make it difficult to constantly ride at a set speed using partial throttle. A cruise control system eliminates this inconvenience and makes the journey on a highway more comfortable and enjoyable. Minimises the riders fatigue. Rider can increase or decrease speeds as per his convenience.

However, it's important to understand that cruise control is not a safety feature and hence not a substitute for safe and responsible riding. Refer [page 91](#) for the details of the cruise control system and its operation.

Wheelie mitigation

Wheelie mitigation is a system that prevents front wheel lift off during acceleration. It analysis the vehicle speed using wheel speed sensor and then mitigating the wheelie by shutting the power.

Key features of wheelie mitigation:

- Prevents large wheelie
- Increased safety during sudden acceleration
- Improved stability while doing wheelie
- Smooth vehicle launch

RTDSC (Race Tuned Dynamic Stability Control)**

Cornering ABS**

Cornering ABS is an advanced safety feature designed to enhance stability and control while braking in turns and corners. When the motorcycle is leaned in a corner, ABS system modulates braking pressure to prevent wheel skid and ensure gradual optimum braking. It also enables the rider to maintain the path of the turn while braking.

By analyzing lean angle input from IMU sensor and wheel slip from wheel speed sensor, the cornering ABS control detects and prevents wheel lockup on individual wheels, allowing the driver to maintain steering control and maximize braking effectiveness, even in challenging cornering situations.

Key features of cornering ABS:

- Improves safety while braking in corners.
- Assists in following the desired path while braking.
- Reduce risk of skidding or losing control in any surface during turns or corners.
- Increases the confidence during braking in all riding scenarios.

** Applicable for specific Apache RR 310 BTO versions only

Cornering cruise control**

Combining the comfort of cruise and safety during cornering, the cornering cruise control is an advanced rider assistance system designed to enhance comfort and control while riding in cruise mode through turns and corners.

By analyzing the lean angle and vehicle yaw input from the IMU sensor, the system detects the turn or corner and accordingly sets the desired speed for that corner. When the motorcycle is running in cruise state and the rider enters the corner, the speed reduces from the set cruise speed which gives enough confidence to the rider to enter the corner without coming out of cruise.

Key features of cornering cruise control:

- Improves comfort by allowing the rider to cruise for long distances.
- Reduces rider fatigue during long distance riding.

Cornering traction control**

Cornering traction control is an advanced safety feature designed to enhance stability and control of the vehicle while accelerating through curves or corners. It optimizes traction and minimizes the risk of skidding or loss of control while accelerating in corners especially in low friction surfaces.

The system works by analyzing inputs from IMU sensor and wheel speed sensor and accordingly modulates the torque delivered to prevent skidding and maximize acceleration.

Key features of cornering traction control:

- Increases stability during acceleration in corners on low friction surfaces.
- Provide riders enough confidence to come out of low friction surfaces with full throttle opening
- Increases safety while corners in low friction road surfaces and off roads.

*** Applicable for specific Apache RR 310 BTO versions only*

Slope dependent control**

Slope-dependent control is a system that detects the slope of the road and modulates the braking force applied to prevent rear wheel lift off and maximize braking in the slope.

On a steep slope, the weight of the vehicle is easily shifted forward, which can cause the rear wheels lift off very frequently. Slope dependent control reduces this lift and ensures optimal braking in slopes.

Key features of slope dependent control:

- Maintains stability during braking in gradients.
- Improves braking performance in gradients.
- Increases the confidence of the rider to brake hard in gradients / slopes.

Wheelie control**

Wheelie control is a system that prevents excessive front wheel lift off during acceleration. It analyzes pitch angle of the vehicle using IMU sensor and then controls the wheelie by modulating the torque delivered.

Key features of wheelie control:

- Prevents excessive large wheelie
- Increased safety during sudden acceleration
- Improved stability while doing wheelie
- Smooth vehicle launch

*** Applicable for specific Apache RR 310 BTO versions only*

Rear lift protection**

Rear lift protection is a feature that prevents the rear wheel from lifting off the ground during hard braking or deceleration. During intense or emergency braking, the weight distribution of the motorcycle shifts forward, causing the rear wheel to lift off. The system analyses the dive of the vehicle using a IMU sensor, detects the tendency of rear wheel lift off and prevents the same by modulating the braking pressure.

Key features of rear lift protection:

- Enhanced braking performance in any terrain.
- Increased safety during panic braking.



Caution

RTLSC and RTDSC features are rider assist features meant to enhance convenience and safety during rides. The features are not a replacement for rider control and will not prevent crashes in extreme conditions, the rider is always responsible for control and stability of the motorcycle.



Note

During Engine / ABS malfunction, RTLSC and RTDSC feature functionality may be limited depending on the type of malfunction. It is strongly recommended to immediately visit any of our Authorised Premium Bike Dealers in case of any Engine / ABS malfunction.

*** Applicable for specific Apache RR 310 BTO versions only*

Ignition cum Steering Lock

Ignition cum steering lock is located in front of fuel tank and has three positions (ref. Fig. 07) :

- OFF (A): Disables lights and engine operation.
- ON (B): Enables lights and engine operation (with engine cut off switch is in run mode ' ).
- LOCK (C): Steering is locked
 - To lock the steering, turn the handle bar all the way towards 'left' or 'right', push the key in and turn it to LOCK position.
 - Push and turn the key to OFF or ON position to unlock.

Note

Control key can't be taken out from the lock at position (B).

The head lamp, tail lamp and license plate lamp will glow automatically when the ignition is turned ON without operating any other switches.

The instrument cluster performs pre-check once the 'ignition lock' is turned ON. Wait till the completion of pre-check.

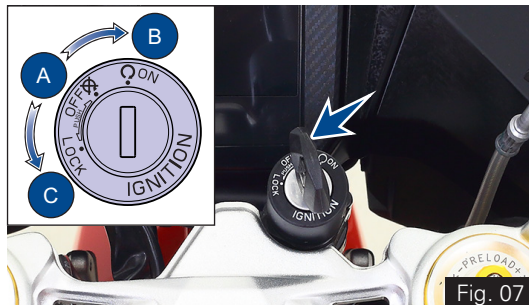

Caution

On level ground, always turn the handle bar towards left while locking the steering when the vehicle is propped with side stand. Else the vehicle may fall and may get damaged. Otherwise the angle of the ground determines the steering position ('left' or 'right').

Always lock the steering while parking for safety.

Ensure that, you do not keep the ignition 'ON' without starting the engine for a long time as battery might get drained because of AHO.

Adjustable clutch Lever (ref. Fig. 08)

Adjustable clutch lever (A) is located in the handle bar at LH side.

- Adjustable clutch lever is used to disengage clutch.
 - When the clutch is pressed, drive from the engine to the gearbox and the rear wheel is disengaged.



Caution

Proper usage of clutch increases the life of engine component and prevent any damage to the transmission components of engine.

- Proper use of clutch lever is essential in all riding situations, especially while moving the vehicle from rest.

Note

Apply the clutch when starting the vehicle with gear engaged.

*Increase in engine rpm during acceleration, without increase in road speed indicates the clutch slip. A slipping clutch causes high fuel consumption and engine overheating. Refer **page 150** for clutch adjustment procedure.*



Use adjustable knobs in clutch lever to suit your finger reach to the clutch lever. Refer page 130 for adjustment procedure.

Switch Assembly LH

Switch assembly LH is located in the handle bar at LH side and has the following switches in it.

A) Switch beam control (ref. Fig. 09)

Head lamp glows automatically when the ignition turned ON. Depending on the selection of High/ Low beam switch position, head lamp will operate in corresponding beam.

- Press the switch towards you '  ' to illuminate low beam
- Press the switch away from you '  ' to illuminate high beam.
 - When the head lamp is illuminated in high beam, the high beam indicator '  ' glows along with it.

Warning

Use appropriate head lamp beam 'high / low' as per the traffic and road conditions for your safety and avoid inconvenience to other riders.



Fig. 09

B) Pass-by switch (ref. Fig. 10)

- Press the switch intermittently to flash the head lamp.
 - Flashing the head lamp high beam provides signal to the vehicles coming from opposite direction during overtakes.
 - If the high beam is flashed, the high beam indicator '  ' also flashes along with it in

the instrument cluster.

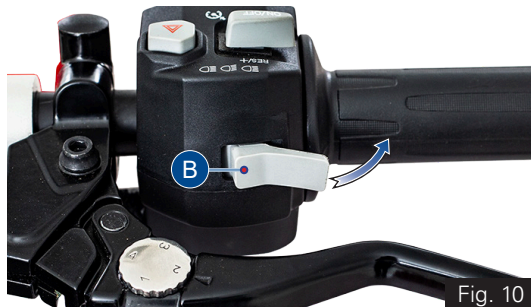

Fig. 10

 **Note**

Pass by works only when the beam control switch is in low beam position.

Similarly, DRL mode works only when switch is in 'Low' beam position.

C) Hazard switch (ref. Fig. 11)

- Press the button '△' (C) to turn ON / OFF the hazard lamps.
 - If the hazard indication is turned ON while the turn signal indicators are active, the turn signal indicators will be suspended temporarily.
 - Turn signal indication will resume automatically once the hazard lamps are turned OFF (if they were active before hazard lamp ON).
 - On activation of hazard lamps, both 'left' and 'right' turn signal indicators '← →' flashes.

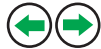

Fig. 11

Note

Hazard lamps can be switched ON/OFF only by means of hazard switch.

Hazard switch works only when the ignition is turned ON and the lamps continue to work even if the ignition is turned OFF during its working.

Avoid using hazard lamps while the engine is turned OFF for prolonging time to avoid battery drain.

C) Cruise control switch (ref. Fig. 12)

Cruise control switch has three operations in it.

Cruise control main switch operation:

- Momentary vertical press of cruise control switch knob turns 'ON / OFF' the cruise control.
 - When the cruise control is activated, the cruise control indicator of the instrument cluster '  ' glows along with it.



Fig. 12

Cruise control 'Set/-' switch operation:

Gentle push of cruise control switch knob towards 'Set/-' position activates the 'Set/-' switch.

- While the cruise control is turned 'ON' (cruise state), you can decrease already set cruise speed in the following manner:
 - Short press (less than 1.5 secs) the knob to decrease the vehicle speed by 1 km/h from original set speed.
 - Long press (more than 1.5 secs) the knob to decrease the vehicle speed by 5 km/h from original set speed with rounding.
- While the cruise control is suspended (stand by mode), the 'Set/-' switch can be used as below:
 - Short press (less than 1.5 secs) the knob to set the current vehicle speed as the cruise control set speed.

 Note

When the cruise control is suspended (stand by mode), long press of 'Set/-' switch knob will not have any impact on the system.

Cruise control 'Res/+' switch operation:

Gentle push of cruise control switch knob towards 'Res/+' position activates the 'Res/+' switch.

- While cruise control is in standby mode, push the switch knob to 'Res/+' position to activate the cruise control.
 - In case cruise control set speed is stored previously, the vehicle will take the stored speed as cruise control set speed.

Note

Rider has to be above the minimum speed of the respective gears to resume the speed.

- In case cruise control set speed is not stored previously, the system takes current vehicle speed as cruise control set speed.
- While the cruise control is turned 'ON' (cruise state), you can increase already set cruise speed in the following manner:
 - Short press (less than 1.5 secs) the knob to increase the vehicle speed by 1 km/h from set speed.
 - Long press (more than 1.5 secs) the knob to increase the vehicle speed by 5 km/h from set speed rounded to the nearest digit.

Conditions for turn 'ON' cruise control:

Cruise control can be switched 'ON' only when the following speed limit conditions are met at respective gear positions.

Gear Position	1st	2nd	3rd	4th	5th	6th
Minimum set speed (km/h)	25	30	35	40	50	50
Maximum set speed (km/h)	125 Urban and Rain mode 135 Sport mode					

To turn 'ON' the cruise control

- Press the cruise control switch when the vehicle speed is more than the minimum allowable speed limit. This will turn 'ON' cruise control and set speed will happen simultaneously.
 - If the cruise control switch is pressed when the vehicle speed is lesser than the minimum allowable speed limit, the cruise control will enter into 'Standby mode' and you need press the switch to 'Set/-' position after crossing the minimum allowable speed limit to enable the cruise control.

Conditions for cruise control suspend / cancel

- According to the accelerator grip position of the vehicle, override operation will be detected by the system and cruise control will be suspended. Vehicle speed will come back to 'SET' speed value after releasing the throttle within 10 secs.
 - Cruise control will be canceled in case the override operation continues more than 10 secs.
- If the accelerator grip position is overclosed to the negative direction (accelerator blip function), cruise control will be cancelled.
- According to the brake lever or pedal operation by the rider, the ABS system of the vehicle detects the braking intention and cancels the cruise control. The cruise control will not be allowed to activate till the brake input is present.
- While the cruise control is active, the rider can use the clutch lever for gear shifting. If the clutch is applied and released within 2 secs, the cruise control will be active. In case the clutch is kept in applied condition for more than 2 secs, cruise control will get cancelled.
- Cruise control will be cancelled if the engine kill switch is activated.

Do's and Dont's while cruise mode is engaged

- Avoid keeping foot on the brake pedal while riding. Any input from the brake pedal will opt out the vehicle from cruise mode.
- Gear shift operation during vehicle ride will not affect the cruise control unless the gear position is changed into neutral. If the gear is shifted to neutral position cruise control will be cancelled and not allowed to be activated.
- Once the cruise mode is suspended, engine braking could be engaged to confirm the rider on the manual ride activation, depending on APS position and engine rpm.

Note

The working rpm range of cruise control is 2700 to 8300 rpm. In case if the rpm range is below or above, downshift or upshift the gear respectively to match with it.

Brake and clutch should be pressed atleast once to enable cruise control after every ignition 'ON'.

Cruise control will not work when there is an active error in EMS or ABS system of the vehicle.

Cruise control will be activated only when the vehicle is in 1st to 6th gear. It will not get activated in neutral gear.

 **Note**

Cruise control set speed is reset at every ignition 'OFF / ON' cycle or every cruise control main switch 'OFF / ON' cycle. The 'SET' target speed will get as long as the ignition and cruise control main switch is kept 'ON'.

In the same key 'ON' cycle if there is no previous set speed then if 'Res/+' is pressed, the current speed is set as cruise speed.

Any input for ride mode change will exit cruise control.

D) Control switches (ref. Fig. 13)

(d1) SET button (ref. Fig. 13)

- Press the button (d1) for selecting the menu display (Ride Mode, Trip Details, My Vehicle, Preferences).
- Press the SET button to enter / select.
- Press the SET button to accept an incoming call.

(d2) DOWN button (ref. Fig. 13)

- Press the button (d2) changing the current selection.
- Long press the button (d2) to activate voice assist.

(d3) RETURN button (ref. Fig. 13)

- Press the button (d3) to exit the current menu and go back to the previous menu.
- Press the RETURN button to reject an incoming call.

(d4) UP button (ref. Fig. 13)

- Press the button (d4) directly from the home screen to toggle the ride modes.
- Press the UP button for changing the current selection.



Warning

Display setting to be done only when the motorcycle is stationary. Never operate the control switches while riding the motorcycle for safety.

Usage of the control switches while riding, should be avoided for a safe ride.

Based on different states, the menu buttons have different operation as shown in image

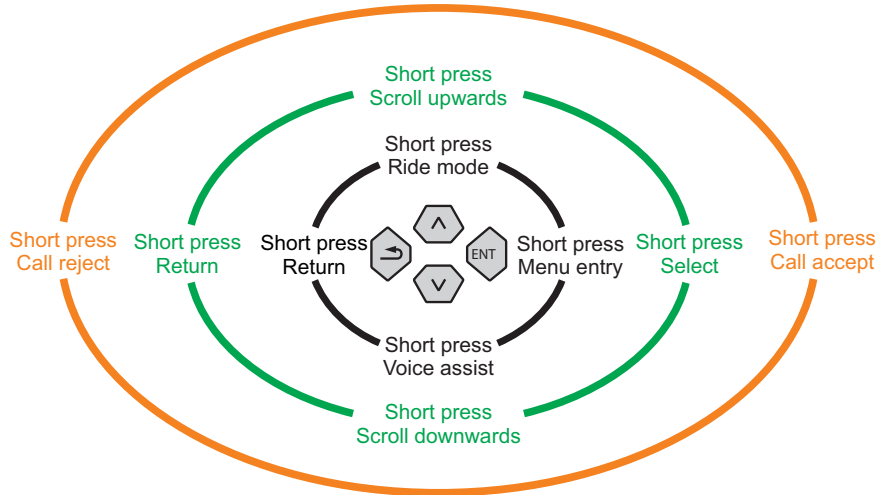

- Default
- Menu
- Call

E) Switch turn signal (ref. Fig. 14)

- Push the switch towards ' ← ' to flash LH side turn signal lamps and towards ' → ' to flash RH side turn signal lamps.
- Push the switch 'IN' to cancel.

- When the 'left' or 'right' side turn signal lamps are activated, respective turn signal indicator ' ← → ' flashes along with it in the instrument

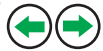

cluster.

F) Switch horn (ref. Fig. 14)

- Press the switch ' 📢 ' to blow horn.

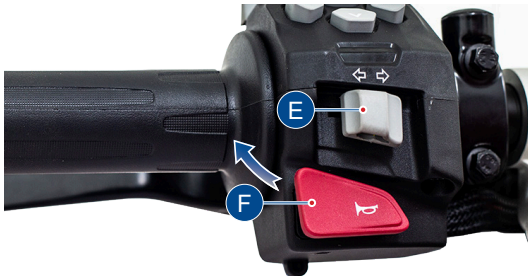

Fig. 14

Gear Shift Pedal (ref. Fig. 15)

This motorcycle is equipped with a 6 speed constant mesh transmission.

- To select the required gear or to bring the vehicle to neutral, a gear shift lever (A) is provided and it is located on the LH side of the vehicle.
- To engage the 1st gear and to down shift the gear press the pedal down.
- To engage the 2nd, 3rd, 4th, 5th and 6th gear, lift the pedal upwards.
- Each time you move the pedal you will be engaging the next gear.

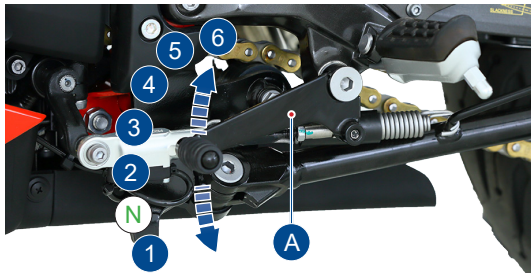



Fig. 15

- Gear shift pedal returns to its position (centre position) automatically when released after shifting.
- Once the transmission is brought to neutral position, the neutral indicator '  ' illuminates.

Note

Apply the clutch when starting the vehicle with gear engaged.

Gear shift pedal position can be adjusted as per the convenience of the rider. Please visit your near buy TVS Motor Company Authorised Main Dealer

Quick Shifter

Quick shifter sensor (QSS) senses the gear shifting force applied on the gear shift pedal by the rider and signals the Engine Control Unit (ECU). The ECU automatically increases / decreases the torque of engine for a pre-set time period to enable the shift gear without applying the clutch.

In 'Urban' mode

Upshifting condition:-

- While riding the vehicle at slow speed (crawling) without applying the throttle, while the engine rpm is greater than 2300 rpm and when the engine temperature is 50 degree and above upshifting is possible.
- Gear upshift works only with open throttle. While shifting do not close or blip throttle.
- There will not be any delay between gear to gear change during upshifts with wide open throttle.
- During cruise control, upshifts can be done throughout the cruise speed.
- In manual traction control (MTC) intervention, upshift is possible at any friction surface (low to high) only with open throttle.

Downshifting condition:-

- Downshifting is possible with and without throttle opening at any engine rpm.
- During cruise control downshift can be done throughout the cruise speed.
- In manual traction control (MTC) intervention downshift is possible at any friction surface.

In 'Sport' mode

Upshifting condition:-

- Upshifting of gear is possible only in throttle opening condition and engine rpm is above 3000 rpm from cold engine temperature. Do not close or blip throttle during gear shifting.
- There will not be any delay in power feel between gear to gear change during upshifts with wide open throttle.
- During cruise control, upshifts can be done throughout the cruise speed.



Caution

The QSS is very sensitive to improve your joy of ride. Avoid keeping foot on the gear lever while riding. Any input from the gear lever will result in upshift or downshift of gear.

- In manual traction control (MTC), upshift is possible at any friction surface (low to high) with open throttle only.

Downshifting condition:-

- Downshifting is possible with and without throttle opening at any engine rpm.
- During cruise control downshift can be done throughout the cruise speed.
- In manual traction control (MTC) downshift is possible at any friction surface.

Quickshifter working RPM:

Mode			
Urban	Rain	Sport	Track
Above 2300 rpm		Above 3000 rpm	

Note

For your flexibility of usage and customized ride experience, quick shifter can be turned 'ON / OFF' in menu. By default, the quick shifter is always ON every time the ignition is turned 'ON'.

Quick shifter will not work when the vehicle is in stationary condition or if the engine speed is less than 2300 rpm in urban mode / 3000 rpm in sport mode. After crossing above engine speed limits & vehicle in motion, clutch need not be applied for gear up / down shifting.

Upshift and downshift using quickshifter will be seamless when the engine temperature is above 50 degrees, this is to allow the oil to warm up and attain optimal viscosity for seamless gearshifts.

Rear Brake Pedal (ref. Fig. 16)

Rear brake lever (A) is located on the RH side of the vehicle.

- Push down the rear brake pedal with your right foot to operate the rear brake.
 - The system is operated by hydraulic and just need to push the lever gently.

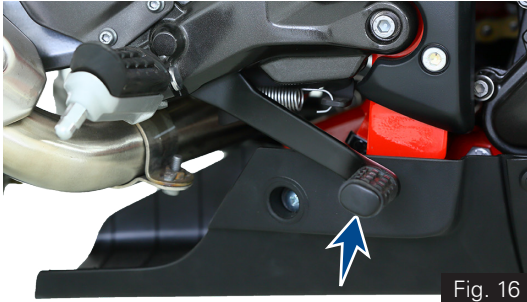

Note

Front brake lever and rear brake pedal pulsates during the hard application of brake which is normal. This pulsation occurs because of ABS working.

Switch Assembly RH

Switch assembly RH is located in the handle bar at RH side and has the following switches in it. Switch electric starter with Engine Kill switch (ref. Fig. 17)

This motorcycle is provided with integrated switch electric starter with engine kill switch.

- The engine kill switch is used to switch off '⊗' the engine but to keep other DC system active.
- The ignition circuit is disabled, preventing the engine from being started. To restart the engine, return the switch to the '⊙' position.
- To start the engine keep the switch in '⊚' position, Ensure the transmission is in neutral or else press the clutch lever before engaging the starter switch.

⚠ Warning

Do not operate the kill switch when riding else you may fall due to rear wheel locking.

This switch is mainly intended for use in emergencies when you need to stop the engine quickly.



Fig. 17

👁 Note

If the electric starter switch is pressed more than 3 seconds continuously, the starter motor gets disabled automatically and will not crank the engine. The motor cranks the engine only after 1 second or if the switch is released and repressed again.

Note

Please remember that the electric starter function will work only when the throttle opening is less than 30%.

Release the electric starter switch immediately after engine starts.

Starter switch will not work if it is pressed when the engine is running.

It is possible to start the vehicle with the side stand ON and gear box in neutral. When starting the bike with the gear engaged, apply the clutch (the side stand must be up in this case. If the side stand is in ON position, after vehicle start engine stops while changing the gear from neutral).

Throttle Twist Grip (ref. Fig. 18)

Throttle twist grip (A) is located in the handle bar at RH side.

- Twisting the grip opens the throttle.
 - Throttle grip spring back to the initial position (idling speed) when released. (ref. Fig. 18)

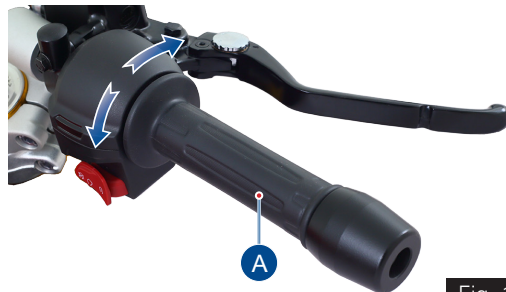

Fig. 18

Adjustable front Brake Lever (ref. Fig. 19)

Adjustable Front brake lever (A) is located in the handle bar at RH side.

- Pull the lever towards the throttle twist grip to operate the front brake.
 - The system is operated by hydraulic and just need to press the lever gently.



Fig. 19

Note

Use adjustable knobs in the brake lever to suit your finger reach to the brake lever. Refer **page 130** for adjustment procedure.

CONNECTED TFT INSTRUMENT CLUSTER KEY FEATURES (ref. Fig. 20)

- Your motorcycle is fitted with a 5" TFT instrument cluster.
- It has an advanced UI /UX design for TFT screen with cognitive ergonomics.
- The cluster has 4 different themes for 4 different rides in Day & Night modes which give you a rich user experience.
- The TFT cluster in combination with infotainment switch enables you on-the-go mode selection.
- In-built photo-sensor helps to automatically adjust the brightness and change the day and night mode of the screen if it is in AUTO.
- User alerts are made easy and effective with warnings and messages on the screen.
- Layout, font size, colors and themes enable quick and easy data access.

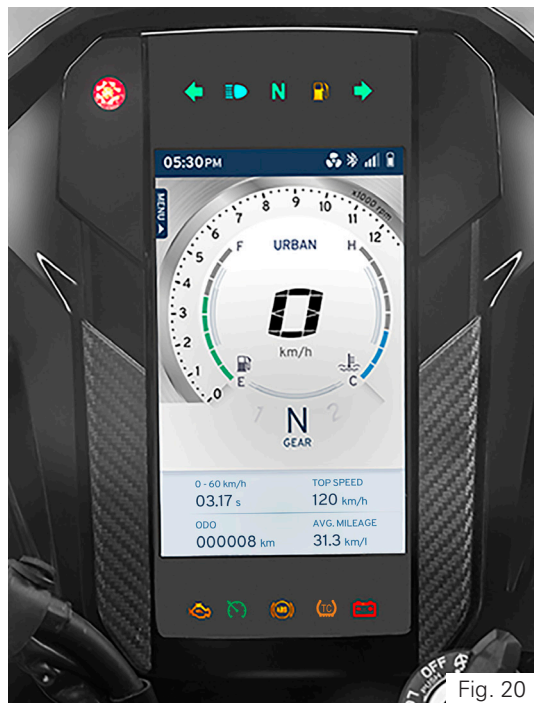

Fig. 20

 **Warning**

Risk of accident through the use of integrated information systems and communication devices during the journey.

Operate these systems or devices only if the traffic situation allows. If necessary, stop and operate the system or devices at a standstill.

TFT Instrument Cluster

Instrument cluster will be activated once the 'ignition lock' is turned ON.

All segments and tell-tale indicators glow for 2 seconds on activation of instrument cluster for checking and ensuring the proper working of segments and indicators.

Following are the features of instrument cluster:

1) Warning and indicator lights (ref. Fig. 21)

- A) Photo sensor
- B) Turn signal indicator LH
- C) High beam indicator
- D) Neutral indicator
- E) Low fuel warning indicator
- F) Turn signal indicator RH
- G) Low battery indicator
- H) Traction control indicator
- I) ABS indicator
- J) Cruise control indicator
- K) EMS malfunction indicator

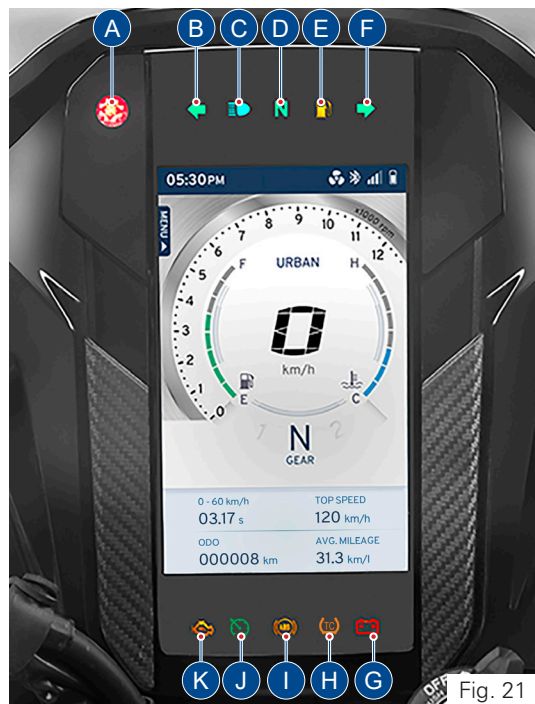





Fig. 21

Warning and indicator lights (ref. Fig. 20)

Symbol	Lights	Meaning
	A. Photo sensor	Adjusts the TFT brightness and tell tale indicators brightness automatically as per day and night conditions.
	B. Turn signal indicator LH	Flashes when the left side turn signal indication is activated
	C. High beam indicator	Glowes when the head lamp high beam is activated
	D. Neutral indicator	Glowes when the vehicle is in neutral condition
	E. Low fuel warning indicator	Glowes when the fuel level in the tank reaches to minimum safe level or any malfunction in the fuel level sensor*
	F. Turn signal indicator RH	Flashes when the right side turn signal indication is activated
	G. Low battery indicator	Glowes when the battery voltage is low*

* Contact TVS Motor Company Limited Authorised Main Dealer

Symbol	Lights	Meaning
	H. Cruise control indicator	<p>Will be 'OFF' when cruise control is disabled and having any error in the system.</p> <p>Blinks when cruise control is enabled and in standby</p> <p>Glowes when the cruise control is in cruise, active, suspend / override and when rider takes control.</p>
	I. ABS indicator	<p>Flashes when the ABS self-diagnostic not completed / not yet initiated - Ride the vehicle few kms.</p> <p>Glowes continuously when the ABS has an error or malfunction*</p> <p>Goes OFF after few kms run - ABS is active and ready to use</p>
	J. Traction control indicator	Glowes / blinks when the traction control is activated.
	K. EMS Malfunction indicator	<p>Glowes when any problem is detected in the engine management system causing vehicle to exceed on-board diagnostic emission threshold.*</p> <p>Blinks continuously when engine mis-fire is detected once the engine is started (mis-firing detection is applicable only for OBD II vehicle)*.</p>

Note

The vehicle automatically goes to reduced performance mode if the engine temperature is very high.

* Contact TVS Motor Company Limited Authorised Main Dealer

2) TFT Multifunction display (ref. Fig. 22)

- A) Menu indication
- B) Clock
- C) Cooling fan status
- D) Bluetooth connectivity indication
- E) Mobile signal strength
- F) Mobile battery status

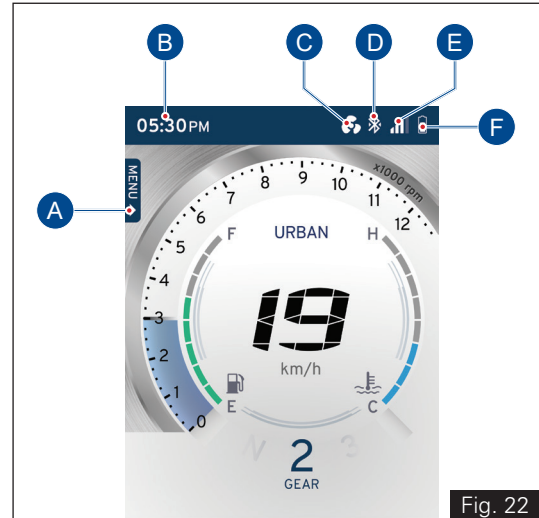
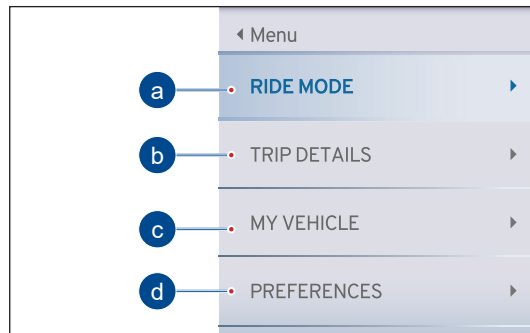

Fig. 22

A) Menu indication

TVS Apache RR310's connected instrument TFT cluster offers you different function of display to choose. The sequence of the functions, their selection and their working are explained in the following pages.

- a). Ride Mode
 - b). Trip Details
 - c). My Vehicle
 - d). Preference
- Displays the menu selected by the user.
- To set the menu:
- Keep the vehicle stationary and switch ON the ignition. After the self-check press the 'SET' button, (ref. Fig. 08 for possible menu display)



Note

For your safety, it is not allowed to navigate through the menu which is not of high importance while riding the bike.

Once your vehicle goes above a speed of 5 kmph, the sub-function (MY VEHICLE) get locked.

a) Ride Mode

In 'RIDE MODE' you have four different types of modes in display to choose the desired ride mode using UP and DOWN button. Press the 'SET' button to select the chosen ride mode.

The modes are explained in the following pages in the below sequence.

- a1. Urban Mode
- a2. Rain Mode
- a3. Sport Mode
- a4. Track Mode

Note

The above mode changes are possible only when the throttle is fully closed.

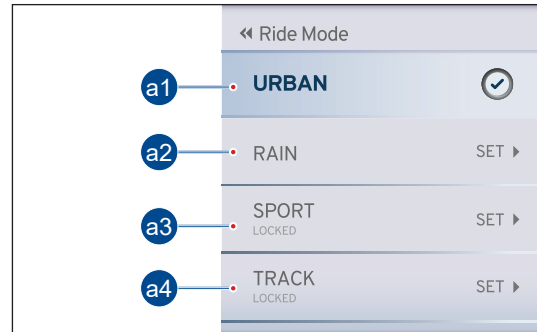

You can access SPORT & TRACK mode only after completing the running-in period, i.e., first 1000 km.

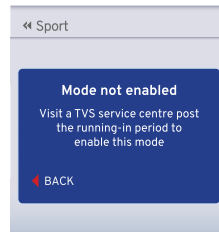
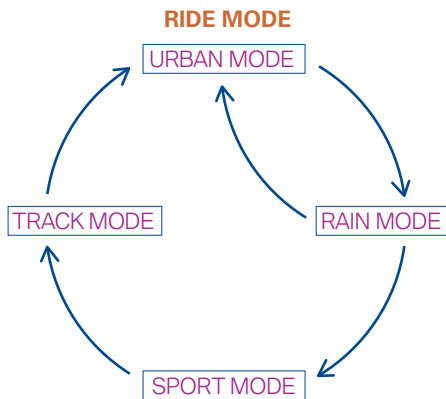

Once you cover the running-in period, Contact TVS Motor Company Authorised Main Dealer for enabling the locked modes.

Note

On ignition ' OFF ' and ' ON ' the previously displayed mode will be retained in display of the connected TFT instrument cluster.

In order to improve performance, consistency and durability of your motorcycle, the maximum vehicle speed will be reduced during the initial running-in period (1000 km).

Caution

In case any fault is detected with respect to the ride mode change in the EMS or ABS system, then your motorcycle will operate only in the URBAN mode.

a1. Urban Mode

Urban mode has been associated with 2 different themes for day and night modes.

Day Mode



Night Mode



Note

Please note that the top speed for Urban mode is limited to 125 kmph and also ABS performance is tuned for Urban mode and will be different for other modes.

If you desire to ride your motorcycle at a speed higher than the above-mentioned value, ensure to change the ride mode to Sport or Track mode. For further details, visit TVS Motor Company Authorised Main Dealer.

a1.Urban Mode

In Urban mode, the following features will be displayed on the instrument TFT cluster :

- e1. Speedometer
- e2. Engine rpm indicator
- e3. Fuel level indicator
- e4. Low fuel warning indicator
- e5. Low battery warning indicator
- e6. Widgets indicator
- e7. Kill switch indicator
- e8. Side Stand warning indicator
- e9. Gear position indicator
- e10.Coolant temperature indicator
- e11. Cruise control indicator

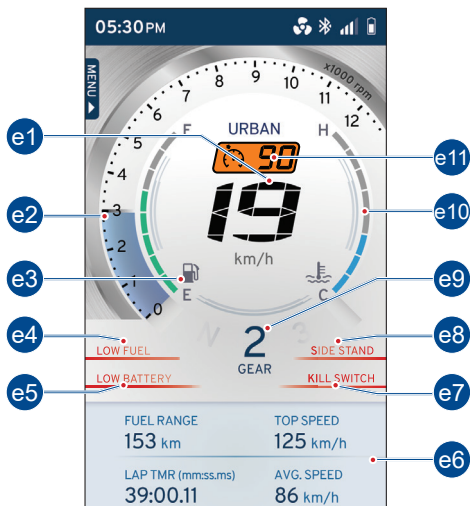

e1. Speedometer

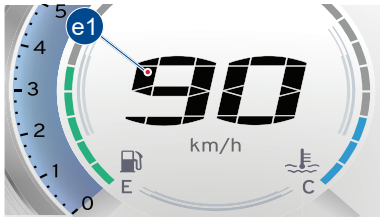

- Displays the road speed in km/h (e1) (in India) .

e2. Dynamic engine rpm indicator

- Digital band (e2) indicates the engine rpm in multiples of 250 rpm.

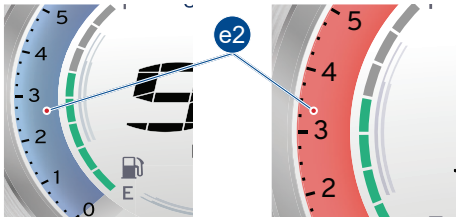

- Digital bands are indicated in blue and red band based on the engine coolant temperature. Refer bellow table for details.

Engine Coolant temperature	Blue band RPM range	Red band RPM range
-25°C to 20°C	0 - 5000 rpm	5000 - 12000 rpm
20°C to 60°C	0 - 7000 rpm	7000 - 12000 rpm
60°C to 120°C	0 - 10500 rpm	10500 - 12000 rpm
Above 120°C	Engine will cut-off.	

e3. Fuel level indicator

- Digital bars (e3) indicates the approximate quantity of fuel available in the tank.

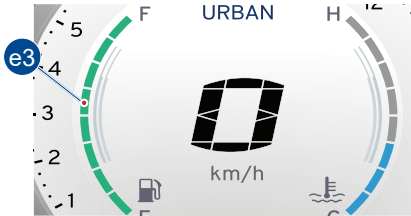

- There are eight bars to indicate the quantity fuel.
- All the eight bars will be displayed when the fuel level in the tank reaches approximately 9 liters.



- When the fuel level reduces to 5 liters (approx.) the indicator displays only five bars.



- If the fuel level is less than 2.2 liters, the low fuel indicator '  ' starts glowing.

- If the fuel level reaches to minimum safe level ie. lesser than 2 liter approximately, fuel level indicator displays a single bar.

- Fill fuel (**ref. page 116**) immediately.



Note

Please ensure that the fuel bar indication in cluster is greater than 1 bar always. It is unsafe to ride with 1 bar or less.

Incase of any error in input system, all the bars of fuel level indicator flashes and low fuel warning indicator turns ON. Contact nearest TVS Motor Company Authorised Main Dealer incase any of these problems are noticed.

Warning

If the vehicle runs with very less fuel it will result in improper engine operation or shutdown due to lack of fuel which may result in accident.

Caution

Do not run the fuel tank dry to avoid failure of fuel pump and other consequential damages if any.

e4. Low fuel warning indicator

- Low fuel warning indicator (e4) is a safety indicator to caution you to fill the petrol as soon as possible. Minimum 2.2 liters of petrol will be available in the tank when this indicator comes glows.

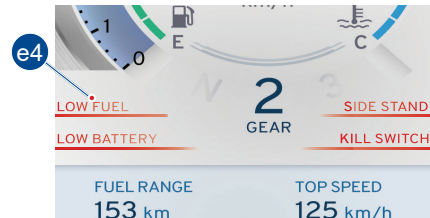



Caution

When the low fuel warning indicator glows fill fuel immediately to avoid engine OFF / Damage to fuel pump which leads to replacement of pump without warranty.

e5. Low battery warning indicator

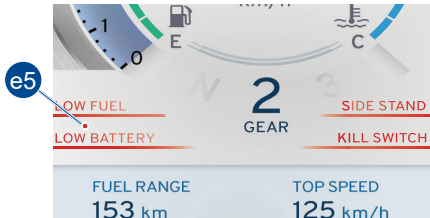
- Low battery warning indicator (e5) appear when the battery charge is too low. Get the battery checked at TVS Motor Company Authorised Main Dealer.



- While riding if there is any fault in the charging system, then a warning message will be displayed on the TFT screen as “VISIT TVS SERVICE CENTER” and along with this the low battery indicator  also blinks (**ref. page 44**).



- When this warning message occurs take the vehicle immediately to TVS Motor Company Authorised Main Dealer.

Caution

If this warning message occurs the vehicle can be ridden for approx. 25 kms or 40 minutes only (which depends on the state or health of the battery).

e6. Widgets indicator

- Widgets (e6) indicates the (viz. ODO, IMI, Avg. Speed, Avg. Mileage etc.) can be used to display live feeds in the home screen of your TFT instrument cluster.

e6	FUEL RANGE	TOP SPEED
	150 km	125 km/h
	ODO	AVG. SPEED
	99999.9 km	95 km/h

Note

To change the widgets in the home screen of your TFT instrument cluster (ref.page 83).

e7. Kill switch indicator

- When the ignition is ON but engine is OFF condition the kill switch indicator (e7) will display in connected TFT instrument cluster.
- It is a safety feature that can be used to cut power to the engine in the event of an emergency.

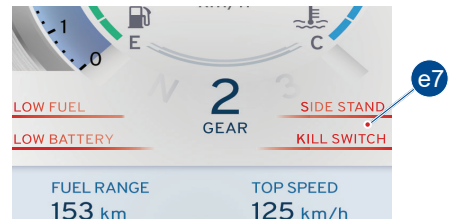

e8. Side stand warning indicator

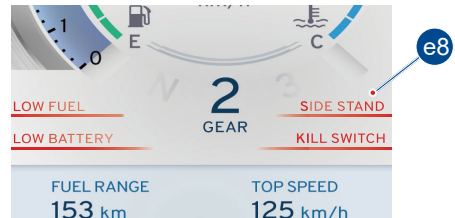

- If the side stand is ON, the text message (e8) will be displayed in connected TFT instrument cluster.

Note

The vehicle will start in side stand in neutral gear but not in other gears. The vehicle will also 'switch off' if the side stand is ON and gear is changed from neutral to gear.

Incase of any errors in side stand switch - side stand indication will be always ON in the instrument cluster immaterial of side stand status.

In the event of any unfortunate accident, if the side stand / side stand switch has been damaged, the signal can be bypassed by disconnecting the side stand switch coupler.

e9. Gear position indicator

- Gear position indicator (e9) indicates vehicle's present gear position and neutral condition. Gear position indication displays “-” if there is any problem in the system. Take the vehicle to TVS Motor Company Authorised Main Dealer.

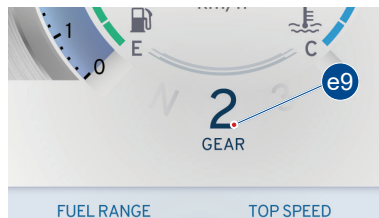

e10. Coolant temperature indicator

- Digital bars (e10) indicates the engine coolant temperature.



- The coolant temperature indicator displays more than six bars if there is any problem in the cooling system.



- In case of any error in input system, all the bars coolant temp indicator flashes.
- Take the vehicle to TVS Motor Company Authorised Main Dealer for further diagnosis.

Note

The vehicle automatically goes to reduced performance mode if the engine temperature is very high.

e11. Cruise control indicator

- Cruise control indicator (e11) will be 'ON' and glows in green colour when the cruise is control is in cruise mode / active, in suspend / override condition and when the rider takes control.
 - Blinks in amber colour when the cruise control in enabled and in standby mode.



Note

Cruise control indicator will be 'OFF' when it is not active and if there is an error in the system.

Cruise control will not work in 'Track' mode. An error message "CRUISE CONTROL IS NOT AVAILABLE" message will be displayed if the cruise is turned on in 'Track' mode.

a2. Rain Mode

Rain mode has been associated with 2 different themes for day and night modes.

Day Mode



Night Mode



Note

All the features are similar like Urban mode. Refer urban mode for the detailed explanation.

Although, vehicle performance will be changed due to the change in ride mode. In rain mode top speed of the vehicle is limited to 125 kmph.

If you desire to ride your motorcycle at a speed higher than the above-mentioned value, ensure to change the ride mode to Sport or Track mode. further details visit TVS Motor Company Authorised Main Dealer.

a3. Sport Mode

Sport mode has been associated with 2 different themes for day and night modes.

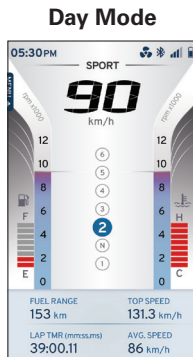

Note

All the features are similar like Urban mode with some notable changes in the UI (graphics). Refer urban mode for the detailed explanation. Although, vehicle performance will be changed due to the change in ride mode.

In sport mode top speed of the vehicle is limited to 160 kmph.

You can access SPORT & TRACK mode only after completing the running-in period, i.e., first 1000 km. Once you cover the running-in period, Contact TVS Motor Company Authorised Main Dealer to enable the locked modes.

a4. Track Mode

Track mode has been associated with 2 different themes for day and night modes.

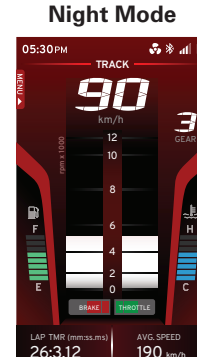
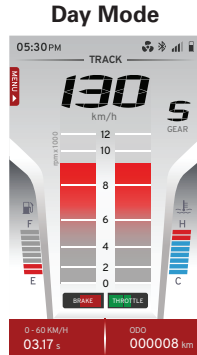

Note

All the features are similar like Urban mode with some notable changes in the UI (graphics). Refer urban mode for the detailed explanation. Although, vehicle performance will be changed due to the change in ride mode.

In track mode top speed of the vehicle is limited to 160 kmph. There is a reduction in the number of widgets (2 Nos.) when compared to the other ride modes.

You can access SPORT & TRACK mode only after completing the running-in period, i.e., first 1000 km. Once you cover the running-in period, Contact TVS Motor Company Authorised Main Dealer for enable the locked modes.

b) Trip Details

- Displays the menu selected by the user.

To set the menu:

- Keep the vehicle stationary and switch ON the ignition. After the self-check navigate to 'TRIP DETAILS' in menu and press the 'SET' button to select the following function.

◀ Menu	
RIDE MODE	▶
TRIP DETAILS	▶
MY VEHICLE	▶
PREFERENCES	▶

- Totally 4 trip meters namely Trip A, Trip B, Trip C and Day trip meter are available.

◀◀ Trip Details	
TRIP A	SET ▶
TRIP B	SET ▶
TRIP C	SET ▶
DAY TRIP METER	SET ▶

- Trip details such as distance covered, time traveled, average speed, top speed, fuel consumed and average mileage are recorded by the trip meter for individual journeys.

« Trip A	
TOTAL DISTANCE COVERED 9999.9 km LIMIT REACHED	TOTAL TIME TRAVELLED 12 : 18 : 42 hh:mm:ss
AVG. SPEED 95 km/h	TOP SPEED 122 km/h
FUEL CONSUMED 999.9 litres	AVG. MILEAGE 33.2 km/l
RESET ▶	

- You can reset it whenever you wish to record the data for new journey.
- Press the DOWN button; RESET option gets selected. Then press the 'SET' button to reset the trip details.
- Press the 'Return' button to menu display (**ref. page 32**).

- Day trip meter recorded the trip details such as distance covered, time traveled, average speed, top speed, fuel consumed and average mileage on that particular day.

« DAY TRIP METER	
TOTAL DISTANCE COVERED 159.9 km	TOTAL TIME TRAVELLED 06 : 18 : 42 hh:mm:ss
AVG. SPEED 99.7 km/h	TOP SPEED 122 km/h
FUEL CONSUMED 4.9 litres	AVG. MILEAGE 33.2 km/l
RESET ▶	

- The values will get reset in case of change in date and long idle i.e more than 4 hours.
- You can reset it whenever you wish to record the data for new journey.
- Press the DOWN button; RESET option gets selected. Then press the 'SET' button to reset the trip details.

Note

Add trip meter as a widget to see the trip ODO value (ref. page 83).

c) My Vehicle

- Displays the menu selected by the user.

To set the menu:

- Keep the vehicle stationary and switch ON the ignition. After the self-check get into menu and select the 'MY VEHICLE' and press the 'SET' button to select the following function.

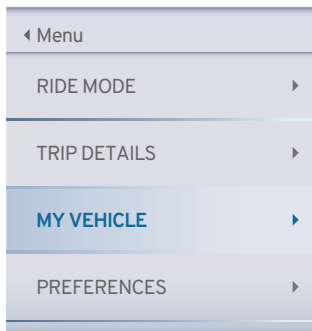

- There are 2 option available in the 'MY VEHICLE'.
 - ◆ SERVICE
 - ◆ PERFORMANCE RECORD
 - ◆ DOCUMENTS
- ◆ **SERVICE**
By press the 'SET' button on select the SERVICE option.

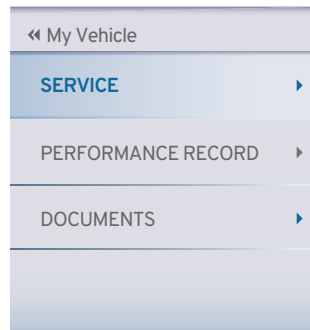

- Upcoming service date for your vehicle will be disclosed in the service menu.
- In addition to that, days and kilometers from last service will be also displayed.
- Press the 'Return' button to menu display **(ref. page 32)**.

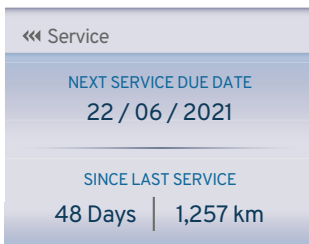

Note

'SERVICE DUE' notification will pop-up on your cluster if your motorcycle is either 300 km ahead of the recorded service kilometers or 7 days prior to the service date.

In case you fail to service your motorcycle within the prescribed date and kilometers, 'SERVICE OVERDUE' message will be displayed on the cluster.

◆ PERFORMANCE RECORD

- Press the down button to select the PERFORMANCE RECORD and press the 'SET' button to select the following function.

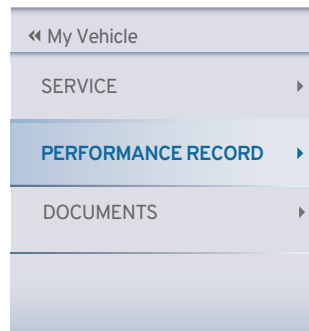

- There are 3 options available in the 'PERFORMANCE RECORD'.
 - ◆ MILEAGE
 - ◆ SPEED
 - ◆ LAPS
- ◆ MILEAGE
- By pressing the 'SET' button on select the MILEAGE option.

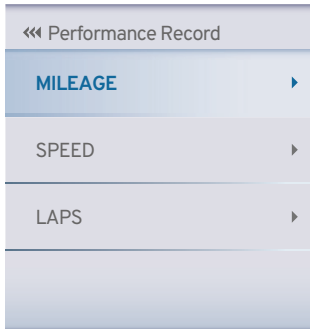

- Average mileage of your vehicle will be calculated and displayed for your knowledge.



- Since this data is resettable, you can reset it if you wish to. Press the DOWN button; RESET option gets selected. Then press the 'SET' button to reset the mileage details.

- ◆ SPEED
- Press the down button to select the SPEED and press the 'SET' button to select the following function.

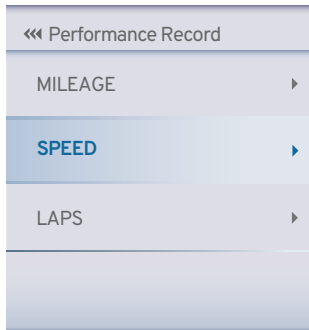

- In this menu, average speed, time taken for 0-60 km/h and top speed of your motorcycle are disclosed.

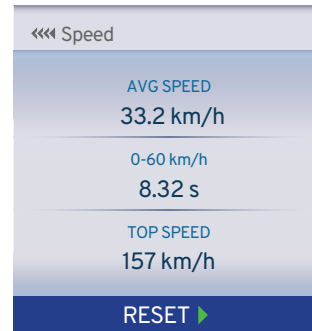

- Since this data is resettable, you can reset it if you wish to. Press the DOWN button; RESET option gets selected. Then press the 'SET' button to reset the speed details.

- ◆ LAPS
- Press the down button to select the LAPS and press the 'SET' button to select the following function.

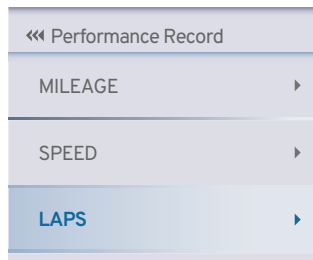

- The cluster of your motorcycle can store a maximum of 10 laps along with the date and time when the lap was triggered.
- 'Best lap' duration is shown based on the 10 lap durations displayed.

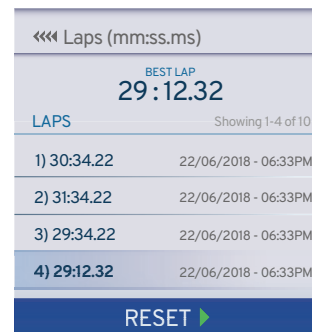
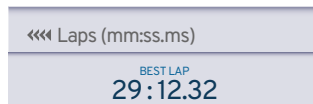

- Since this data is resettable, you can reset it if you wish to. Press the DOWN button; RESET option gets selected. Then press the 'SET' button to reset the Laps details.

◆ DOCUMENTS

Documents such as Driving license, RC book, Aadhar card etc. from TVS Connect app to TFT Instrument Cluster using both Android and iOS mobile phones **ref. page 104.**

- Press the down button to select the DOCUMENTS and press the 'SET' button to select the following function.

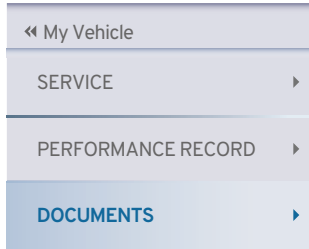

- In this menu, list of documents uploaded from your smart phone through TVS connect app can be seen

- Press the 'SET' button to open the desired documents.

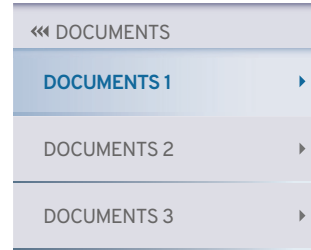

- Press the 'SET' button after selecting the VIEW option, to either view the status of image transferred or image itself after it is transferred.

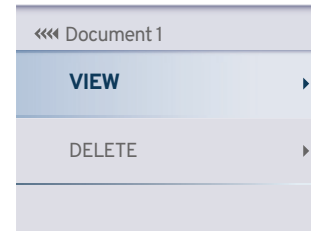

- Press the down button to select the DELETE and press the 'SET' button to delete the document.

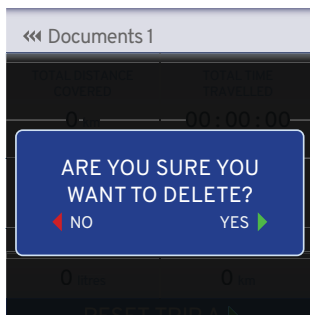
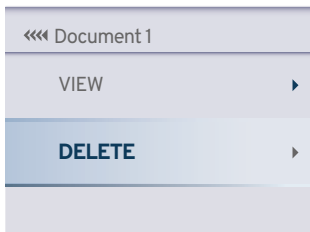

Note

Total of 3 documents can be stored in the TFT Instrument cluster.

Document transfer will work only when VIN number in the TVS Connect App matches vehicle VIN.

Document transfer cannot be initiated once app is connected for ride.

Ride can be connected when image transfer is in progress but 'Start Tour' functionality will not work when document transfer is in progress.

Rate of document transfer may vary, based on type of mobile and software version.

When ride is connected and document transfer is also ongoing, rate of document transfer may be reduced.

In case if document is transferred partially and deleted from TVS Connect App, please ensure that document is also deleted from cluster before syncing the new document in the same slot in cluster.

In case of IG on/off during document transfer, document transfer will not resume until user clicks on resume button in TVS Connect App.

d) PREFERENCES

- Displays the menu selected by the user.

To set the menu:

- Keep the vehicle stationary and switch ON the ignition. After the self-check press the down button to select the 'PREFERENCES' and press the 'SET' button to select the following function.

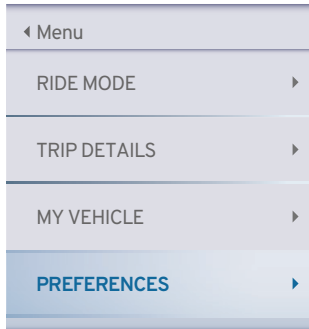

- There are 4 option available in the 'PREFERENCES':
 - ◆ CONNECTIVITY
 - ◆ DISPLAY SET UP
 - ◆ CUSTOM WIDGETS
 - ◆ SPEED ALERT
 - ◆ TRACTION CONTROL
 - ◆ QUICKSHIFTER

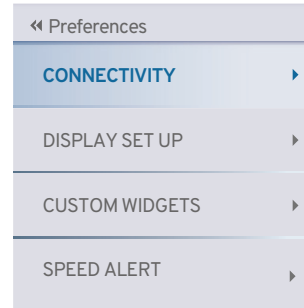

- ◆ CONNECTIVITY
- By press the 'SET' button on select the CONNECTIVITY option.
- There are 2 option available in the CONNECTIVITY.
 - ◆ PAIRED DEVICES
 - ◆ DISPLAY CALLS

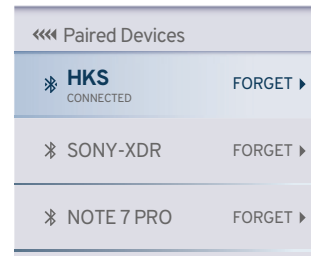
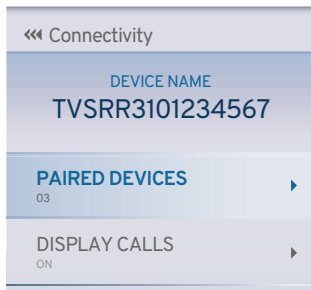

- It shows number of devices paired in the TFT instrument cluster.
- To remove the paired device from the TFT instrument cluster press the 'SET' button on the selected device name.
- Adding new device to vehicle **(ref.page no 98)**

- ◆ Paired Devices
- By press the 'SET' button on select the PAIRED DEVICES option.

- ◆ DISPLAY CALLS
- Press the down button to select the DISPLAY CALLS and press the 'SET' button to select the following function.

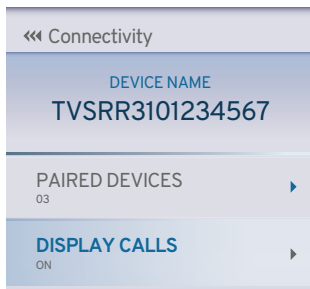

- Press the 'SET' button to ON or OFF to avoid the display calls visible in connected TFT instrument cluster.

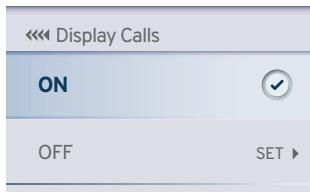

- If display calls setting is ON condition.
- The connected TFT instrument cluster will display the incoming calls alerts from the smart phone via Bluetooth. Ex. CALL FROM 'Arun Ramakrishnan', will be displayed if the contact is stored in the smart phone's otherwise number will be displayed.



- Press the 'SET' button to accept the incoming call. Press the 'RETURN' button to reject the incoming call (**ref. page 32**).

Note

Telephony features are disabled in TRACK mode for a safe ride.

Caution

To avoid risk of accident, and breach of Motor Vehicle Act & Rules, it is highly recommended not to respond to mobile call by operating the handle bar switches for accepting or rejecting the calls when the vehicle is in motion.

- ◆ DISPLAY SETUP
- Press the down button to select the DISPLAY SETUP and press the 'SET' button to select the following function.

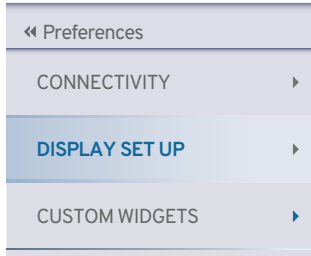

- There are 4 option available in the 'DISPLAY SETUP'.
 - BRIGHTNESS
 - CLOCK
 - DATE
 - DAY AND NIGHT MODE

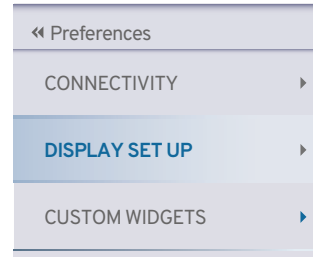

- ◆ BRIGHTNESS
- By press the 'SET' button on select the BRIGHTNESS option.

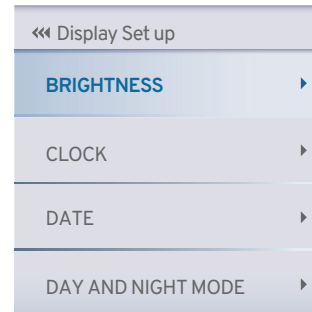

- BRIGHTNESS
- By press the 'SET' button on select the BRIGHTNESS option.

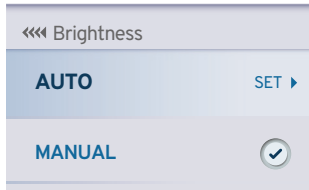

- By press the 'SET' button on select the AUTO option.
- Adjusts the TFT brightness and tell tale indicators brightness automatically as per day and night conditions (**ref. page 44**).

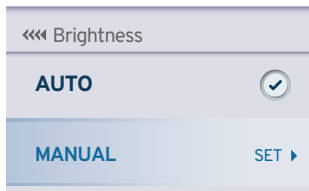

- Press the down button to select the MANUAL and press the 'SET' button to select the following function.
- Press the UP button to increase the brightness and the DOWN button to reduce the brightness of the cluster.

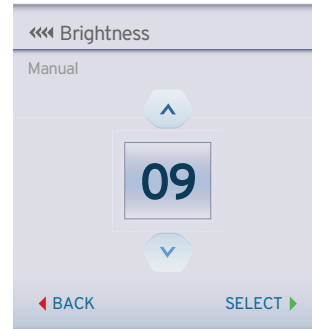

- Press the SET button after choosing the desired brightness level.

Note

The brightness ranges between 1 to 10 and can be set as per your preference.

◆ CLOCK

- Press the down button to select the CLOCK and press the 'SET' button to select the following function.

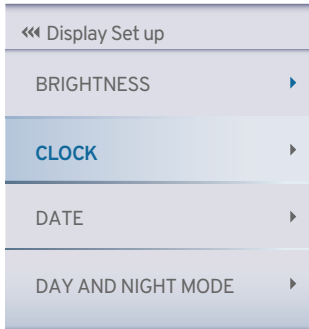

- The time displayed on the cluster will get auto-synced once the mobile is connected (**ref. page 47**).

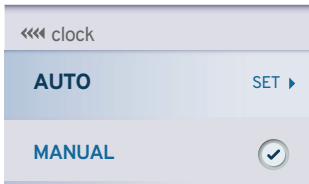

Note

The clock time gets sync automatically on pairing your Android and iOS smart phone with the connected TFT instrument cluster provided if auto sync clock setting is enabled in app.

- Press the down button to select the MANUAL and press the 'SET' button to select the following function.

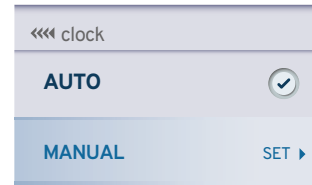

- In manual select the desired time format (12-hour or 24-hour) and press the 'SET' button.

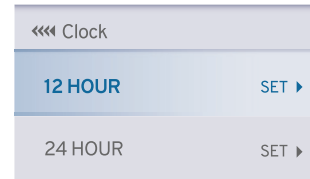

- For 12-hour press the UP button to increase the hour value and press the DOWN button to decrease the hour value.

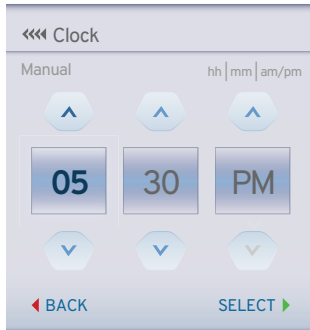

- Press the 'SET' button after setting the hour value and for proceeding to set the minute value.
- Similarly, for the minute setting, press the UP button to increase the minute value and the DOWN button to decrease the minute value.
- Press the 'SET' button after having set the correct minute value.

- Toggle between AM and PM using the UP and DOWN buttons and then press the 'SET' button.
- For 24 hours press the down button to select the 24 HOUR and press the 'SET' button to select the following function.

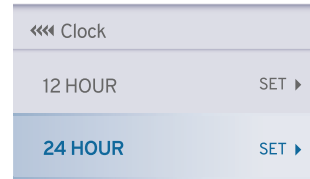

- Press the UP button to increase the hour value and press the DOWN button to decrease the hour value.
- Press the 'SET' button after setting the hour value and for proceeding to set the minute value.
- Similarly, for the minute setting, press the UP button to increase the minute value and the DOWN button to decrease the minute value.
- Then press the 'SET' button to save the set time in the chosen format.

- ◆ DATE
- Press the down button to select the DATE and press the 'SET' button to select the following function.

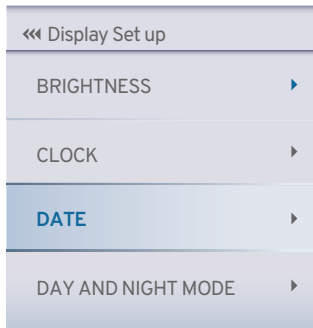

- The date displayed on the cluster will get auto-synced once the mobile is connected.

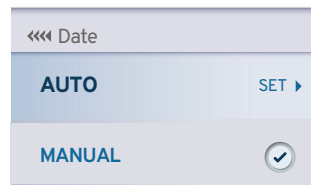

Note

The date gets sync automatically on paring your Android and iOS smart phone with the connected TFT instrument cluster provided if auto sync date setting is enabled in app.

- Press the down button to select the MANUAL and press the 'SET' button to select the following function.

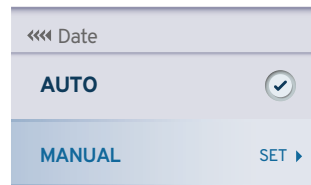

- Press the UP button to increase the date and the DOWN button to decrease the date.
- Similarly, using the UP and DOWN buttons, select the current month and year.
- Then press the 'SET' button to save the date.

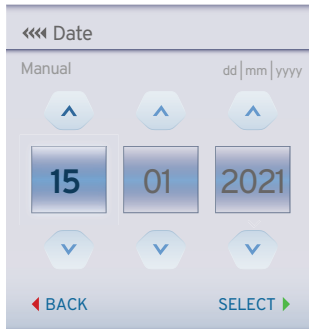

- ◆ DAY AND NIGHT MODE
- Press the down button to select the DAY AND NIGHT MODE and press the 'SET' button to select the following function.

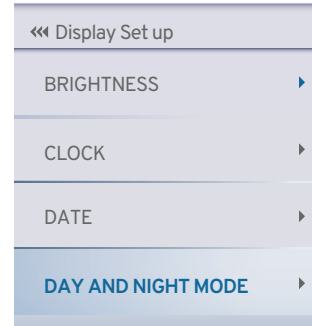

- In the connected TFT instrument cluster, with the help of photo sensor, the Day & Night mode themes will be changed automatically.

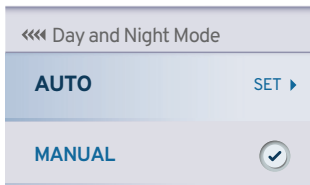

- Press the down button to select the MANUAL and press the 'SET' button to select the following function.

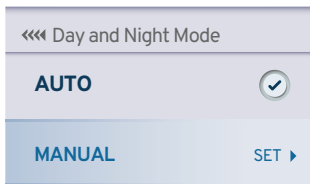

- In case you need to set the theme to Night mode, press the down button to select Night and then press 'SET' button to save the setting.

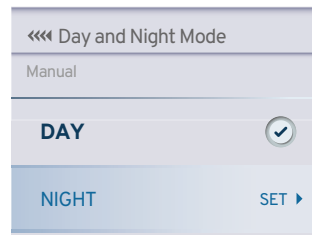

◆ CUSTOM WIDGETS

- Press the down button to select the CUSTOM WIDGETS and press the 'SET' button to select the following function.

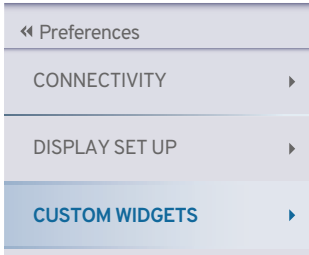

- Widgets (viz. ODO, IMI, Avg. Speed, Avg. Mileage etc.) can be used to display live feeds in the home screen of your connected TFT instrument cluster.
- From a list of below-mentioned 14 specified widgets, you can select any 4 for displaying on the widget screen:
 - Odometer
 - Top Speed
 - Avg. Mileage
 - Coolant Temp
 - 0-60 km/h

- IMI
- Lap TMR (lap timer)
- Range
- Avg. Speed
- Trip A Meter
- Trip B Meter
- Trip C Meter
- Day trip Meter
- Tyre pressure
- Press the up and down button to select the CUSTOM WIDGETS and press the 'SET' button to select.

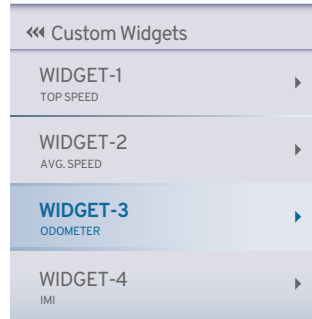

Note

For URBAN, RAIN and SPORT modes, you can select any 4 of the 14 widgets for being disclosed on the home screen.

On TRACK mode, you can select any 2 of the 14 widgets for being disclosed on the home screen.

- Odometer



ODO
99999.9 km

- ◆ (Odo meter) displays the total distance covered by the vehicle.
 - The reading is saved permanently and cannot be reset under any circumstances.
 - If the travelled distance exceeds 999999 km, the value '99999.9' will be displayed permanently.

- Top Speed

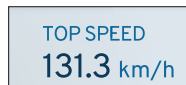

TOP SPEED
131.3 km/h

- Displays the top speed achieved by any user so far.
 - If the vehicle's current speed is greater than the recorded speed, the new value will get updated automatically.
 - User can reset and record a new speed data if required.
 - To reset the value (**ref. page 69**).

- Avg. Mileage

AVG. MILEAGE
31.3 km/l

- ◆ Indicates the average mileage (fuel economy) of the vehicle.
 - User can reset the value.
 - This value gets updated only after the vehicle speed increases more 10 km/h for the first time after ignition ON and continue to update till the engine switch OFF.
 - To reset the value **(ref. page 69)**.

- Coolant Temp

COOLANT TEMP
32.5 °C

- ◆ Coolant temperature indicator indicates the engine temperature in degree Celsius.
 - Take the vehicle to the TVS Motor Company Authorised Main Dealer for further diagnosis if this indicator starts flashing.

- Similarly, if the coolant temperature indicator 'H' shows more than six bars take the vehicle to



- ◆ the TVS Motor Company Authorised Main Dealer for further diagnosis.

Caution

In case of coolant temperature sensor fault or cooling fan fault or throttle position sensor fault, the vehicle will go to reduced performance mode (limp-home) in order to safe guard the bike from any damage and also to protect the rider.

- 0-60 km/h

0 - 60 km/h
3.82 s

- ◆ This function lets you to measure the time to reach 0 to 60 km/h speed from rest and to view the best time taken so far.

- If the current time is lesser than the stored value, the new value will get updated automatically.

-Toggle the display navigate to 'performance record' in menu to reset the value (ref. page 69).

- IMI

IMI
31.3 km/l

- ◆ Indicates the instantaneous mileage (fuel economy) of the vehicle at that particular driving condition.

-The value will not be shown if the vehicle speed is less than 10 km/h.

- Lap Timer

LAP TMR (mm:ss.ms)
39:00.11

- Press the pass-by switch for about 2 seconds to trigger lap counter. The lap timer widget will show the current lap time.
- To end the current lap and start new lap, press the pass-by switch again.
- To stop the lap counter, long press the pass-by switch for more than 2.5 seconds. The lap timer widget then shows the last lap time.
- This widget displays the current lap time and once the current lap is stopped then the last recorded time will be displayed.
- Each lap must have a minimum duration of 10 seconds.
- The connected TFT instrument cluster can store a maximum of 10 laps along with the date and time when the lap was triggered.

- 'Best lap' duration is shown based on the 10 lap durations stored and displayed in the menu under PERFORMANCE RECORD.

««« Laps (mm:ss.ms)	
BEST LAP 29:12.32	
LAPS Showing 1-4 of 10	
1) 30:34.22	22/06/2018 - 06:33PM
2) 31:34.22	22/06/2018 - 06:33PM
3) 29:34.22	22/06/2018 - 06:33PM
4) 29:12.32	22/06/2018 - 06:33PM
RESET ▶	

- To reset the value (**ref. page 70**).

Note

After 10th Lap if the 11th lap is triggered then the values will be updated inside the LAP Menu on first in first out basis. This means 10th value in the LAP menu will show the latest data always.

If a particular lap time reaches 99 minutes, the current lap gets reset to 0.

The 'lap' function is disabled automatically if the 'ignition lock' or 'switch engine cut off' is turned OFF while it is active and the current lap time will not get stored even though the lap timer had been active before the turning OFF the 'lock / switch'.

If the lap timer function is switched ON when only fewer laps have been completed earlier (eg. 4 laps completed), it starts from the next lap only (5th lap) and not from the first.

In the lap timer, complete stored laps can be reset.

◆ Range

FUEL RANGE
150 km

- ◆ Indicates the approximate distance that can be covered by the vehicle with the available fuel in the tank.

Note

The 'Range' reading may not be accurate when the vehicles is propped on side stand and should be calculated only when the side stand is folded.

- Avg. Speed

AVG. SPEED
86 km/h

- ◆ Displays the average speed of the vehicle based on total distance covered since last reset / by the total time when the engine rpm is greater than 500 rpm.
-To reset the value (**ref. page 69**).

- Trip A, Trip B, & Trip C & Day trip meter

TRIP A METER
45.5 km

TRIP B METER
55.6 km

TRIP C METER
31.3 km

- ◆ Trip meter displays the trip distance travelled in kilometer since last reset.
 - Three trip meters (Trip A, B & C) with the range upto 9999.9 km is provided to measure different trips.
 - The trip distance will be initialized to '0 km' automatically once reached 9999.9 km.
 - To reset the value (**ref. page 64**).

Note

Trip details such as distance covered, time travelled, average speed, top speed, fuel consumed and average mileage are recorded by the trip details for individual journeys.

- Day trip meter
- Day trip meter displays the trip distance travelled in that particular day.

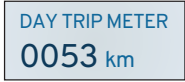

- Tyre pressure
- Indicates the tyre pressure of both front and rear wheel of the vehicle.



- There are four warning levels that will be displayed based on the pressure levels of the tyres. They are:

- If the tyre pressure is very low (= 20 PSI), the notification 'VERY LOW TYRE PRESSURE' will be displayed and the pressure values of widget starts blinking in red colour.
- If the tyre pressure is low (22 PSI) the notification 'LOW TYRE PRESSURE' will be displayed and the pressure values of widget changes from green to red colour.
- If the tyre pressure is high (38 PSI) the notification 'HIGH TYRE PRESSURE' will be displayed and the pressure values of widget changes from green to red colour.
- If the tyre pressure is very high (42 PSI) the notification 'VERY HIGH TYRE PRESSURE' will be displayed and the pressure values of widget starts blinking in red colour.

Note

Tyre pressure monitoring sensor (TPMS) is fitted in the tyres to measure and indicate the tyre pressure value. If the TPMS is replaced by any chance, it should be configured to the instrument cluster of your vehicle to get the tyre pressure indication. Contact any of our Authorised Premium Bike Dealers for doing the needful.

- ◆ SPEED ALERT
- Press the down button to select the SPEED ALERT and press the 'SET' button to set over speed indication.

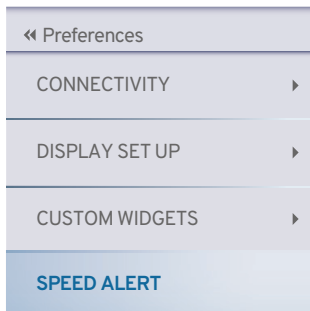

- Press the UP button to increase the over speed indication and the DOWN button to reduce the over speed indication.

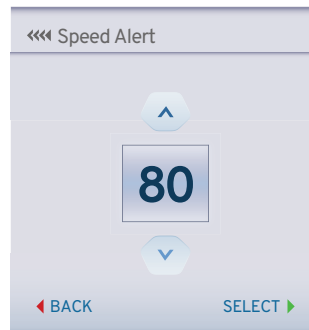

Note

The default speed alert will be set as 60 kmph.

The over speed indication can be set between 50 to 160 kmph in intervals of 10 kmph.

- Speed Alert in red band on status bar and red boundary box around the speed digit will appear and blink as soon as the speed exceeds the set limit.
- Red band & red boundary box will be displayed for 10 seconds.
- If the speed remains more than the set limit even after 10 seconds, the red colored boundary box will blink around the speed digits.



◆ TRACTION CONTROL

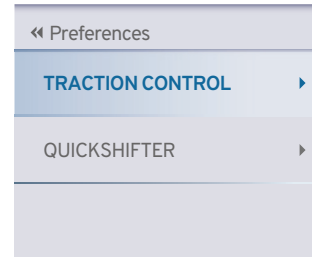

- Traction control feature will prevent loss of traction while accelerating the vehicle. It controls the engine torque and stabilizes the vehicle when the throttle input and subsequently the torque transferred causes slip to the rear wheel especially in low friction road surface conditions.
- Traction control feature can be turned 'ON' or 'OFF' through connected instrument TFT cluster.

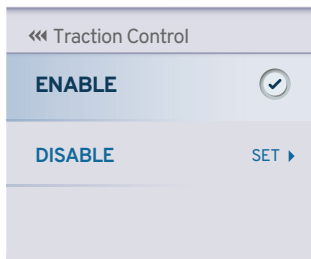

Note

By default, traction control will be 'ENABLE'. In each ignition "ON" cycle. For your safe rides, it is not advisable to switch 'DISABLE' traction control.

- After entering the 'Preferences' menu, select the 'Traction Control' option using 'Up' (D2) or 'Down' (D3) arrow.
- Once the 'Traction Control' option is selected, press the 'ENT' (D1) button.
- Press the 'ENT' button to set the 'ON' or 'OFF' the traction control.

Key functions of Traction control

- Control engine torque and ensure optimal driving force on the road.
- Prevent the rear wheel from spinning during acceleration, and counteract the front wheel from leaving the ground.
- Regulate the maximum engine torque, when the rear wheel spins during vigorous acceleration.
- Best acceleration with keeping stability by proper wheel longitudinal slip control at rear.
- Mitigation for uncontrollable large Wheelie by engine torque down.

- ◆ QUICKSHIFTER
- Quickshifter feature will assist while shift the gear refer **page 36** for details.

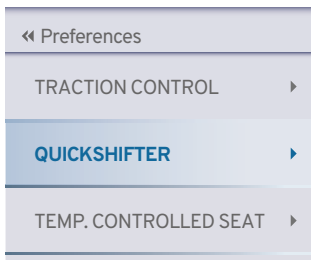

- Quickshifter feature can be turned 'ON' or 'OFF' through connected instrument TFT cluster.
 - After entering the 'Preferences' menu, select the 'Quickshifter' option using 'Up' (D2) or 'Down' (D3) arrow.
 - Once the 'Quickshifter' option is selected, press the 'ENT' (D1) button.

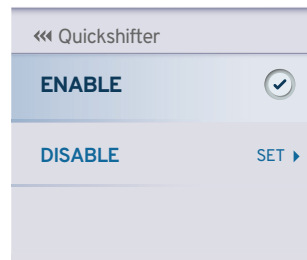

- Press the 'ENT' button to set the 'On' or 'Off' the quickshifter feature.

Note

By default, the quick shifter is always ON every time the ignition is turned 'ON'.

TVS CONNECT APP



Dedicated smart phone app is available in the Google Play and the Apple store for your 'TVS RR310' and it can be installed in your Android and Apple smart phones. To access the features of your TVS RR310's connected TFT instrument cluster like :

- Incoming call alerts in connected instrument cluster.
- Battery status of your smart phone in connected instrument cluster.
- "Do Not Disturb" mode during the ride (applicable only for Android smart phones).
- To send navigational assist instructions inputs to the connected instrument cluster from your smart phone.
- To store Digital documents such as Driving license, RC copy, Aadhar card etc. in TVS Connect App and transfer same in instrument cluster
- To save the last traveled route.
- To locate the last parked location of your TVS RR310.
- To know the signal strength of your mobile network in connected instrument cluster.

- To generate and store Ride reports.
- To sync the connected instrument cluster clock with smart phone clock.
- Try to avoid use the navigation feature while riding as a safety measure.

This dedicated mobile app of your TVS RR310's can be downloaded from the Google Play and the AppStore® by searching the key word 'TVS CONNECT' else by scanning the below QR code.



Android



IOS



Caution

While using the navigation feature, ensure you do not look at the speedometer for long as it might lead to an accident.

Note

This smart phone app is compatible only for the smart phones with Android OS version 8 and above, iOS version 11 and above and the BLUETOOTH version 4.0 and above. Android and Google Play are trademarks of Google LLC. App Store® and iOS are trademark of Apple.

If any issues with connectivity features please approach TVS Motor Company Authorised Main Dealer

How to login

On opening the **TVS CONNECT** app for the first time you have to login using your mobile number. Then enter the OTP which is received from TVS Motor Company Limited.

Login

+91 | Mobile Number

Use your registered mobile number

Verify OTP

OTP has been sent to +91 *****3210

Please enter your OTP

□ □ □ □ □ □

Didn't get the OTP? 1:56

On submitting the OTP. You need to agree to terms of service and privacy policy and click agree and continue. Now click onboard a TVS Vehicle.

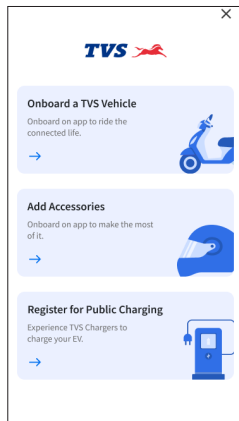
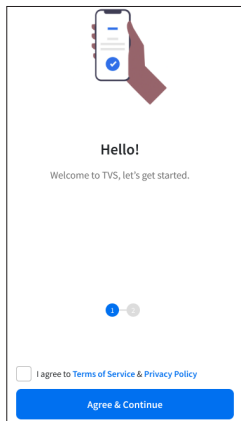

Select your vehicle that need to be linked to your App. If no vehicle linked with your mobile number. A vehicle can be added using VIN / chassis number, of the vehicle.

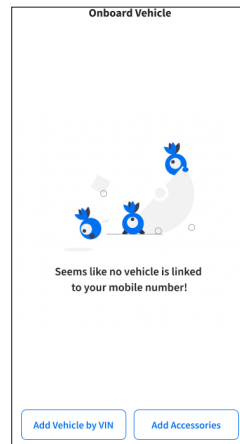
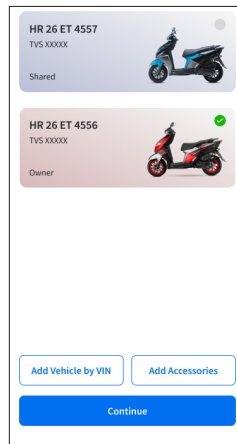

After successful verification of your chassis number, the Home screen of the app opens.

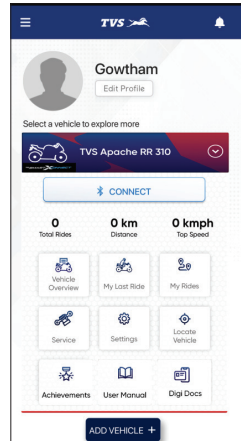
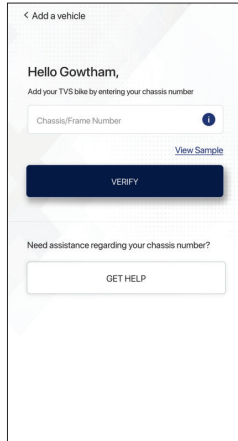

Note

Please remember that the navigation license has to be renewed after 5 years of vehicle purchase and renewal can be done by contacting near by TVS Motor Company Authorised Main Dealer.

First time Bluetooth pairing:

To pair your Android smart phone or iPhone with your TVS RR310's connected instrument cluster, via Bluetooth, for the first time.

- In order to pair device, select "preferences" in 'menu' by navigating to connectivity paired device.

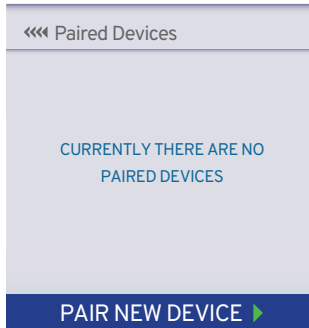

- Press down button and press the set button to pair a new device.
- Once a device is selected the new paired device icon will blink.

- Ensure that switch ON bluetooth in your mobile device
- During the pairing, the bluetooth symbol 'flashes' in the connected TFT instrument cluster.
- Open the **TVS Connect** app and press "CONNECT"; ensure the smart phone is near to the vehicle.



- Press and hold "CONNECT" for 2 sec to erase previous vehicle details and connect with a new vehicle in the TVS connect app.

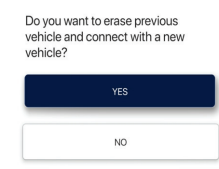

- In connected TFT instrument cluster Bluetooth name is prefixed by TVSRR310 and followed by alphanumeric digits. Ex : 'TVSRR3100000000'.
- Now, select the 'TVSRR3100000000' in app to initiate the pairing process.

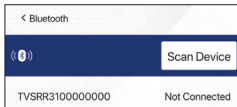

- Passkey will be display in the Connected TFT instrument cluster as shown.

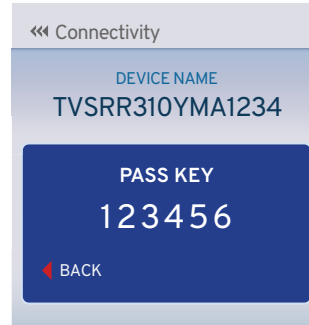

- Now, enter pass key '123456' in app to initiate the pairing process.

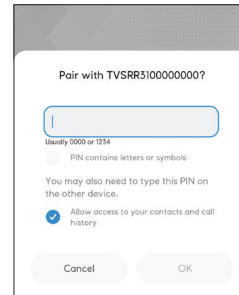

- On pairing, connected TFT instrument cluster displays 'CONNECTION SUCCESSFUL' message is display.

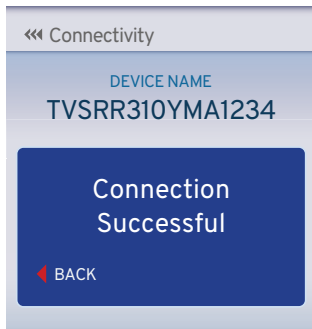

- Once device paired the Bluetooth '📶' icon phone's battery '🔋' icon and signal strength '📶' icons will be displayed on connected TFT instrument cluster.



Note

During the course of pairing process, if there is any occurrence of error, the connected instrument cluster should be turned 'OFF' and 'ON', and the application also need to be restarted.

Please remember that, all the smart phones are not compatible for pairing with the TVS RR310's connected TFT instrument cluster.

During the search of Bluetooth devices in app, if the vehicle connected instrument cluster's Bluetooth device ID is not visible, try for one or two more iterations.

In your motorcycle only five devices can be added. To add a 6th device, delete any one paired device and try pairing a new device.

Note

Only one iPhone can be auto-paired with a single instrument cluster at a time. If the user need to connect multiple iPhones with the single instrument cluster, the previous connected iPhone has to be forgotten by clicking, "Forget This Device" from Bluetooth settings in the iPhone.

If the vehicle battery is reset or fuse is blown, then too "Forget This Device" from Bluetooth settings in the iPhone has to be done.

Steps to "Forget This Device" in iPhone:

If the user needs to connect multiple iPhones with the single instrument cluster, the previous iPhone has to be forgotten using "Forget This Device" from Bluetooth settings in the following manner:

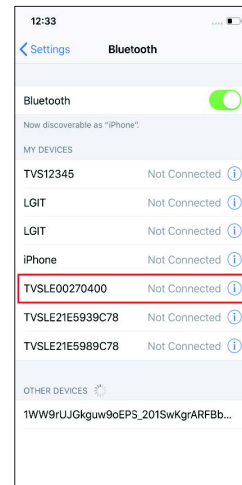
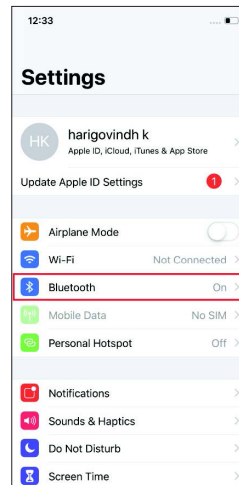

1. In the previous connected iPhone, open the SETTINGS -> BLUETOOTH.
2. Select the instrument cluster, which was connected previously.
3. Click on the "Forget this device".

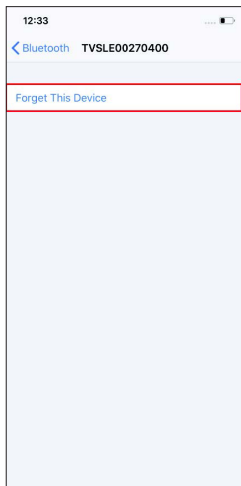

Auto pairing

Once the first time pairing is done between vehicle's connected TFT instrument cluster and your smart phone, the phone will automatically pair with the vehicle when the following conditions are met :

1. Auto connect will happen after pairing only if app is opened in the mobile and connect button is pressed on the App.
2. If the ride is on going and the rider does ignition lock OFF and then ignition lock ON, then app gets auto connected and ride will continue on App until user ends the ride.
3. Once the rider ends the ride, to start a new ride he has to press connect button in the app.



Caution

In certain Android phones auto pair functionality does not work after first time pairing due to compatibility with various OS versions.

 **Note**

If the phone enters battery saver mode, auto-pairing might not happen. It takes maximum of five minutes for auto-pairing and it can happen in vehicle running or engine at idling or engine off condition.

Auto-pairing happens only if the application is locked in the RAM in multitasking screen of the phone with manufacture's customized OS (Ex : MI, Vivo etc.)

In case of Android phones with Android OS version above 8.0, for App to work seamlessly, any battery optimization setting to be removed in the TVS Connect App and GPS shall be allowed to run in background in high accuracy mode.

Even if your phone's Bluetooth is already paired to other gadgets like smart watch, health band or helmet, the auto-pairing works with your TVS RR310 's connected instrument cluster.

If the application unfortunately stops due to unforeseen circumstances, close and reopen the application and do the manual pairing for the first time, then auto pairing will happen subsequently.

 **Note**

Once the connected instrument cluster of your TVS RR310 is connected with your smart phone, the connected instrument cluster displays Bluetooth '⌘' icon, your mobiles battery level '🔋' icon and network providers signal strength '📶' icon.

Incase multiple SIM cards are used in smart phone, by default, SIM 1's network provider's signal strength is shown in the display of connected instrument cluster.

Signal strength displayed in connected instrument cluster might vary from the display in smart phone as the former is referred from telephonic standards.

Digi Docs

Digi Docs is used to transfer the images or documents such as driving license, RC book, Aadhar card etc. from the TVS Connect app to TFT Instrument cluster using both Android and iOS mobile phones. Follow the below steps to upload the image from gallery or camera to the TVS Connect app.

- Open TVS Connect app.
- Click Digi Docs icon.



- Clicks LET'S GO icon.
- Select image from gallery or camera.

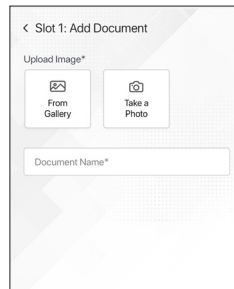
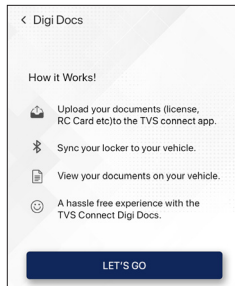

- After selecting the documents, press 'Sync locker to vehicle' button to connect TVS Connect app and start document transfer

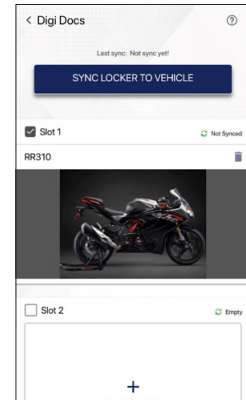
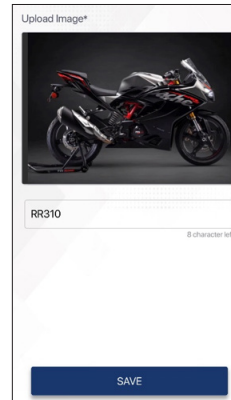

Now the image is ready to transfer to TFT Instrument cluster. Once the TVS Connect app is connected to TFT Instrument cluster the synchronization starts automatically.

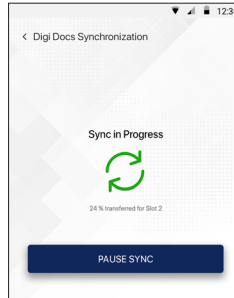
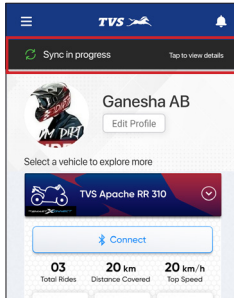

The synchronization can be paused by clicking 'PAUSE SYNC'.

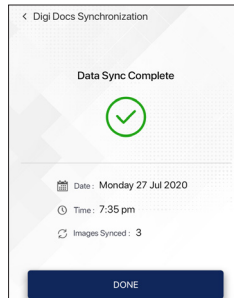
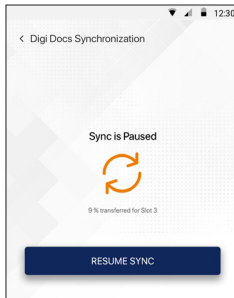

Synchronization can be resumed by clicking 'RESUME SYNC'.

Note

Total of 3 documents can be stored in the TFT Instrument cluster. (ref. page 71).

Time to transfer one image without loss of data around 12 minutes.

Voice Assist:

The connected functionality of your TVS Apache RR 310 comes with an additional feature – Voice assistant.

With the help of the voice assist feature, you will be able to access the mobile application and instrument cluster through speech. Once the mobile application connected to the instrument cluster, voice assist feature can be used.

There are two ways to invoke the voice assist feature of your vehicle:

- By pressing the 'Down' button of the control switches (**ref. Fig. 24**) for more than 3 secs when the notification area of the cluster is displaying customer window.
- By pressing the voice assist icon in the app's live dashboard.
 - After invoking voice assist either of the two ways, 'Listening' will appear on the screen and a 'speak now' voice will be heard on the headset.

Note

Voice assist will work with screen lock condition / app background condition (depending on smart phone's OS restrictions).

Use wired / wireless earphones for listening and talking.

Voice feedback will work only if a wired / wireless headphone is connected.

Option to enable / disable voice assistant and voice feedback is available in app settings.

Wait for a second and start speaking / providing the command once you hear 'speak now' voice on the headset.

Voice commands:

The following are the list of intents recognized by voice assist. You can refer the below table for sample commands of each intent:

Sl.No.	Intents	Voice commands inputs
1	Listening	NA
2	Processing the input	NA
3	Greetings	Hi buddie How are you doing Hi buddy Hello friend How u doing
4	Navigation (default one)	Go to Take me to Let's go to Navigate to Navigate me to Guide me to Show me Take to Directions to Show me directions to

SI.No.	Intents	Voice commands inputs
5	Current location (default one)	My location Where are we right now What is the name of this place Where am i now What is my current location Show my location Show my current location Show current location Show location Where am I Where are we right now
6	POI	Near Near by Near to Nearest
7	Call last	Last call Who called me last Who called recently Last caller Show my last caller Who is my last caller



SI.No.	Intents	Voice commands inputs
8	Volume increase	Increase volume Volume up Increase sound
9	Volume decrease	Decrease volume Volume down Decrease sound Reduce volume
10	Setting DND enable	Enable do not disturb
11	Setting DND disable	Disable do not disturb
12	Setting high speed alert enable	Enable high speed alert
13	Setting high speed alert disable	Disable high speed alert
14	Setting auto sms enable	Auto sms enable
15	Setting auto sms disable	Auto sms disable
16	Cancel navigation	End / cancel navigation
17	Top speed	Show my top speed

SI.No.	Intents	Voice commands inputs
18	Ride start time	When did I start my ride What time I start ride Ride start time Show start time Show ride start time Start time of ride

Things to do while using voice assist:

- We recommended to use ANC (Active noise cancelling) Bluetooth devices for better performance.
- Ensure microphone is kept near to your mouth while giving out commands.
- Please ensure that it is not exposed to outside environmental noise such as wind noise, other vehicle noise etc.
- We recommend you go through the sample command list before trying your intent.

Things not to do while using voice assist:

- We recommend you not to use the method of invoking voice assist through mobile app while riding.
- Please do not use voice assist functionality during heavy traffic conditions.

Voice feedbacks:

- TVS Apache RR 310 also has feature of voice feedbacks along with voice assist functionality.
- Voice feedback feature communicates from vehicle to you of either critical parameters like fuel level or rider warning like direction indicator and side stand alert chimes. Some of the features in voice feedback like turn on mobile data will work only in voice assist mode as shown below:

SI.No.	Voice feedbacks	Voice feedback heard in headphones	Cluster display
1	Bluetooth connected every time	Hello " _____"; how can I help you?	Icon already there with message of BLE successful
2	Phone battery low	Phone battery low	Icon already present
3	Side stand ON	Chimes sound	Icon already present
4	Low fuel	Fuel level warning, please refill	Messages already present 'Low fuel'
5	High engine temperature		Messages already present in top notification bar. 'High engine temperature'
6	Long trip duration	Break time	Long trip duration message on top notification bar
7	Service due		Service due
8	Poor network		Poor network
9	Turn signal indicator ON		Chimes sounds are heard

Note

This section shows the position and operation of the major components of your motorcycle.

Major Components (ref. Fig. 23)

- 1) Cooling system (radiator) (ref. page 114)
- 2) Fuel tank cap (ref. page 116)
- 3) Seat lock (ref. page 119)
- 4) Adjustable rear shock absorber (ref. page 131)
- 5) Coolant reservoir (ref. page 114)
- 6) Rear view mirrors (ref. page 129)



* Hidden items are marked with dotted lines

Fig. 23

Cooling System (Radiator) (ref. Fig. 24)

A coolant is used in the motorcycle cools the hot engine and ensures that operating the vehicle at specified temperature which in-turn avoids the risk of malfunctions.

- A radiator and cooling fan fitted in the cooling system does job of cooling the coolant used in the motorcycle by air stream.
- Dirty cooling foils of radiator reduces the cooling effect. Do the visual check and ensure the cooling foils of the radiator are not clogged with any dirt or mud. If so contact TVS Motor Company Authorised Main Dealer.

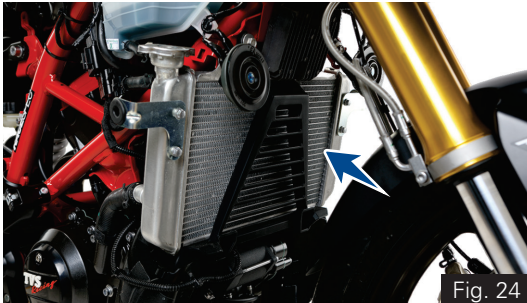

A coolant reservoir tank (A) is fitted on the right side of the motorcycle below the side panels (ref. Fig. 25).

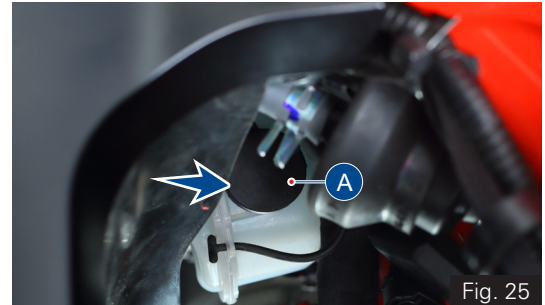

Note

The cooling fan may switch ON approx 22 secs. after the ignition is turned OFF to reduce the heat and to protect the engine which is normal. Need not panic.

- Visually inspect the coolant level in the tank (use a torch if required).
- The coolant level should be between minimum and maximum level (1 & 2) on the tank (ref. Fig. 26).

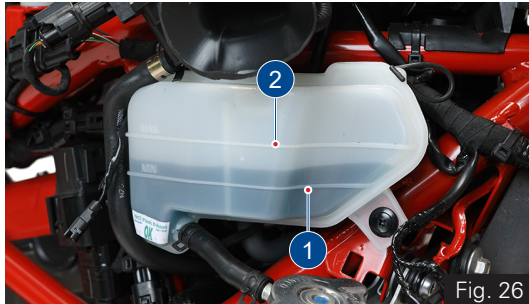

Fig. 26

- Contact TVS Motor Company Authorised Main Dealer for topping-up if the level in the tank is lower than the minimum level.

Warning

Coolant is poisonous and health hazard. Avoid contact between coolant and body or clothing incase if you are handling it.

Caution

Use only recommended coolant (Glycentine G48, Coolant + Water; @ 50:50 ratio; total filling 1 litre). Use of improper coolant may cause damage, such as corrosion in the engine parts, blockage of the cooling passage or radiator and premature wear of the water pump seal.

Do not use tap water, or mineral water while topping-up the coolant.

Fuel Tank Cap (ref. Fig. 27)

This motorcycle is equipped with a lockable fuel tank cap (A).

To open:

- Lift the protection lid (B).
- Insert the control key into the lock. Rotate the key a 1/4 turn clockwise and lift the cap.

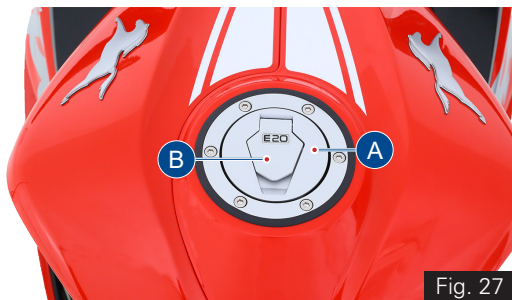

Fig. 27

To close:

- Push the cap down into its seat until hearing a click sound.
- Turn the key anticlockwise to the initial position and remove it.
- Close the protection lid.

Refueling (ref. Fig. 28)

- Never overfill the tank when refueling. The fuel level always be below the brim of the fuel tank neck (A).

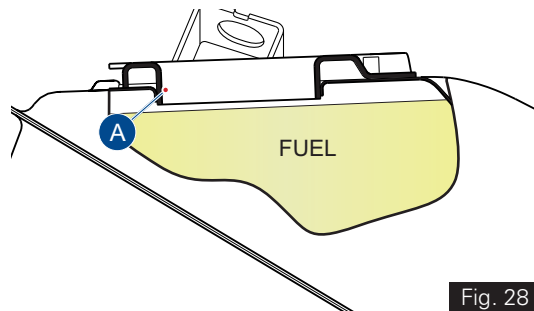

Fig. 28

** The fuel tank is not a measuring instrument and the capacity of the fuel tank may slightly vary from the indicated capacity.*

 **Warning**

Do not smoke while refueling. Do not use cell phones while refueling.

Avoid spilling of fuel on hot engine. Refill petrol in well ventilated area.

Switch OFF the engine and ignition key while refueling as petrol is highly inflammable. Be sure there is no fuel trapped in the filler recess.

To avoid evaporation of petrol and deterioration of paint gloss due to ultra violet rays and heat of sunlight, always park your motorcycle in a covered parking.

Avoid using mobile phones for navigation while fueling.

 **Caution**

Check for abnormal jerk / noise while opening the cap / leak. If found any, contact TVS Motor Company Authorised Main Dealer.

 **Note**

After ignition ON, the instrument cluster checks for multiple parameters. Side stand status is one of such parameters. If the side stand is engaged, then the fuel level indication indicates the previously stored value. Once the side stand is dis-engaged, the fuel level display gets updated if there is any change in the volume.

Always make sure to close the cap properly after every refilling to avoid leak / evaporation.

Side Stand (ref. Fig. 29)

Side stand (A) can be operated with your foot. To support your motorcycle on side stand:

- Hold the motorcycle handle bars with both the hands and push down the stand with your foot until the stand is fully extended.
- Lean the motorcycle to the left until the stand contact the ground.
- To move back the side stand to its original position (horizontal position), tilt the motorcycle to the right and, at the same time, lift the stand with your foot.

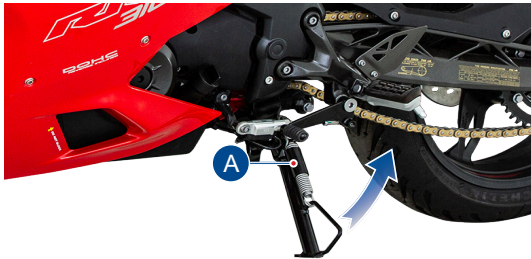

Fig. 29

Caution

Before supporting the motorcycle on side stand, make sure that the supporting surface is hard and flat. Do not park the motorcycle on soft ground, gravel etc., else the bike may fall down.

While parking the motorcycle in downhill tracks, always park the bike in such a way that the rear wheel of the bike facing downhill.

Ensure not to disturb the side stand switch setting.

Warning

Do not sit on the motorcycle when it is supported on side stand.

Seat Lock (Rider and Pillion Seat)

This motorcycle is equipped with a lockable rider and pillion seats. The seat lock (A) is located between the rider and pillion seat as shown (ref. Fig. 30)



Fig. 30

To open pillion seat:

- Insert the control key into the seat lock. Rotate the key in clockwise until the lock is released.
- First, slide the seat towards vehicle front direction.
- Ensure the hook underneath got released from frame and take out the seat.

To close pillion seat:

- Slide the rear end of the seat bottom underneath the frame hook.
- Locate the seat lock pin into seat lock latch and gently press (at the front end).
- Finally ensure that the seat is fastened securely to the frame.

To open the rider seat:

- Remove the pillion seat as explained earlier and take out the control key from the seat lock without fail.
- Take off the tool kit from the storage (ref. Fig. 31)



Fig. 31

- Pull the seat release cable (A) to release the seat lock (ref. Fig. 32).
- Keeping seat release cable pulled, lift the seat from rear and slide it backward.

To close the rider seat:

- Slide the front end of the seat bottom underneath the frame hook.
- Locate the lock pin of the seat into seat lock latch and gently press at the rear end.
 - Finally ensure that the seat is fastened securely to the frame.

 **Caution**

Take the control key out from the seat lock without fail during the removal of rider seat, to avoid damage to the seat / lock.

Make sure that the seats are locked securely in position after reassembly.

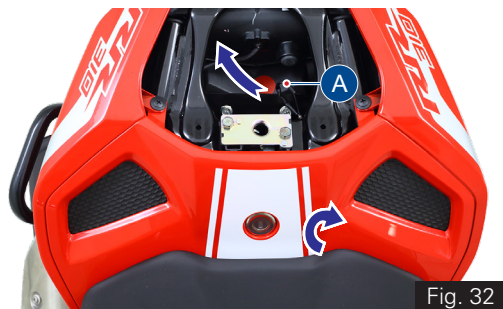

Fig. 32

Caution

Running-in is essential to preserve engine life and performance over time. Keeping to the running-in recommendations will ensure longer engine life and reduce the need for overhauls and re-tuning. Refer page 01 for running-in information.

Before Riding

- Ensure that tyre pressure is as per specification. Lower or higher tyre pressures are likely to cause instabilities in motorcycle behavior.



- Check operation of throttle, clutch, and brakes as well as free play on front and rear brakes. Pump in the brake lever and pedal a few times to ensure proper bleeding.



- Check both tyres for any wear or abnormalities. Ensure that wear is not below 'Tread wear indicator' mark.



- Check steering freeness, front and rear wheel freeness and alignment.



- Check tightening of wheel axle nuts, swing arm nut and steering nut.



- Also check tightening of front fork and shock absorber mounts.



- Check for chain slackness as per specification.



- Adjust mirror position to have optimum rear visibility. If you prefer track riding sans rear view mirrors, please remove and preserve them carefully.



Warning

Failure to carry out these checks before riding may result in damage to the motorcycle and injury to the rider.

- Check engine oil, brake oil and coolant oil levels.



While Riding

- Wear all necessary safety gears (Helmet, Jacket, Knee guards, Shoes and Gloves) before riding.



- Riding Posture - While riding, sit slightly behind the fuel tank. Body position should be relaxed such that back is very comfortable. Shoulders and arms should also be relaxed with slight bend in the arm as shown. Hold the handle bar with a good grip. Fuel tank should be firmly held by the thighs while riding. This will help maintain stability of the bike at all speeds.



- While riding, have a relaxed posture with wide vision.
- Ensure smooth operation of throttle, do not abruptly open the throttle especially in the corners
- Don't throttle while entering a turn. You may accelerate progressively while exiting a turn.
- Do not shift gears in a turn.

- Avoid abrupt hard braking, If hard braking is inevitable, release throttle and apply front and rear brakes in a progressive manner.
- Don't brake too hard while the vehicle is leaning, as vehicle may skid easily.
- Tyre grip reduces in cold conditions. It will take about 5 kms of riding for tyres to reach optimal temperatures.
- New tyres require running in for 20 kms before you can get the maximum grip.

Starting the Engine

- Turn-on the ignition key (ref. page 23). Ensure that the neutral indicator 'N' (C4, **ref. page 44**) is ON.
- Check that the engine cut-off switch is positioned at run mode '

Warning

Before starting the engine, familiarise your self with the controls which you need to use while riding (ref. page 23).

Note

It is possible to start the vehicle with the side stand ON and gear box in neutral. When starting the bike with the gear engaged, apply the clutch (the side stand must be up in this case).

If the battery voltage is too low, the system automatically disables the self-start function.

Caution

Do not rev the engine when it is cold. Allow some time for the oil to warm up and to reach all points that needs lubrication.

Moving the Vehicle

- Disengage the clutch by pressing the control lever.
- Press the gear shift pedal downwards with the tip of your foot to engage the first gear.
- Increase the engine speed by turning the throttle twist grip while gradually releasing the clutch lever; the motor cycle start moving forward.
- Release the clutch lever and increase the engine speed (increase the throttle).
- To up shift the gear, close the throttle to slow down the engine speed, disengage the clutch, lift the gear shift pedal up and release the clutch lever.
 - To down shift the gear, proceed as follows: release the throttle twist grip, pull the clutch lever, increase the engine speed for a moment to allow the gears to synchronise, down shift the gear and release the clutch lever.
 - Use controls wisely and promptly: when riding uphill do not hesitate to down shift the gears as soon as the vehicle tends to slow down. This will avoid stressing the vehicle and the engine abnormally.



Caution

Avoid sudden acceleration, as this may lead to misfiring, improper engagement of transmission (snatching).

Do not pull the clutch lever longer than necessary after engaging the gear. Otherwise the friction plates in clutch may get overheat and wears out quickly.

Braking

- Slow down the speed in right time, shift down the gear to use the engine brake, then apply both the brakes.
- Pull the clutch lever before stopping the motorcycle to avoid sudden stoppage of engine.

Warning

Use both front and rear brake for effective braking.

When riding in the rain or on slippery surfaces, braking capacity is significantly reduced. Always use the brakes very gently and carefully when riding under these conditions.

When riding downhill, shift down to the lower gears to use engine as a brake.

Caution

Keeping the brake applied continuously causes the brake pads (friction materials) to overheat and reduces the braking effectiveness which is dangerous.

Stopping the motorcycle

- Reduce speed, close the throttle and down shift the gears. Bring the transmission to neutral position just before the vehicle stops.
- Apply the brakes and bring down the motorcycle to complete stop.
- Turn OFF the ignition.

Parking

- Stop the motorcycle. Place it on the side stand on a flat firm surface (**ref. page 118**).
- Turn the steering all the way to 'left' or 'right' and lock as explained in **page 23**. Take out the control key from the ignition lock.
- If the vehicle is parked in a garage or other indoor area, make sure that there is a proper ventilation and the motorcycle is not nearer to a source of heat.

Note

You may switch ON the hazard lamps if the vehicle is parked in hazardous location. Refer page 27 for hazard lamps function.

Warning

The engine and the exhaust system might be very hot even after switching OFF the engine. Care should be taken not to touch the exhaust system with any part of your body.

Park the vehicle in a place where the pedestrians or children are not likely to touch the hot surface. Do not park the vehicle near dry grass or any other flammable resources which might catch fire.

Using padlocks or other locks like brake disc locks, rear sprocket locks etc. to prevent the movement of the motorcycle is very dangerous and may affect the motorcycle operation and safety of the users.

Fuel Recommendation

Use only BSVI ES Gasoline.

BS VI petrol containing upto 20% of ethanol by volume can be used.

Higher ethanol content in petrol can lead to

- degrade plastic and rubber components of fuel system and vehicle parts
- cause corrosion damage to metal parts like fuel tank, etc.

- result in startability & drivability issues
- decrease fuel economy

Ethanol absorbs water very easily, resulting fuel separation. Extra care shall be taken to prevent moisture entry into fuel tank while filling ethanol blended petrol and water washing of vehicle.

Painted parts (viz. panels, covers) shall not come in contact with ethanol blended fuels.

Manufacturer is not responsible for any warranty issues that results from using ethanol blend in excess of 20% by volume in petrol.

In case of any abnormalities observed due to use of ethanol blended fuels, customers are advised to use a different fuel station / brand for standard E20 fuel or contact authorised service centres.

- **Refer page 116** for fuel filling procedure.

Caution

Never mix oil in the petrol. Always fill fuel from reputed and reliable fuel stations.

Note

Use fuel additives in petrol (as recommended by additive manufacturer) for low carbon deposition.

Checks and Tips for Better Fuel Economy

- Carry out the periodic maintenance checks as specified in this manual (**ref. page 141**).
 - Regular maintenance checks will save fuel while ensuring trouble-free, enjoyable and safe riding besides keeping the environment clean.
- A dirty defective spark plug leads to wastage of fuel due to incomplete combustion.
 - Replace the spark plug every 20000 km. Use recommended plug only.
- A dirty air cleaner element restricts airflow and reduces fuel economy.
 - Replace the air cleaner element every 10000 km.
- Increase in engine rpm during acceleration, without increase in road speed indicates the clutch slip. A slipping clutch causes high fuel consumption and engine overheating.
 - Adjust the clutch play as explained in **page 150** if the above malfunction is observed.
 - If the condition persists even after adjusting the clutch play contact TVS Motor Company Authorised Main Dealer.
- Dirty or less engine cum transmission oil increases the friction between various parts of the engine and reduces engine life, and increases the fuel economy.
 - Inspect the engine cum transmission oil level as explained in **page 148** and top-up if necessary.
 - Engine cum transmission oil should be replaced as per the maintenance schedule without fail.
 - Always use recommended engine oil only (**ref. page 194**).
- Low tyre pressure has adverse effects on the vehicle. The drag on the vehicle increases resulting in decreased fuel economy. Further more handling may be affected adversely.
 - Check tyre pressure regularly and inflate them to recommended pressure. (**ref. page 155**).
 - Never use tyre which are worn-out beyond the permissible limit.
- Check and ensure the drive chain slackness. Excess slackness lead to higher fuel consumption (**ref. page 159**).
- Check and ensure the free movement of wheels by rotating them to avoid wastage of fuel.

- A racing start from rest at full throttle will waste fuel and damage the engine. It is also creates potentially hazard traffic situation.
- Fuel is wasted whenever the rider suddenly accelerate or apply brake.
- While waiting for someone or stopping in signals for long time, if the engine is kept running at idle speed, leads to unnecessary wastage of fuel.
- Anticipate corners and slopes as well as the traffic conditions. Unnecessary and frequent braking reduces the fuel economy.

Rear View Mirrors LH & RH (ref. Fig. 33)

Adjustable rear view mirrors (LH & RH) are provided with your bike. These mirrors can be adjusted to your convenience by following the procedure given below:



- Move the rear view mirror stem (A) to the desired position (forward or backward).
- Tilt the mirror portion (B) till the clear vision is obtained (up or down).



Caution

Never try to adjust the mirror position by mirror portion (B) this could break the mirror.

Clutch Lever - Adjustment (ref. Fig. 34)

TVS Apache RR 310 comes with an adjustable clutch lever. There are four positions provided for you to adjust the lever to suit your palm size.

The lever can be adjusted by adjusting the position adjuster (A) provided in the lever itself. 'Position - 1' is the closest position of the lever to handle bar grip and 'Position - 4' is the farthest (**standard position of the clutch lever will be 2 & 3**).

To adjust the lever position, push the lever forward and rotate the position adjuster to any of the four positions by aligning the 'arrow mark' (B) on the lever to the number provided on the adjuster.

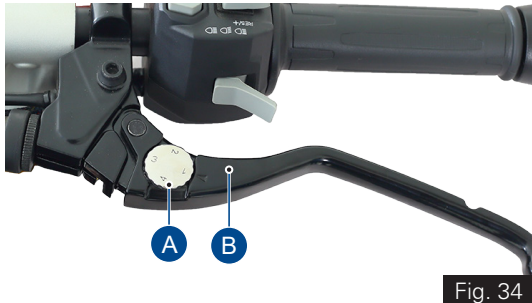

Fig. 34

Front Brake Lever - Adjustment (ref. Fig. 35)

TVS Apache RR 310 comes with an adjustable front brake lever. There are four positions provided for you to adjust the lever to suit your palm size.

The lever can be adjusted by adjusting the position adjuster (A) provided in the lever itself. 'Position - 1' is the closest position of the lever to handle bar grip and 'Position - 4' is the farthest (standard position of the front brake lever will be 2 & 3).

To adjust the lever position, push the lever forward and rotate the position adjuster to any of the four positions by aligning the 'arrow mark' (B) on the lever to the number provided on the adjuster.

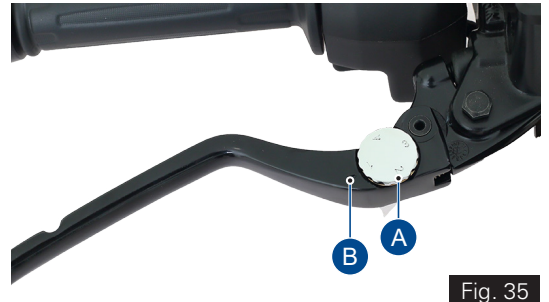

Fig. 35

ADJUSTABLE SUSPENSION*

Front fork adjustment

Note

Always set the spring loads in both fork legs equally, to obtain optimum suspension performance.

Each Fork leg is provided with a spring PRELOAD adjusting bolt, the right leg is provided with a COMPRESSION damping force and left leg is provided with REBOUND damping force, through damping adjuster screw.

Spring preload

Increasing the spring preload will harden the suspension. To decrease the spring preload, thereby soften the suspension. Turn the bolt as indicated in the Fig 36.



Fig. 36

The spring preload setting is determined by the distance A or no of groove, Shorter the distance A or no of groove indicates higher preload by rotating the preload adjusting bolt clockwise, higher the distance A or no of groove indicates lower preload rotating the preload adjusting bolt anti-clockwise.

* Applicable for Apache RR 310 BTO version

Compression damping force

The compression damping force adjustment is provided in the right leg only.

To increase the damping turn the adjuster screw clockwise and to reduce the damping turn the adjuster screw towards anti-clockwise, as shown. (ref. Fig. 38)

During adjustment count the numbers of clicks from fully closed (clockwise) position.



Fig. 38

* Applicable for Apache RR 310 BTO version

1st groove - hard suspension

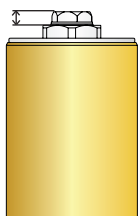

5th groove - Standard position

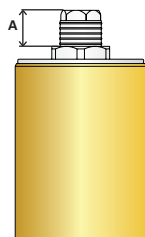

7th groove - soft suspension

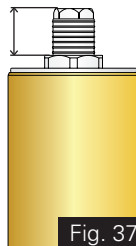

Fig. 37

Spring Preload	Distance 'A' (in mm)	Groove position
Standard	14	5
Maximum	4	1
Minimum	19	7

Caution

Do not attempt to over-tight the adjuster bolt, beyond the maximum and minimum position, to prevent internal damage.

Rebound damping force

The rebound damping force adjustment is provided in the left leg only.

To increase the damping turn the adjuster screw clockwise and to reduce the damping turn the adjuster screw towards anti-clockwise, as shown. (ref. Fig. 39)

During adjustment count the numbers of clicks from fully closed (clockwise) position.



Fig. 39

Note

When Adjusting the damping force setting turn the adjuster screw in clockwise direction until it stops, noting that the first click counted as 1 then count the clicks turning in anti-clockwise direction.

Although the damping adjuster may turn beyond the stated minimum settings, such turns are ineffective and advised not to turn further, as it may lead to the damage of damping mechanism.

Rear shock absorber's adjustment (ref. Fig. 40)

The pre-load of rear shock absorber can be adjusted as per rider's convenience and the load (weight of rider, passenger and luggage) on the vehicle.

There are 10 notches (1) for adjusting the pre-load of the shock absorber. Normally, the shock absorber's pre-load adjuster (2) will be positioned at 3rd notch (standard setting).

Increase the spring pre-load (shift to higher notches) for heavier rides.

Decrease the spring pre-load (shift to lower notches) for lighter rides.

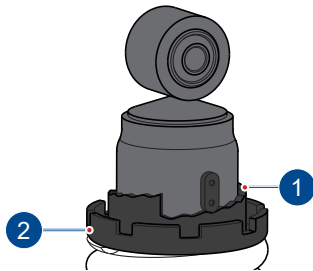

Fig. 40

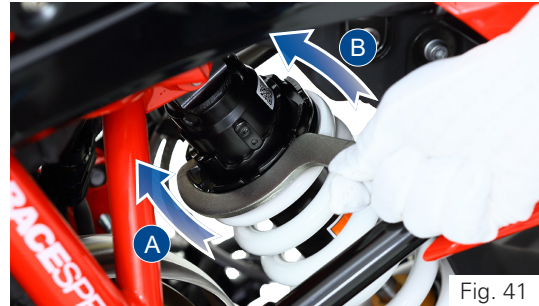

Fig. 41

To adjust the shock absorber's pre-load:

- Place the motorcycle on its stand on a firm and flat surface.
- Locate the adjuster shock absorber rear and handle ring spanner of tool kit (**ref. page 180**) properly into the notches of pre-load adjuster (ref. Fig. 41).
- Carefully rotate the adjuster clockwise (A) to increase the pre-load (hard suspension).
- Else, rotate the adjuster in anti-clockwise (B) to decrease the pre-load (soft suspension).

Warning

The rear shock absorber contains highly compressed gas. Do not try to open or disassemble it in any way.

Take a special care while turning the pre-load adjuster because, your hand may be striking against the other parts of the motorcycle if the adjuster spanner slips out of the pre-load adjuster notch.

Caution

Rear shock absorber to be adjusted only on the left side of the vehicle.

Adjust step by step (3rd to 4th notch and so on). Do not go at a stretch as it will damage the adjuster.

Rebound damping*

The shock absorber is provided with rebound damping force adjustment.

To increase the damping turn the adjuster screw clockwise and to reduce the damping turn the adjuster screw towards anti-clockwise, as shown. (ref. Fig. 42)

During adjustment count the numbers of clicks from fully closed (clockwise) position.



Fig. 42

Note

The motorcycle delivered with adjustable suspension shall be with standard setting, Refer suspension chart for various setting However the mentioned suspension settings are only a guide Setting requirements may vary for rider weight and personal preferences, for further information contact TVS Motor Company Authorised Main Dealer.

Damping chart

Setting	Fork RH (Compression)	Fork LH (Rebound)	Shock Absorber (Rebound)
Standard	10	10	10
Solo (Race Track)	20	4	8
Solo (Comfort)	15	15	14
Rider & Pillion	10	10	10
Rider & Luggage (Touring)	10	10	10
Rider, Pillion & Luggage (not exceeding the limits) (Touring)	10	10	10

Spring preload chart

Setting	Fork RH (Compression)	Fork LH (Rebound)	Shock Absorber (Rebound)
Solo (Race Track)	Standard	Standard	Standard (3 rd notch)
Solo (Comfort)	Standard	Standard	Standard (3 rd notch)
Rider & Pillion	Standard	Standard	5 th notch
Rider & Luggage (Touring)	Standard	Standard	5 th notch
Rider, Pillion & Luggage (not exceeding the limits) (Touring)	Maximum	Maximum	7 th notch

Note

Luggage load should not exceed 10kgs.

Head Lamp Aiming

To check and adjust the head lamp focus:

- Place the motorcycle upright in a uniform flat surface while ensuring the head lamp center (A) is 5 meter away from a vertical wall or screen (B). (ref. Fig. 43)
- Inflate the tyres to the correct pressure.
- Keeping the motorcycle at right angles to its longitudinal axis switch on the 'Low beam' of head lamp.

Two projector lamps need to be adjusted independently as mentioned below:

a. RH side projector adjustment:

- Mask the LH side projector lamp using a black color cloth.
- Adjust the RH side projector lamp adjuster (C) clockwise (Downward) or in anti-clockwise (Upward) and match the low beam cut-off line to the marking line (D) (500 mm) on a vertical wall or screen. (ref. Fig. 43 & 44)

b. LH side projector adjustment:

- Remove the cloth from LH side projector and mask RH projector lamp.

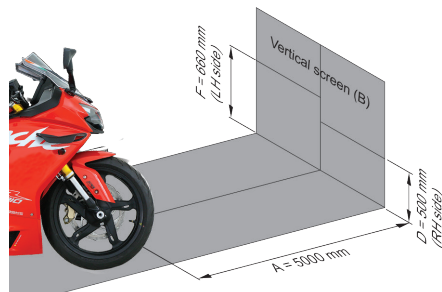

Fig. 43

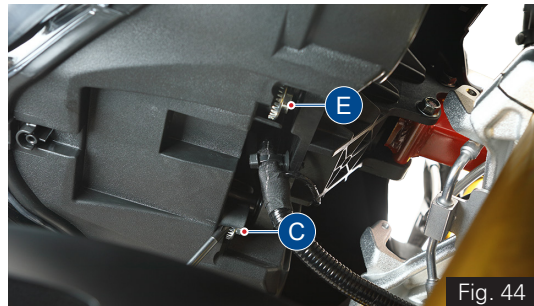

Fig. 44

* The specification for head lamp beam adjustment is applicable only for India. Owner's of other countries are advised to adopt the local rules and regulations.

- Adjust the LH side projector lamp adjuster (E) clockwise (Downward) or in anti-clockwise (Upward) and match the low beam cut-off line to the marking line (F) (660 mm) on a vertical wall or screen. (ref. Fig. 46 & 47)
- Both the projectors low beam cut-off line should match with the marked line on the screen or wall.

Note

Head lamp aiming to be done with the unloaded vehicle only.

Both the projector lamps should be adjusted independently.

The adjustment levels mentioned is for solo riding condition. For dual riding condition, the head lamp beam may be adjusted as per need for better visibility.

Warning

Do not stare at LED head lamp beam to avoid damage to the eyes.

Maintenance Schedule

Maintenance schedule indicates the intervals between periodic services. At the end of each interval, be sure to inspect, check, replace, adjust, lubricate and service as instructed.

If the maintenance service is not done periodically, it will result in rapid wear and severe damage to the vehicle.

If the vehicle is used under high stress conditions such as continuous full throttle operation or rain, is operated in wet or dusty areas, certain jobs should be performed more often to ensure reliability of the vehicle.

Cylinder head, steering components, suspension, chain and wheel components etc. are key items and require very special and careful servicing.

We recommends that the jobs as per the maintenance schedule be performed by your TVS Motor Company Authorised Main Dealer.

Periodic inspections may reveal one or more parts that may need replacement. Whenever replacing any such parts we recommend to use only TVS Motor Company Genuine parts.

Perform pre-ride inspection (ref.page 121) before every scheduled maintenance.

I - Inspect	R - Replace	T - Top-up
C - Clean	A - Adjust	L - Lubricate
TI - Tighten		



Caution

Proper running-in (ref. page 01) and maintenance is mandatory for making certain that your vehicle is reliable and gives optimum performance at all times. make sure that the periodic maintenance is performed thoroughly in accordance with the instruction given in this owner's manual.

Use of non-genuine spares will affects the performance of the vehicle and failure to comply the warranty claims.

Check for any abnormal jerk during ride / any abnormal noise while opening the fuel tank cap / any leak in the fuel system. If found any, contact TVS Motor Company Authorised Main Dealer.

PERIODIC MAINTENANCE SCHEDULE (months or km whichever occurs earlier) - Free service

List of operations and type of intervals (km or month whichever of the two occurs early)	Service	1st	2nd	3rd
	Km x 1000	1	5	10
	Months	2	6	12
Engine oil, filter along with drain bolt washer		R	-	R
Air cleaner element		-	-	R
Spark plug		-	-	-
Tappet clearance (valve clearance)*		-	-	I & A
Clutch operations (adjust if required)		I & A	I & A	I & A
Steering play		I & A	-	I & A
Front and rear suspension		-	-	I
Wheel bearing freeness (replace if required)		-	-	I
Air suction system / engine breather		-	-	I
Front fork oil replacement		-	-	-
All fasteners		I & TI	-	I & TI
Drive chain slackness / lubrication		Inspect, adjust and lubricate every 500 km		
Drive chain wear (replace if required)		-	-	I

* Adjust if necessary

List of operations and type of intervals (km or month whichever of the two occurs early)	Service	1st	2nd	3rd
	Km x 1000	1	5	10
	Months	2	6	12
All lamps and horn		-		
Head lamp beam (focus)		I & A	I & A	I & A
Battery voltage (recharge if required)				
Brake light switch operation				
Front and rear brake fluid level**				R
Front and rear brake pad wear (replace if required)		-		
Disc plates (replace if required)		-	-	
Brake hose / rubber parts of master cylinder and Caliper front and rear (replace if required)		-	-	
Tyre air pressure (at cold condition)		I & A	I & A	I & A
Steering stem bearing (Inspect & lubricate with Grease if required)		I & L	-	I & L
Speed sensor (free from any mud / clogging with dirt)				
Fuel filter		-	-	-

** Replace brake fluid first at 10000 kms and every 20000 kms or 2 years thereafter.

List of operations and type of intervals (km or month whichever of the two occurs early)	Service	1st	2nd	3rd
	Km x 1000	1	5	10
	Months	2	6	12
Coolant level, water hoses and O-rings (replace if required)***				
Fuel hose / system			-	
Swing arm bearing (replace if required)				
Side stand		C, I & L	C, I & L	C, I & L
Side stand switch function and physical damage				
Drive chain guide wear (replace if required)		-	-	
Instrument cluster MIL lamp function				
Radiator fan / fins and deflector (clean if required)				
Reading fault codes using diagnostic tool				
Availability of fuse puller and fuse condition				
Brake pedal / gear shift lever mounting pin (lubricate using grease)				
Ignition cum steering lock (lubricate using oil)				

*** Coolant, hoses and O-rings must be replaced every 30000 kms or every 3 years.
At higher odometer readings, the above service intervals to be followed.

PERIODIC MAINTENANCE SCHEDULE (months or km whichever occurs earlier) - pay service

List of operations and type of intervals (km or month whichever of the two occurs early)	Service	4th	5th	6th	7th	8th	9th	10th	11th
	Km x 1000	15	20	25	30	35	40	45	50
	Months	18	24	30	36	42	48	54	60
Engine oil filter along with drain bolt washer		-	R	-	R	-	R	-	R
Air cleaner element		-	R	-	R	-	R	-	R
Spark plug		-	R	-	-	-	R	-	-
Tappet clearance (valve clearance)*		-	I & A	-	I & A	-	I & A	-	I & A
Clutch operations (adjust if required)		I & A	I & A	I & A	I & A	I & A	I & A	I & A	I & A
Steering play		-	I & A	-	I & A	-	I & A	-	I & A
Front and rear suspension		-	I	-	I	-	I	-	I
Wheel bearing freeness (replace if required)		-	I	-	I	-	I	-	I
Air suction system / engine breather		-	I	-	I	-	I	-	I
Front fork oil replacement		-	R	-	-	-	R	-	-
All fasteners		I & TI	-	I & TI	-	I & TI	I & TI	-	I & TI
Drive chain slackness / lubrication		Inspect, adjust and lubricate every 500 km							
Drive chain wear (replace if required)		-	-	I	-	I	I	-	I

* Adjust if necessary

List of operations and type of intervals (km or month whichever of the two occurs early)	Service	4th	5th	6th	7th	8th	9th	10th	11th
	Km x 1000	15	20	25	30	35	40	45	50
	Months	18	24	30	36	42	48	54	60
All lamps and horn		I	I	I	I	I	I	I	I
Head lamp beam (focus)		I & A	I & A	I & A	I & A	I & A	I & A	I & A	I & A
Battery voltage (recharge if required)		I	I	I	I	I	I	I	I
Brake light switch operation		I	I	I	I	I	I	I	I
Front and rear brake fluid level**		I	R	I	R	I	R	I	R
Front and rear brake pad wear (replace if required)		I	I	I	I	I	I	I	I
Disc plates (replace if required)		-	I	-	I	-	I	-	I
Brake hose / rubber parts of master cylinder and Caliper front and rear (replace if required)		-	I	-	I	-	I	-	I
Tyre air pressure (at cold condition)		I & A	I & A	I & A	I & A	I & A	I & A	I & A	I & A
Steering stem bearing (Inspect & lubricate with Grease if required)		-	I & L	-	I & L	-	I & L	-	I & L
Speed sensor (free from any mud / clogging with dirt)		I	I	I	I	I	I	I	I
Fuel filter		-	R	-	-	-	R	-	-

** Replace brake fluid first at 10000 kms and every 20000 kms or 2 years thereafter.

List of operations and type of intervals (km or month whichever of the two occurs early)	Service	4th	5th	6th	7th	8th	9th	10th	11th
	Km x 1000	15	20	25	30	35	40	45	50
	Months	18	24	30	36	42	48	54	60
Coolant level, water hoses and O-rings (replace if required)***									
Fuel hose / system		-		-		-		-	
Swing arm bearing (replace if required)									
Side stand		C, I & L	C, I & L	C, I & L	C, I & L	C, I & L	C, I & L	C, I & L	C, I & L
Side stand switch function and physical damage									
Drive chain guide wear (replace if required)		-		-		-		-	
Instrument cluster MIL lamp function									
Radiator fan / fins and deflector (clean if required)									
Reading fault codes using diagnostic tool									
Availability of fuse puller and fuse condition									
Brake pedal / gear shift lever mounting pin (lubricate using grease)									
Ignition cum steering lock (lubricate using oil)									

*** Coolant, hoses and O-rings must be replaced every 30000 kms or every 3 years.
At higher odometer readings, the above service intervals to be followed.

Safety Precautions

Before you are starting any maintenance repairs,

- Make sure that engine is in OFF condition. This will help in eliminating several potential hazards like:
 - Poisoning from engine exhaust Carbon Monoxide (be sure there is proper ventilation whenever engine is operated in indoor).
 - Let the engine and exhaust to cool before working on the motorcycle to avoid burns from hot parts.
 - Do not run the engine without instruction for doing the same to avoid injury from moving parts.
- Carefully read the instruction before starting, and ensure that you have tools and skill required for doing the maintenance service.
- Park the vehicle on a flat firm surface with the side stand, center stand (if available) or the auxiliary stand (paddock stand refer page 181) to prevent the motorcycle from falling while doing the maintenance service.

- While working on batteries or fuel related items care must be taken to avoid fire or explosion. Use non-flammable solvent only. Keep away the fire (like cigarettes, sparks and flames etc.) from the battery and fuel related items.
- Ensure to remove the head lamp fuse, to avoid battery discharge during working.

Note

We recommend that the maintenance jobs as per the planned maintenance schedule be performed by your TVS Motor Company Authorised Main Dealer. Trained service personals of the Dealer can provide quality, reliable and economical service to your vehicle.

Use only TVS Motor Company Limited Genuine parts for long and reliable life of your motorcycle.

Engine Oil Level

Ensure the safety precautions listed in the page 147 are followed properly.

Check the engine oil level before riding the motorcycle. Insufficient engine oil or too much engine oil affects the engine adversely.

To check the engine oil level, a gauge oil level (dip stick) (A) given on the left side of the crankcase (ref. Fig. 45).

- Wipe off the surroundings of the gauge oil level. Start the engine and let it idle for 3 to 5 minutes.
- Switch OFF of the ignition. Hold the vehicle in upright condition with both the wheels on ground, on a flat and firm surface.
- After 2 to 3 minutes, remove the gauge oil level (A) and wipe it cleanly.
- Re-fix the gauge again. Slowly and steadily remove the gauge and inspect the oil level.
- The level should be between minimum (1) and maximum level (2) mark on the gauge (ref. Fig. 46).
- If the level is below the minimum level (1), slowly add recommended engine oil till the level reaches to maximum level (2).

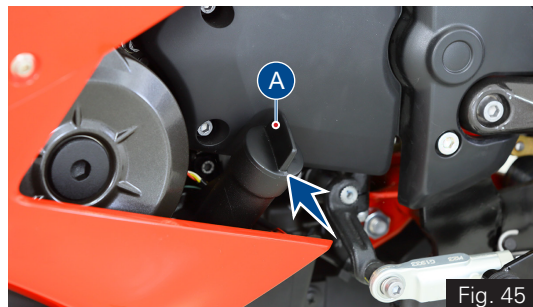

Fig. 45



Fig. 46

- Re-fix gauge after ensuring correct oil level.
- Wipe out the oil traces with a clean cloth to prevent dust accumulation.
- Re-fix gauge after ensuring correct oil level.
- Wipe out the oil traces with a clean cloth to prevent dust accumulation.

 **Caution**

Running the engine with insufficient or excess engine oil may cause serious damage to the engine.

For topping-up, always use TVS Motor Company recommended engine oil only.

Hold the vehicle in upright condition with both wheels on ground, on a flat and firm surface while checking the oil level to avoid wrong indication.

Engine oil and oil filter must be replaced by a TVS Motor Company Authorised Main Dealer at the intervals specified in the planned maintenance schedule without fail. Failing which disqualifies for warranty.

 **Warning**

Correctly recycle or dispose the used engine oil in order to avoid environment pollution.

Clutch Free Play

Ensure the safety precautions listed in the **page 147** are followed properly.

Clutch free play adjustment may be required if the motorcycle gets OFF while shifting from neutral to gear or tends to creep; or if the clutch slips (vehicle acceleration lags behind the engine rpm).

Minor clutch free play adjustment can be done by means of clutch cable adjuster at the clutch lever end.

- Measure the clutch free play (A) at the lever end as shown (ref. Fig 47).
 - If the measured free play is 'more' or 'less' than the standard limit given below:

Clutch lever free play	8 to 12 mm
------------------------	------------

- Remove the cable clamp (1). Pull back the dust cover (2) of clutch lever (ref. Fig. 48).
- Loosen the lock nut (3) and turn the adjuster (4) 'in' or 'out' till the specified play is obtained (ref. Fig. 50).
 - After the adjustment, once again check the free play and confirm.



Fig. 47

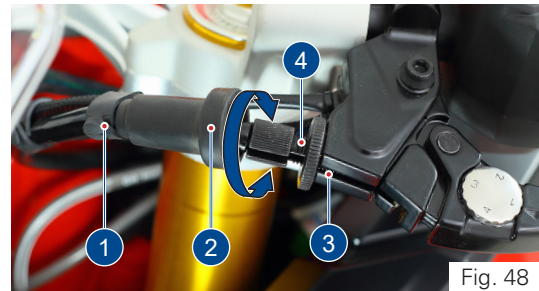

Fig. 48

- Lock the lock nut (3) again.
 - If the adjuster is threaded out to its maximum limit or if the correct free play cannot be obtained using the cable adjuster, loosen the lock nut and completely turn-in the clutch cable adjuster.
- Re-fix the dust cover (2) and cable clamp (1).
- Loosen the lock nut (5) at the bottom end of the clutch cable (ref. Fig. 49).
- Turn the adjuster in (6) 'in' or 'out' until the specified play is obtained and then tighten the lock nut and check the adjustment once again (ref. Fig. 51).
 - After adjusting the clutch play, start the engine and engage the gear. Ensure that the engine is not stalling and not creeping.
 - Gradually release the clutch lever while slowly applying the throttle. The vehicle should begin to move slowly and accelerate smoothly. Else contact TVS Motor Company Authorised Main Dealer.

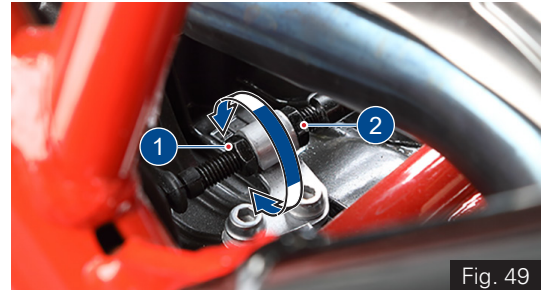

Fig. 49

⚠ Caution

Clutch play free play should be checked and adjusted only when the engine is cold.

During clutch play checking and adjustment, check the clutch cable for kinks or sign of wear that could cause stickiness or failure.

Lubricate the clutch cable using a cable lubricant available in the market to prevent premature failure and corrosion.

Brake Fluid Level

Brake fluid level should not fall below the MIN level mark on both front and rear brake fluid reservoir. If the level drops below the limit, air can get into the circuit and make the system ineffective.

Brake fluid must be topped up and changed at the intervals specified in planned maintenance schedule without fail for the proper working and to ensure the safety of the rider.

- Switch OFF and place the vehicle upright on a flat and firm surface using centre stand (if available) or on a auxiliary stand (**paddock stand ref. page 181**).

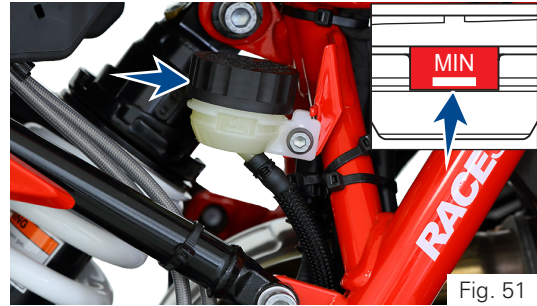

Fig. 51

- Keep the handle bar straight.
- Inspect the oil level of both front and rear brake fluid reservoirs (ref. Fig. 50 & Fig. 51).
- If the level is lower than the MIN level mark in any of the reservoir, contact TVS Motor Company Authorised Main Dealer for topping up.
- If you find excessive play (sponginess) in the front brake lever or in the rear brake pedal, but both the brake pads are still in good condition, contact TVS Motor Company Authorised Main Dealer for the inspection of system and to do the air bleeding.



Fig. 50

Note

Check the brake fluid level only when the handle bar and vehicle is in straight condition.

Warning

Lack of maintenance of the brake system increases the risk of accident. If you notice any malfunction in the brake system contact nearest TVS Motor Company Authorised Main Dealer for further diagnosis.

Caution

Inspect for any leakage of fluid in the brake circuit.

Cover the body parts with a protective cover before topping up the brake fluid to prevent the painted parts from getting damaged. In case of any fluid dripping on body panels, it is recommended to be cleaned immediately.

Use only BASF (DOT 4) brake fluid from a sealed container or drain the existing brake fluid completely from the circuit and use another brand (DOT 4) brake fluid to avoid mix up with existing old and different brand fluid.

Brake Pad Wear

- Visually inspect both front brake pads wear and rear brake pads wear.

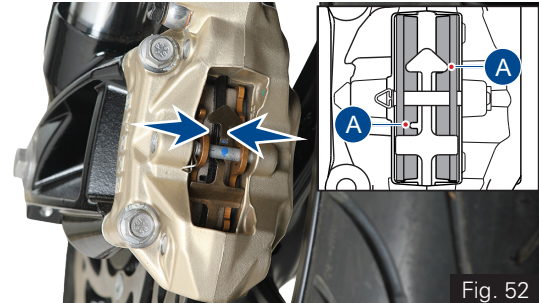

Fig. 52

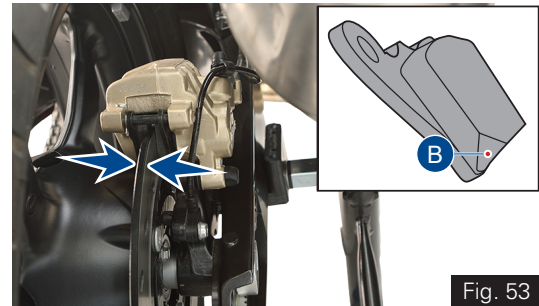

Fig. 53

- If the wear is found beyond the wear indicator (A & B) groove as shown in the figure in any one of the pad, replace brake pads as a set with a new one. (ref. Fig. 52 & 53)

 **Warning**

If the brake pads are used beyond this groove, leads to metal support contact with the brake disc and affects the braking efficiency, disc integrity and leads to unsafe riding conditions to the rider.

 **Caution**

Replace the brake pads as a set, if the wear indicator shows beyond the wear limit.

Rims and Tubeless Tyres

Ensure the safety precautions listed in the **page 147** are followed properly.

Rims

- Visually inspect the front and rear wheel rims for any defects. If found any, have the rims inspected at TVS Motor Company Authorised Main Dealer and get it replaced if necessary.

Tyre pressure

Check the tyre pressures atleast once in a week if not more frequently. Insufficient tyre pressure not only fasten tyre wear, but also seriously affects the stability of the vehicle and may lead to rim bend or damage.

- Under-inflated tyres make smooth cornering difficult and over-inflated tyres decreases the contact with the ground which can lead to skidding and loss of control.
- As the tyre pressure is affected by changes in the temperature and altitude, check and adjust the pressure more frequently whenever your vehicle is used on such conditions.
- Be sure that the tyre pressures are within the specified limit at all times.

	Solo / Pillion
Front	2.25 kg/cm ² (32 PSI)
Rear	

Warning

The tyre inflation pressure in cold condition is extremely important for the performance and the safety of the rider. Improper tyre pressure may result in: stability and handling issues, wobbling, hard steering, bumpy ride, uneven tyre wear etc.

When minor puncture occurs, tubeless tyres take a long time to deflate, as they tend to hold the air inside. If the tyres is found with low pressure, check the tyres for puncture.

Check and adjust the tyres pressure only when the tyres are cold.

Be sure to tighten the valve dust caps securely to prevent leaks while riding.

Ensure correct tyre pressure to avoid rim bend or damage.

Tyre tread condition

Whenever the tyre pressure is checked, ensure to check the tyre treads and side walls for wear, damage and foreign objects.

The tyres also to be checked for:

- Bumps or bulges in the sides of the tyre or in the tread.
- Cuts, splits or cracks in the tyre (replace the tyre without fail if found any of the above issues to ensure the safety of the rider).
- Replace the tyre when the tyre wears off to the tyre wear indicator level (1) which is indicated by the tyre wear indicator (TWI) mark (2) on the side surface of the tyre (ref. Fig. 54).



Fig. 54

- Tread depth of the tyre should be minimum 2 mm if the vehicle speed is higher than 100 kmph, and it shall be minimum 1 mm if the vehicle speed is lesser than 100 kmph.

Tread depth (min) :	2 mm (> 100 kmph)
	1 mm (< 100 kmph)

Warning

Visually inspect the tyres at regular intervals for cracks and cuts, especially on the side walls, and bulges or large stains that indicate internal damage. Replace them if damaged.

Remove any stones or other foreign bodies stuck in the tread.

Note

Tread wear marks are integrated into the main grooves on every tyre. If the tyre tread has worn down to the level of the marks, the tyre is completely worn. The location of the tread wear marks are indicated by an aero mark on the edge of the tyre (ref. Fig. 48). Replace the tyre when the minimum tread depth is reached.

Tyre replacement

- The tyres fitted on your motorcycle were designed to match the performance capabilities of your motorcycle and provide the best combination of handling, braking durability and comfort. The recommended tyres for your motorcycle are:

Front	110/70-R17 M/C 54H Tubeless / 110/70 ZR17 M/C 54W Tubeless
Rear	150/60-R17 M/C 66H Tubeless / 150/60 ZR17 M/C 66W Tubeless



Fig. 55

- While re-assembling the tyre, ensure that the arrow mark (1) provided on the side walls of the tyre faces the direction of wheel rotation (ref. Fig. 55).

Warning

Have the tyres replaced at only TVS Motor Company Authorised Main Dealer or Michelin Authorised Dealer. Proper removal and reassembly of wheels and the tyres are essential.

Use only the recommended tyre. Use of a tyre other than the standard will cause instability. Be sure the wheel is balanced after the new tyre is installed.

Caution

Side walls of the tubeless tyres which are in contact with the wheel rim are only seals the air inside the wheel assembly. Hence, care should be taken not to damage the side walls of the wheel rim during removal and reassembly of the tyres.

 **Note**

Wheel balancing to be done every 1 year or every 10000 km. In addition, after every tyre puncture repair or replacement, wheel balancing to be done without fail. Do not remove or alter the position of wheel balancing weights after the completion of wheel balancing.

Tyre repair

- Do not repair the punctured tyre and it should be only replaced. If it is necessary to ride on a repaired tyre, never exceed the vehicle speed above 100 kmph until the tyre is replaced.

 **Warning**

Do not repair the punctured tyre. It should not be replaced. If it is necessary to run the vehicle on a repaired tyre, never exceed 100 kmph speed until the tyre is replaced.

Never install a tube inside a tubeless tyre on this motorcycle. The tube may get burst during ride due to excessive heat buildup which will result in serious consequences.

 **Warning**

Since the rims of this motorcycle is designed for tubeless tyres, use tubeless tyres only. During hard acceleration or braking, a tube tyre could slip on the rim and deflate rapidly.

Drive Chain

Ensure the safety precautions listed in the **page 147** are followed properly.

The drive chain's service life is purely depended upon the proper lubrication and adjustment. Poor maintenance of drive chain can cause premature wear or damage to the drive chain and sprockets.

The drive chain must be inspected, cleaned, adjusted and lubricated as per the planned maintenance schedule. Under severe usage, or when the motorcycle is used more dusty or muddy areas, more frequent maintenance is necessary.



Fig. 56

Slackness inspection

- Ensure the engine is turned OFF and the vehicle is in neutral.
- Place the motorcycle on its centre stand (if available) or side stand or in auxiliary stand (**paddock stand ref. page 181**).
- Using the fingers, check the slackness of the chain at the lower portion, midway (A) between the sprockets (ref. Fig. 56).
- The slackness (A) should be between 30 to 40 mm at the various points of the chain.

Drive chain slackness	30 to 40 mm
-----------------------	-------------

- The chain should be adjusted at the point of least deflection.

Adjustment

- Place the vehicle on centre stand (if applicable) or side stand or auxiliary stand (paddock stand) on a flat firm surface.
- Loosen the rear axle nut (1) using a proper spanner from the tool kit (ref. Fig. 50).
- Release the lock nuts (2 & 3) (ref. Fig. 60 & 61) using proper spanner from the tool kit (**ref. page 180**).

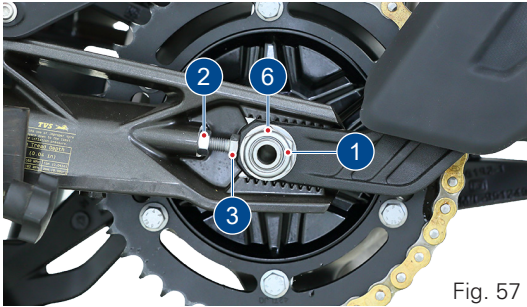

Fig. 57

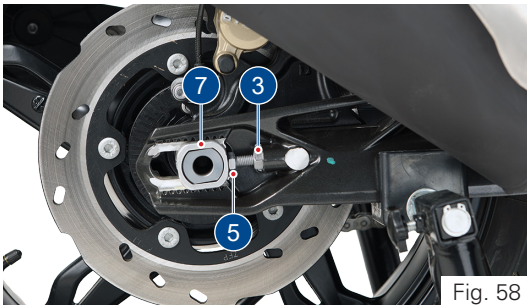

Fig. 58

- Turn the adjuster screws (4 & 5) 'in' or 'out' to obtain the specified slackness in the chain (ref. Fig. 59 & 60).
- While ensuring that the notch in the chain adjuster (6 & 7) is adjusted to the same scale value on both left and right sides, tighten the locknuts to the specified torque.
- Similarly, tighten the rear axle nut and lock nut to the specified torque, and check and ensure the chain slackness (ref. Fig. 57 & 58).

Axle nut tightening torque	100 ± 15 Nm
Lock nut tightening torque	19 ± 3 Nm

Caution

Chain can be adjusted when vehicle is supported by centre stand (if applicable) or side stand or auxiliary stand (paddock stand) in no load condition.

Always have these tightening torques to be checked at TVS Motor Company Authorised Main Dealer after assembly for safety.

Cleaning

- Slowly rotate the rear wheel in driving direction or wheel rotation direction and spray the recommended cleaning spray.
- Leave the cleaning solvent to soak for few minutes. Wipe off the solvent on the chain with a dry, clean cloth thoroughly. Use a soft brush if the chain is dirty.

Lubrication

- Ensure the chain is cleaned thoroughly and the solvent is wiped off completely.



Fig. 59

- Slowly rotate the rear wheel in driving direction or wheel rotation direction. Apply recommended spray liberally as shown to the drive chain inner lower runs (ref. Fig. 59).
- Ensure both the row links are lubricated.

Warning

Avoid getting lubricant on the brakes or tyres. Avoid applying excess chain lubricant to prevent spray onto your clothes and the motorcycle.

Caution

The chain fitted on your motorcycle has X-Rings to protect the moving parts of chain from dirt, and to hold the lubricant inside. If the chain is cleaned using any solvent other than those specific for X-ring chains or washed using steam or water cleaners or a wire brush or an abrasive cleaner, the X-ring seals might be damaged irreparably.

Use only MOTUL C2 spray to lubricate the chain. Using non-specific lubricants may cause severe damage to the chain and the front and rear sprocket.

Front Wheel

Ensure the safety precautions listed in the **page 147** are followed properly.

Removal

- Carefully place the motorcycle in auxiliary stand (**paddock stand ref. page 181**).
- Loosen the left side clamping screws (1) and (2) (ref. Fig. 60).



Fig. 60

- Remove the locking screw (3) (ref. Fig. 61).
- Loosen the right side clamping screws (4) and (5).
- Slightly press the quick-release axle (6) inward for a better grip on the right side.

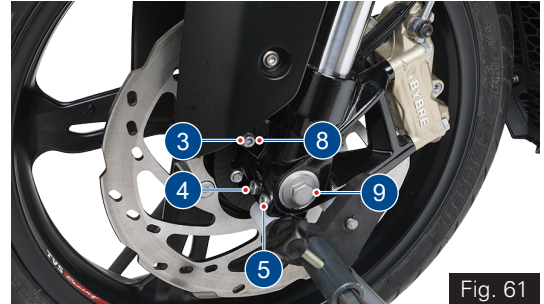

Fig. 61

- Support the front wheel and slowly pull out the quick-release axle (6) from the left side. (ref. Fig. 62).



Fig. 62

- Place the front wheel down and roll it forward out of front suspension. Ensure not to damage the wheel speed sensor during the removal process.
- Take out the spacer bush (7) from the left side of the wheel hub (ref. Fig. 63).

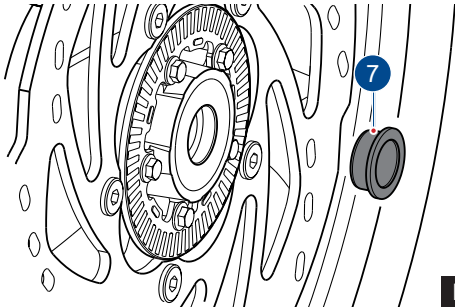
Fig. 63

Caution

Ensure not to damage the brake caliper during wheel removal.

Do not actuate the brake lever after the wheel is removed. Unintentional press of brake lever leads to brake pads binding.

Note

During the wheel removal, take additional care to prevent the wheel rims from scratches.

Reassembly

- Push the brake pads of front caliper away from together to ease the front wheel entry in to front suspension.
- Loosen the mounting screw (8) and take out the speed sensor (9) from front suspension.
- Fix the spacer bush (7) on the left side of wheel hub (ref. Fig. 63).
- With the care, roll the front wheel into the front suspension so that there is no damage to the wheel speed sensor.
- Lift the front wheel. While ensuring the proper seating of brake disc into the caliper assembly, insert the quick release axle.
- Remove the front wheel stand and stroke the front fork several times without applying the brake.
- Mount the front wheel stand again and install the locking screw (3) with specified torque (ref. Fig. 62).

Tightening torque	50 ± 7 Nm
-------------------	---------------

- Install the clamping screws (1,2,4 & 5) and tighten to the specified torque (ref. Fig. 63 & 64).

Tightening torque	19 Nm
-------------------	-------

- Assemble the speed sensor (9) and mounting screw (8) in front suspension.

 **Caution**

Always have these tightening torques to be checked at TVS Motor Company Authorised Main Dealer after assembly for safety.

Rear Wheel

Ensure the safety precautions listed in the **page 147** are followed properly.

Removal

- Carefully place the motorcycle in auxiliary stand (**paddock stand ref. page 181**) or centre stand (if available).
- Place a support below the rear wheel to avoid falling of wheel after removing the quick release axle.
- Remove the mounting screw (1) from the speed sensor mounting and carefully take out the speed sensor (2). (ref. Fig.64)

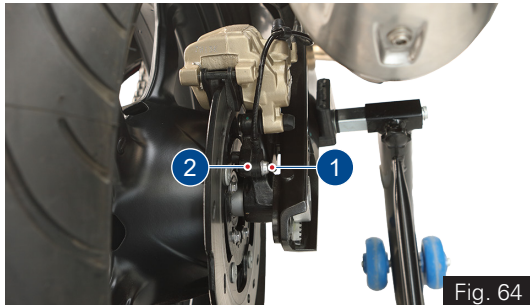

- Remove the axle mounting nut (3, ref. Fig 65 using the proper tool from the tool kit (ref. page 180).

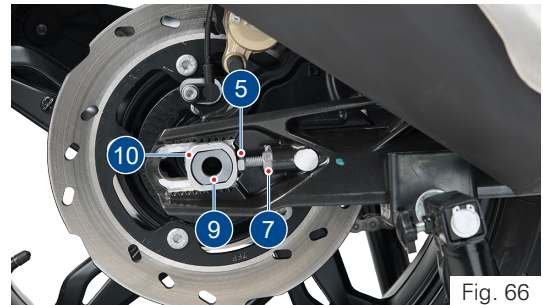
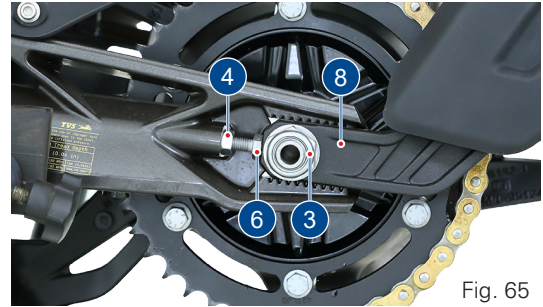

- Release the lock nuts (4 & 5) and screw-in the adjuster bolts (6 & 7) (ref. Fig. 65 & 66).
- Remove the chain tensioner with hugger (8) and push the quick-release axle to the right as much as possible (ref. Fig 65).
- Carefully pull out the quick release axle (9) from the left side and take out the chain tensioner (10) (ref. Fig. 66).
- Roll the rear wheel forward as far as possible and disengage the chain (11) from the sprocket (ref. Fig. 67).
- Care should be taken not to damage the wheel speed sensor during this process.



Fig. 67

- Carefully roll the rear wheel out from the swing arm while pulling the brake-caliper assembly back far enough to allow the rear wheel to come out.

Caution

Care should be taken not to damage speed sensor during its removal and reassembly. Ensure that the speed sensor is free from any mud / clogging with dirt.

Ensure not to damage the brake caliper during wheel removal.

Do not actuate the brake pedal after the wheel is removed. Unintentional press of brake pedal leads to brake pads binding.

Note

Sprocket assembly, spacer axle rear LH & RH are loose fits in the wheel. Make sure that no parts are damaged or mislaid during removal and reassembly of the wheel.

During wheel removal, take additional care to prevent the wheel rims from scratches.

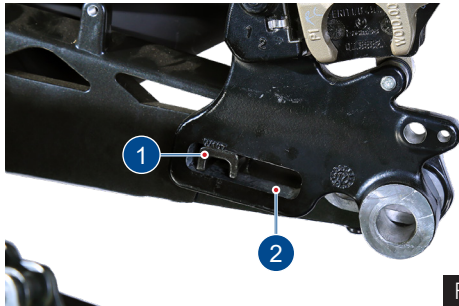

Fig. 68

Reassembly

- Carefully roll the rear wheel on the support into the swing arm, along with LH & RH spacers and sprocket, as far as necessary to allow the brake-caliper to be inserted while taking care of wheel speed sensor.
 - Push the brake pads away from together to ease the rear wheel entry into swing arm.
 - Place the brake-caliper (1) on the guide (2) of the swing arm as shown (ref. Fig. 68)
 - Roll the rear wheel further into the swing arm, while pushing the brake-caliper assembly forward at the same time.
- Roll the rear wheel as far forward as possible and loop the chain over the sprocket.
 - Insert the quick-release axle along with the chain tensioner from left side of the swing arm while ensuring that the axle is seated properly into all the components.
 - Assemble the left side chain tensioner.
 - Assemble the axle nut along with the washer and hand tighten it.
 - Adjust the chain slackness and tighten the lock nuts, and the axle nut to the specified torque (**ref. page 203**).
 - After tightening the axle nut, once again check and confirm the chain slackness.
 - Assemble the speed sensor (2) and mounting screw (1) in rear caliper (ref. Fig. 64).

**Caution**

Chain can be adjusted when vehicle is supported by centre stand (if applicable) or side stand or auxiliary stand (paddock stand) in no load condition.

Always have these tightening torques to be checked at TVS Motor Company Authorised Main Dealer after assembly for safety.

Battery

Ensure the safety precautions listed in the **page 147** are followed properly.

Since the maintenance free battery is used in your motorcycle, it is not necessary to check the battery electrolyte level or add distilled water.

If your battery seems weak i.e. if you are facing starting issues or other electrical issues, contact TVS Motor Company Authorised Main Dealer.

Removal

- Turn OFF the ignition.
- Remove the pillion and rider seats as explained in **page no. 119** to access battery.



Fig. 69

- Remove the mounting bolt and take the battery holder (A) (ref. Fig. 69)
- Disconnect the negative terminal (1) first followed by the positive terminal (2) (ref. Fig. 70). Carefully take out the battery.



Fig. 70

Re-fitment

- Reinstall the battery in the reverse order of removal.
- Connect the positive terminal first and then the negative firmly to avoid any damages to electrical system / battery. Make sure the rubber boot is intact with positive terminal.

 **Warning**

Battery develop explosive gases. Keep it away from heat sources. If charging is required, the battery must charged in well ventilated area.

Unusable battery must be disposed in environment friendly manner. Do not discard it with household trash. Handover the battery to the battery Dealers or to a recycling centre that accepts used batteries.

 **Caution**

Never operate the motorcycle with discharged battery as it may damage electrical components.

Do not push start the vehicle, use a good battery or jump cable to start the vehicle incase of battery drain.

 **Note**

If the motorcycle is to remain unused for a long time (a month or longer), it is advisable to disconnect the battery terminals or have the battery removed by a skilled personnel.

Fuses

The electrical components of your motorcycle are protected by six fuses housed inside a fuse box and located below the rider seat.

To access the fuses, park the motorcycle on a flat and firm surface and remove the pillion and rider seats as explained in **page no. 119**.

A 'fuse puller' (A) on the battery holder can be used to pull out the fuse from the fuse box during replacement.

Removal and replacement

- Turn OFF the ignition.
- Press the lock and open the fuse box cover (1) (ref. Fig. 71).

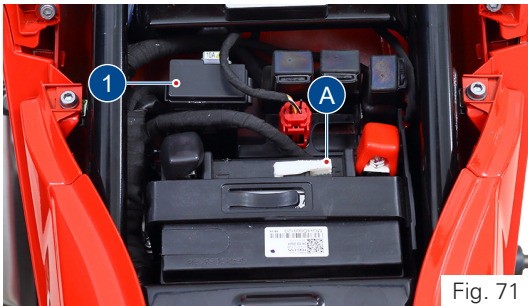

Fig. 71

- Pull out the defective fuse and re-fix the new one with same rating.
- Close the fuse box cover and ensure the proper locking.

You can identify a blown fuse by the interrupted centre link (1) (ref. Fig. 72).

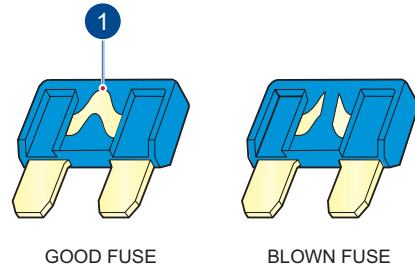

Fig. 72

Fuse assignments

- Each fuse inside the fuse box are assigned for different electrical load and it is listed the table given below. Never change the fuse rating to protect your electrical system and to avoid severe damages.

Fuse arrangement

- Fuses are arranged inside fuse box as given in the figure (Fig.73). Ensure to fix the right rating fuse at right location.
- An additional 10A HECU protection fuse (2) is provided out side the fuse box as shown in thefigure (ref. Fig. 74). Ensure to check this fuse incase if any HECU related electrical issue is found in the system.

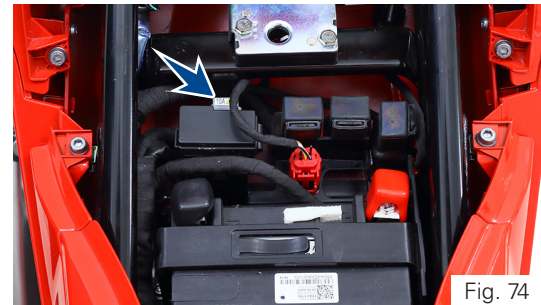

Fuse	Colour	Electrical load
F1 - 7.5A	Brown	Lambda / purge valve / ECU / REL coils / injector / ignition coil/ main relay / speedo
F2 - 7.5A	Brown	Fan radiator
F3 - 30A	Green	Main fuse
F4 - 15A	Blue	HECU
F5 - 15A	Red	All lights / horn LH & RH / USB charger
F6 - 10A	Red	EFI / Speedometer /Telematic
	Red	HECU

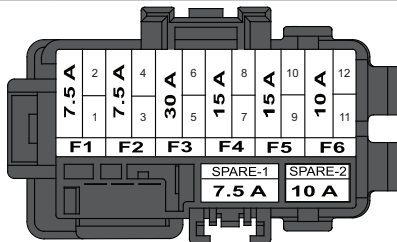

FUSE BOX

Fig. 73

Caution

Do not use the motorcycle by shorting the wires without a fuse. Never use a fuse with a rating other than that specified. Failure to observe above rules may damage the electric system or even cause fire.

Note

A sticker with fuse colour codes and rating is pasted inside the fuse box cover which can be referred during fuse replacement.

Ensure to replace the 'fuse puller' in the same place for future usage.

Care should be taken not to spray water on electrical components.

Spare fuse location

- Spare fuse for the each of the fuse is located inside the fuse box (A) and as well as in the wiring harness (B) below the seat latch of pillion seat (ref. Fig. 75).



Fig. 75

Mirror Assembly

Ensure the safety precautions listed in the **page 147** are followed properly.

Assembly

- Remove the allen screw (2 nos) from the bracket licence complete using a hexagonal key 5 mm from the tool kit (ref. page 180) (ref. Fig. 76).
- Assemble the mirror assembly LH to the bracket licence complete along with grommets (2 nos) on both sides bracket licence complete.

- Now tighten the allen screw (2 nos) with the bracket licence complete using a hexagonal key 5 mm from the tool kit (ref. Fig. 77).

Tightening torque	7 ± 1 Nm
-------------------	--------------

- Similarly assemble the mirror assembly RH.



Fig. 76



Fig. 77

Diagnostic Connector

The diagnostic connector is located below the rider seat. Follow the procedure given below to access the connector.

Removal

- Park the motorcycle on a flat and firm surface and remove the pillion and rider seats as explained in page no. 119.
- Turn OFF the ignition.
- Gently pull out connector along with its cap from its location by releasing the lock (1) (ref. Fig. 78).
- Release the lock of the cap and take out the cap carefully.

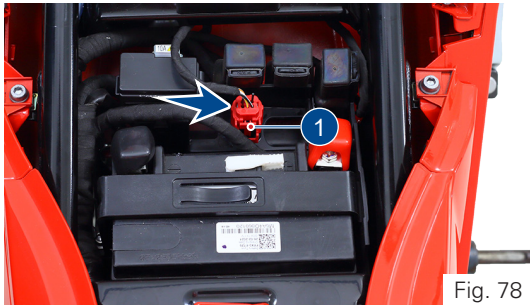

Fig. 78

Re-fixing

- Re-fix the cap of the connector and ensure the proper locking.
- Re-fix the connector to its location and lock it properly.

Caution

Diagnostic connector to be accessed and used by the trained personals of TVS Motor Company Authorised Main Dealer or by the other authorised persons of TVS Motor Company Limited during service. Do not fiddle with system at unauthorised service location.

Ensure to re-fix the diagnostic coupler cap after the usage to avoid damages to the electric system due to water entry. Secure the connector in it's location without fail to avoid getting damaged.

Cleaning your Motorcycle

For maintaining the original shine on metal parts surface and painted parts surface, wash and clean your motorcycle at regular intervals depending on usage and particular road conditions.

- Use only specific products. Avoid aggressive detergents and solvents.
- Use only water and natural soap to clean glass and the seat.
- To prevent stains, do not wash the vehicle immediately after it has been exposed to strong sunlight and do not wash it in the sun.
- If the parts of the engine are unusually dirty or greasy, use a de-greasing agent while taking care of transmission components (like chain, front and rear sprockets, etc.).



Caution

Never clean the motorcycle using hot or high pressure water jets. Cleaning the motorcycle with high pressure water jet may lead to serious problems in front fork, wheel assemblies, brakes, electrical systems, inlet and exhaust systems which will result in reduced safety.

- Transmission components can be rinsed with warm water and dried with clean dry cloth.
- Clean the radiator regularly. Use a hose with low water pressure to clean the radiator fins blockage. This prevents the engine from overheating due to insufficient cooling. Care should be taken not to damage the radiator fins during cleaning.



Warning

There may be a loss of braking efficiency immediately after washing the motorcycle. Greasing or lubricating the brake discs leads to loss of braking. Oil-free solvent to be used for cleaning the brake discs.

The head lamp may be get fogged up after washing, rain or moisture. Switch ON the head lamp for a short period of time to dry any condensation.

Maintain minimum distance of 60cm between the water jet nozzle and the vehicle. Do not direct the jet onto electrical component and connectors.

Storage Procedures

For storing your motorcycle for longer periods of over a month and above, we recommend to carry out the following steps:

- Clean the motorcycle. Park the vehicle on centre stand (if applicable) or in auxiliary stand (**refer page 181**).
- Warm-up the engine and drain the engine oil.
- Empty the fuel tank.
- Remove the spark plug and feed in several drop of engine oil through the spark plug hole. Crank the engine few times and reinstall the spark plug.
- Disconnect and remove the battery. Store it away from direct sunlight and freezing temperatures. Place a suitable support at the bottom of the frame so that both the tyres are off the ground. This will ensure the better tyre life.
- Protect the vehicle with the suitable cover and store the vehicle inside a garage or similar area to avoid damage due to dust and rain.
- Make sure that the storage area is well ventilated and free from any source of flame or spark.



Caution

Do not park the vehicle on a slope or soft ground or else it may fall.

During storage the battery must be checked and if required recharged atleast once in a month.

Restoring the Motorcycle to use

- Take the motorcycle out of garage and clean the motorcycle thoroughly (**ref. page 176**).
- Remount the battery after bench charging if required.
- Fill the engine oil and check the oil level using the gauge.
- Lubricate the necessary parts.
- Fill up fresh fuel in the fuel tank (**ref. page 116**).
- Check and inflate the tyre pressure to the specified limit.
- Check and correct the points mentioned in pre-ride check (**ref. page 121**).

Note

Turn on the ignition and start the engine. Allow the to run in idle mode for few minutes and ride out.

Taking Long Trips

When taking the motorcycle a long trip more than 500 km follow the instructions given below:

- A) Keep the following items for use incase of emergency
- Complete tool kit and first aid kit.
 - Recommended spark plug one number.
 - Clutch cable each one.
- B) Precautions to be taken for the journey:
- Ensure engine oil and brake fluid level are upto the mark.
 - Ensure the coolant level.
 - Adequate fuel in the tank.
- C) Check the motorcycle for the following:
- Tightness of all fasteners for the correct torque value.
 - Fitness of tyres and tyre pressure.
 - Working of all the lamps and horn.
 - Balancing of wheel.
 - Smooth functioning of all cable and their free plays.
 - Smoothness of steering operation.

- Slackness and lubrication of chain.
- Front and rear brake functioning and rear brake switch working.
- Front fork for any abnormality.
- Spark plug cleanliness and condition.
- Air filter element cleanliness.
- Lubrication of all necessary parts.
- Any other jobs as necessary.



Caution

Long journey are to be taken only after the running-in (ref. page 01).

Have your vehicle checked for the above mentioned items at TVS Motor Company Authorised Main Dealer.



Note

Ensure the first aid equipments are changed periodically based on the expiry.

Tool Kit

To assist you in performing certain aspects of periodic maintenance and emergency repairs, a tool kit is supplied along with the vehicle.

- The tool kit (A, ref. Fig. 79) is located below the pillion seat (**ref. page 119** for seat removal procedure).
- The tool kit consists of one number each of the following:
 1. Tool bag
 2. Double ended open jaw spanner 12x13
 3. Double ended open jaw spanner 10x16

4. Bit +/-
5. Grip driver
6. Adjuster shock absorber rear
7. Handle ring spanner
8. Hexagonal key 5 mm
9. Ring spanner

Note

It is recommended to use the tool kit incase of any emergency only. It is always advisable to take your vehicle to TVS Motor Company Authorised Main Dealer.



Fig. 79

Auxiliary Stand (Paddock Stand)

Front wheel stand (ref. Fig. 80, 81 & 82)

Place the motorcycle on its centre stand (if applicable) or on rear wheel stand (ref. page 183) on a flat firm surface.

Use the auxiliary stand supplied for lifting the front wheel (the stand is an accessory and it is available with the TVS Motor Company Authorised Main Dealer).

- Loosen the clamping screws (1) of the stand adapters.
- Move away the adapters (2 & 3) in such way that the front forks fit between them.



Fig. 80

- Centre the stand relative to the front wheel and push it against the front axle.
- Align the two adapters (2a & 3a) so that the front forks are securely seated.



Fig. 81



Fig. 82

- Apply uniform pressure to push the stand down and raise the motorcycle. (ref. Fig. 83)



Fig. 83

- Tighten the clamping screws (1).

Caution

Centre stand (if available in the vehicle and parked using it) retracts if the motorcycle is lifted too high.

When raising the motorcycle, make sure that the centre stand (if available in the vehicle and parked using it) remains on the ground. Else the motorcycle is supported by the rear wheel stand to avoid falling of the motorcycle.

Rear wheel stand

Use the rear wheel stand (the rear wheel stand is an accessory and it is available with the TVS Motor Company Authorised Main Dealer).

- Ensure that the motorcycle is parked on a flat and firm surface.
- Loosen the clamping screws (1) of the stand adopters.
- Move away the adopters (2 & 3) in such way that the swing arm fits between them (ref. Fig. 84).
- Ensure that the axle is not covered.
- Position the stand (ref. Fig. 85).



Fig. 84

- Make sure that the vehicle is secured so that it cannot topple sideways.
- Push the stand down until the motorcycle is standing upright and the handle of auxiliary stand is resting on the floor properly.



Fig. 85

Caution

When raising the motorcycle, make sure that the vehicle is secured so that it cannot topple sideways.

TVS Motor Company Limited ('the Company') gives this warranty with respect to the TVS Apache RR 310 manufactured by the Company.

While the Company has taken every care to maintain quality in the manufacture of the TVS Apache RR 310, the above said warranty is subject to other terms of warranty:

- **Standard Warranty** - During 24 months from the date of purchase or during the first 30,000 km of run*
- **Additional Warranty** - During 36 months from the completion of standard warranty or during the first 50,000 km of run**.

The vehicle in the hands of original retail purchaser, whichever is earlier, the parts of the vehicle covered under warranty which prove to the satisfaction of the Company to have a manufacturing defect will be repaired or replaced free of cost.

The Company's obligation under this warranty is limited to repairing or replacing, free of cost, those parts of the vehicle which upon examination by the Company may prove to the Company's satisfaction to have a manufacturing defect, and in such cases the Company's decision either to repair or replace the affected parts will be final. In the event of replacement of parts, the Company also reserves the right to use parts of the same brand as the affected parts or any other brand which is used by the Company in the course of manufacture. All parts replaced under this warranty will become the property of the Company and must be returned to the company.

Limitations of Warranty:

This warranty shall not apply to following condition:

1. Any natural wear and tear, including without limitation, aging.
2. Warranty claims on proprietary items such as tyres and batteries etc., should be referred by the user directly on the respective manufacturer, as per their warranty terms and the Company shall not be liable in any manner in respect to the same.
 - Battery warranty for "MF type (Maintenance Free)" is applicable for a period of 21 months from the date of charging or 18 months from the date of sale or 20,000 kms, whichever is earlier.
 - Battery warranty for "Lead Acid type" is applicable for a period of 15 months from date of charging or 12 months from date of sale or 10000 kms whichever is earlier.



3. Parts repaired or replaced under this warranty are warranted only throughout the remainder of the original warranty period.
4. The Company is not liable for any delay in servicing due to reasons beyond the control of the Company or any of its Authorised Main Dealers.
5. In any event, the Company is not liable for indirect, remote, incidental or consequential damages.
6. The Company may make any modification or improvement to vehicles in future production at any time without prior notice and without any obligation to install the same on vehicles previously dispatched for sale.
7. Any claim under this warranty will lie only when the customer:
 - takes his vehicle to an Authorised Main Dealer of the Company and reports the problem he / she felt in the vehicle to enable the Authorised Main Dealer to inspect the same and assess the cause for the reported problems.
8. This is the only warranty given by the Company for the TVS Apache RR 310. No employee, Dealer or other person is authorised to extend or enlarge this warranty.

Warning

Modifications to this vehicle not approved by the TVS Motor Company may cause loss of performance and render it unsafe for use and disqualifies for warranty coverage also.

Note

This warranty is applicable only for the vehicles availing warranty service (periodic service) when it falls due at TVS Motor Company Authorised Main Dealer only.

Following Toll Free numbers can be contacted for battery related queries if any:

Incase of EXIDE battery, call :- 1800 103 5454

Incase of TATA GREEN battery, call :- 1800 419 8888

Incase of AMCO battery, call :- 1800 425 0096

Incase of AMARON battery, call :- 1800 425 5858

Standard Warranty (24 months or first 30,000 km) - List of parts not covered under warranty*

ITEM	WHAT TO CHECK FOR
Eninge	-
Normal Maintenance Operations	Engine tune-up, decarbonizing, fuel system cleaning, oil and coolant changes, head light focusing, fastener re-tightening, tuning of EFI system, clutch, brakes, greasing of steering system and pivot pins as well as other normal adjustments.
Wear and Tear Items	Chain, sprockets, clutch and brake linings, fasteners, shims, washers, oil seals, gaskets etc.
Electrical	Fuse, LEDs are only in head lamp, tail lamp, tsl
Service Maintenance Parts	Oil filter, spark plug, air filter, oil, coolant, clamps
Rubber, Rexine and Plastic Items	All hoses , pipes and plastic aesthetics
Proprietary Items	Battery and tyres (the warranty terms are subject to our agreement with proprietary OEM) (Battery warranty for “MF type (Maintenance Free)” is applicable for a period of 21 months from the date of charging or 18 months from the date of sale or 20,000 kms, whichever is earlier). (Battery warranty for “Lead Acid type” is applicable for a period of 15 months from date of charging or 12 months from date of sale or 10000 kms whichever is earlier).
Others Factors	Parts of the vehicle getting affected due to atmospheric effect / environmental factors (rusting, paint peel off etc.). However, depending on the vehicle usage condition, warranty would be accepted up to 2 years from the date of purchase.

Standard Warranty (24 months or first 30,000 km) - List of parts not covered under warranty*

ITEM	WHAT TO CHECK FOR
Others Factors	Parts of the vehicle which have been tampered with, altered, repaired or replaced by persons not authorised by the Company and which in the sole judgement of the Company affect the performance of the vehicle.
	Parts which are used in conjunction with parts not made or recommended by the Company.
	Parts suffering damage or resultant damage by accident, misuse, negligent treatment, use of bad quality lubricants or coolant or impure fuel or by omission to follow the guidance and instructions contained in this owner's manual.
	Vehicles on which engine number or chassis number is deleted, defaced or altered. Vehicles on which any warranty service including scheduled pay service is not availed when it falls due (at TVS Motor Company Authorised Main Dealer).
	Vehicles sold or transferred by original retail purchaser. Vehicles used for racing or any competition or used otherwise than for ordinary personal transportation. Vehicles which have been taken out of India. Vehicles affected by natural calamities like flood, earthquake, tsunami, storm etc,.
	If the vehicle has been used for commercial purpose like taxi or used for rental or hiring or any other purpose other than regular personal transportation.

Additional Warranty (36 months or first 50,000 km) - List of parts not covered under warranty**

ITEM	WHAT TO CHECK FOR
Engine	Guide cam chain, tensioner cam chain, cam chain, valves (for carbon deposition alone), finger follower and Stem oil seal
Normal Maintenance Operations	Engine tune-up, decarbonizing, fuel system cleaning, oil and coolant changes, head light focusing, fastener re-tightening, tuning of EFI system, clutch, brakes, silencer (aesthetic failures), suspensions (leakage failures), greasing of steering system and pivot pins as well as other normal adjustments
Wear and Tear Items	Chain, sprockets, clutch and brake linings, control cables fasteners, shims, washers, oil seals, gaskets etc.
Electrical	Fuse, headlamp, tail lamp, TSL, control switches, instrument cluster, wheel speed sensor, ignition coil, injector, relays and horn.
Service Maintenance Parts	Oil filter, spark plug, air filter, oil, coolant, clamps
Rubber, Rexine and Plastic Items	All hoses , pipes and plastic aesthetics
Proprietary Items	Battery and tyres (the warranty terms are subject to our agreement with proprietary OEM) (Battery warranty for "MF type (Maintenance Free)" is applicable for a period of 21 months from the date of charging or 18 months from the date of sale or 20,000 kms, whichever is earlier). (Battery warranty for "Lead Acid type" is applicable for a period of 15 months from date of charging or 12 months from date of sale or 10000 kms whichever is earlier).

Additional Warranty (36 months or first 50,000 km) - List of parts not covered under warranty**

ITEM	WHAT TO CHECK FOR
Others Factors	Parts of the vehicle getting affected due to atmospheric effect / environmental factors (rusting, paint peel off etc.). However, depending on the vehicle usage condition, warranty would be accepted up to 2 years from the date of purchase.
	Parts of the vehicle which have been tampered with, altered, repaired or replaced by persons not authorised by the Company and which in the sole judgement of the Company affect the performance of the vehicle.
	Parts which are used in conjunction with parts not made or recommended by the Company.
	Parts suffering damage or resultant damage by accident, misuse, negligent treatment, use of bad quality lubricants or coolant or impure fuel or by omission to follow the guidance and instructions contained in this owner's manual.
	Vehicles on which engine number or chassis number is deleted, defaced or altered. Vehicles on which any warranty service including scheduled pay service is not availed when it falls due (at TVS Motor Company Authorised Main Dealer).
	Vehicles sold or transferred by original retail purchaser. Vehicles used for racing or any competition or used otherwise than for ordinary personal transportation. Vehicles which have been taken out of India. Vehicles affected by natural calamities like flood, earthquake, tsunami, storm etc.,
	If the vehicle has been used for commercial purpose like taxi or used for rental or hiring or any other purpose other than regular personal transportation.

Service Information

There are five services planned for your TVS Apache RR 310 during the warranty period. Of these, first three are free services for which labour charges are free. In addition to these three free services, we have a scheme of two pay services. For keeping maintenance track of your vehicle, a service record sheet is also attached. Please have the record sheet filled by the Dealer who is carrying out the maintenance service.

Before you avail your first free service, please enter the particulars of your vehicle on the left side of this page. This will be useful for any reference.

For availing any of the warranty services, please take your vehicle and your owner's manual to any of our Authorised Main Dealer. After completing the warranty service, for your record, the Authorised Main Dealer will affix their stamp on last column of record sheet.

Periodic maintenance always helps good performance of an automobile and our services are planned to keep your TVS Apache RR 310 performing good.

Please note that carrying out the services for your vehicle at scheduled intervals is necessary for availing warranty.

And please also remember that, after the services are over, periodic servicing of your vehicle at appropriate intervals, depending upon its extent of use, will keep your vehicle at its best level of performance.

In case need any clarification or assistance, please feel free to write to us mentioning the frame number, engine number and the date of purchase of your vehicle also the name and place of the Authorised Main Dealer from whom you bought the vehicle and getting it serviced.

Service Department

TVS MOTOR COMPANY LIMITED

P.O.Box No. 4, Harita, Hosur - 635109,

TAMILNADU, INDIA.

Toll free no. :- 1800-258-7111

Pre-Delivery Inspection

Sl. No.	Description
1	Inspect the vehicle for any visible damages / scratches
2	Inspect the battery charge and terminals connections
3	Ensure first aid kit and tool kit placed in the vehicle
4	Install left and right side mirrors
5	Inspect drive chain slackness and adjust if required
6	Inspect front and rear tyre pressure and inflate to specification if required.
7	Fill the fuel in the vehicle
8	Inspect the startability of the vehicle
9	Inspect and ascertain the working of all lamps and horn
10	Inspect head lamp focus and adjust if required
11	Conduct engine start suppression test
12	Test drive vehicle and ensure proper working of all controls and system
13	Clean the vehicle thoroughly
14	Using diagnostic tool, ensure there is no error codes
15	Code the service interval (distance and time) using diagnostic tool
16	Change the menu in cluster to odometer menu before handing over the vehicle to the customer
17	Explain of the product features and operations to the customer
18	Inspect the rear brake pedal free play and adjust if required
19	Check the front wheel and rear wheel freeness
20	Ensure any additional points communicated by TVS Motor Company Limited during the course

Planned Service Schedule (kms or month whichever of the two occurs early)*

Sl.No.	Service	Type	Kms	Months
1	1st Service	Free	1000	2
2	2nd Service	Free	5000	6
3	3rd Service	Free	10000	12
4	4th Service	Pay	15000	18
5	5th Service	Pay	20000	24
6	6th Service	Pay	25000	30
7	7th Service	Pay	30000	36
8	8th Service	Pay	35000	42
9	9th Service	Pay	40000	48
10	10th Service	Pay	45000	54
11	11th Service	Pay	50000	60

Note

Free service entitles the customer to avail service as detailed in service instructions at free of labour charge. Cost of oil, coolant, brake fluid and other materials for the free service is chargeable. Charge for the pay services, cost of oil, coolant, brake fluid and other materials for the pay service should be borne by the customer.

* Please remember that, after the above schedule, periodic servicing of your vehicle at appropriate intervals, depending upon its extent of use, will keep your vehicle at its best level of performance.



Busy Life? Easy Servicing!

Now, service your bike anywhere, anytime.

- ★ Service the vehicle at your door step.
- ★ Available for regular maintenance or breakdown service only.
- ★ Offered at nominal convenience charges.

Contact your nearest Dealership for details.[†]

[†]Facility available at selected Dealerships only. Terms and conditions apply

Recommended Fuel and Lubricants

Fuel	
Recommended fuel grade	BSVI ES Gasoline (containing upto 20% of ethanol by volume)
Fuel capacity (usable)	11 ± 0.5 ltr
Minimum required quantity of fuel	2 ltr
Engine Oil	
Recommended manufacturer	TVS / MOTUL
Recommended grade	TVSMTRU4 SAE 15W50 Synthetic oil / MOTUL 15W50 3000 4T Plus MA2 oil
Recommended quantity	1700 ml (fresh assembly / full drain along with filter change)
Coolant	
Recommended manufacturer	Glysantine
Recommended grade	G48
Recommended quantity	1 litre (coolant and distilled water ratio 50:50)
Cone set grease	
Recommended manufacturer	As recommended by TVS Motor Company
Recommended grade	BEM 34-132
Recommended quantity	15 gm (in sachet)

Recommended Fuel and Lubricants

Front fork oil	
Recommended manufacturer	Kayaba
Recommended grade	KHL 15-10
Recommended quantity	LH - 440 ± 2 ml, RH - 480 ± 2 ml
Chain cleaner	
Recommended manufacturer	MOTUL
Recommended grade	C1
Cone set grease	
Recommended manufacturer	MOTUL
Recommended grade	C2
Brake Fluid	
Recommended manufacturer	BASF HYDRAULAN 404 / EQUIVALENT
Recommended grade	DOT 4

Engine

Bore	80 mm
Stroke	62.1 mm
Displacement	312.12
Compression ratio	12.17 ± 0.3 : 1
No. of valves	4
Maximum power (Urban and Rain mode) (Sport and Track mode)	21 kW @ 7900 rpm 28 kW @ 9800 rpm
Maximum torque (Urban and Rain mode) (Sport and Track mode)	28.6 Nm @ 7800 rpm 26 Nm @ 7500 rpm
Maximum speed (Urban and Rain mode) (Sport and Track mode)	135 km/h 164 km/h
Engine idling rpm	1700 ± 200 rpm
Idling CO%	CO < 0.5%
Idling HC ppm	HC < 500 ppm
Camshaft	Double over head camshaft
Fuel feed	Closed loop EFI system
Cooling system	Liquid cooling
Air filter	Dry paper type

Engine

Oil filter	Wire mesh and Micronic paper filter
Lubrication system	Wet sump lubrication
Starting system	Electric starter

Transmission

Clutch system	Wet multi plate type
Gear shift pattern	One down five up
Number of gears	Six speed, toe shift
Primary transmission	Spur gears
Secondary transmission	Chain and sprockets
First gear ratio	3.000
Second gear ratio	2.06
Third gear ratio	1.59
Fourth gear ratio	1.29
Fifth gear ratio	1.10
Sixth gear ratio	0.95
Primary reduction	3.083
Secondary reduction	2.625

Dimension

Overall length	1994 ± 20 mm
Overall width	830 ± 10 mm
Overall height	1154 ± 10 mm
Saddle height	800 ± 10 mm
Ground clearance	182 ± 5 mm
Wheel base	1357 ± 10 mm
Kerb weight	174 kg
Pay load	130 kg
Gross vehicle weight	304 kg

Frame and Suspension

Frame type	Trellis type frame
Front suspension	USD fork 41 mm diameter
Rear suspension	Solid Die cast Aluminium swing arm directly hinged monoshox, pre-load adjustable.
Fork stroke length	140 mm
Rear suspension travel	138 mm
Steering angle	$34^{\circ} \pm 2^{\circ}$
Caster angle	$25^{\circ} \pm 1^{\circ}$
Turning radius	2500 ± 200 mm
Gradability	$\geq 10^{\circ}$
Banking angle	$58^{\circ} \pm 1^{\circ}$

Wheels and Brakes

Brakes	
Brakes type	Disc brake with ABS
Front brake size	Hand operated 300 mm disc
Rear brake size	Foot operated 240 mm disc
Wheel	
Front tyre make and model	MICHELIN M/C 54 W - Road 5 Radial
Rear tyre make and model	MICHELIN M/C 66 W - Road 5 Radial
Front tyre size	110/70-R17 M/C 54H Tubeless / 110/70 ZR17 M/C 54W Tubeless
Rear tyre size	150/60-R17 M/C 66H Tubeless / 150/60 ZR17 M/C 66W Tubeless
Front tyre pressure	2.25 kg (32 PSI) for both solo and dual
Rear tyre pressure	2.25 kg (32 PSI) for both solo and dual

Free Plays

Free plays	
Clutch free play	8 - 12 mm
Drive chain free play	30 - 40 mm

Electricals

Type	Three phase AC generator
Ignition system	Dynamically controlled - high energy integrated ignition system
Spark plug	NGK (LMAR9D - J)
Spark plug gap	0.8 ± 0.1 mm
Battery type	12V / 8 Ah MF wet charge type
Body earthing	Two grounds are mounted on engine body (1. Engine ground and 2. Ignition ground) and one ground mounted on fuel tank
Generator	12V, 290W
Head lamp	12V, LED (35W)
Position lamp	12V, LED (5W)
Tail / brake lamp	12V, LED (2W / 2W approx.)
Turn signal lamp	12V, LED (2W each)
Number plate lamp	12V, LED (1.5W)
Instrument panel	TFT / LED indicators
Horn type	12V, DC two numbers
Fuse	Mini fuse - 7.5A x 2, 10A x 2, 15A x 2, and 30A x 1
Voltage regulator	Three phase shunt full DC RR unit

Important Torque Details

Front wheel	
Quick release axle locking screw	50 ± 7 Nm
Axle holder clamping screws	19 ± 3 Nm
Caliper assembly mounting bolts	28 ± 4.2 Nm
Rear wheel	
Drive chain adjuster screw lock nuts	19 ± 3 Nm
Rear wheel quick release nut	100 ± 15 Nm
Swing arm	
Swing arm axle mounting nut	135 ± 20.5 Nm
Rear shock absorber top mounting bolt	56 ± 8.4 Nm
Rear shock absorber bottom mounting bolt	56 ± 8.4 Nm
Rear tyre pressure	2.25 kg (32 PSI) for both solo and dual

Basic Troubleshooting

Difficulty in starting the engine or engine not starting

Possible cause	Rectification
Side stand is in ON and gear engaged	Release the side stand
Engine kill switch is ON	Turn off the engine kill switch (ref. page 39)
Gear applied and clutch not disengaged	Either apply the clutch or bring the transmission to neutral position.
No fuel in the fuel tank	Refuel (ref. page 116)
Battery discharged	Recharge the battery or fix a new battery if the old battery is not getting charged.

Dear Customer,

It is mandatory under the Motor Vehicles Act to insure all motor vehicles. No motor vehicle can be used in a public place without a valid policy of insurance issued by an authorised insurer. Driving a motor vehicle without any such insurance is an offense under Motor Vehicles Act.

To assist our Customers on their insurance requirements such as the prompt issue and renewal of policies as well as expeditious settlement of claims if any, our preferred insurers are:



TVS CONNECT APP



'TVS CONNECT' mobile app of your TVS RR310 vehicle can be downloaded from the Google Play and the AppStore® by searching the key word 'TVS CONNECT' else by scanning the below QR code.



Android

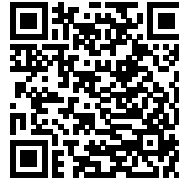

IOS



TVS MOTOR COMPANY LIMITED. P.B. No.4, Harita, Hosur, 635109, Tamil Nadu, India.
Telephone: +91 (4344) 276780. Fax: +91 (4344) 276878 / 277311 www.tvsapache.com